



Summary

1 	2 	3 	6000 11x5.5, 13x6.5, 15x7.5, 22x11, 28x14 mm	1 	2 	3 	6215 18 mm	1 	2 	3 	6722 16, 20, 30 mm
			6002 10x7, 15x11.5 mm				6225 10, 18, 28 mm				6723 16, 28 mm
			6007 7x4, 9x5 mm				6228 10.3x10, 14.4x14, 18x17.5, 28, 40 mm				6727 18 mm
			6010 11x5.5, 13x6.5, 17x8.5, 21x10.5 mm				6301 6, 8, 10 mm				6735 26x16, 32x20 mm
			6012 11x10, 15.4x14 mm				6401 8, 12, 14 mm				6744 12, 14, 18, 20 mm
			6015 13, 17, 21, 50 mm				6428 6, 8, 12 mm				6754 18 mm
			6039 25, 38 mm				6460 20 mm				6790 30, 40 mm
			6049 20, 30 mm				6620 20, 30, 40 mm				6791 25, 34 mm
			6058 18, 25 mm				6621 18, 28 mm				6860 12x10, 20x16, 38x29 mm
			6090 16x11, 22x15 mm				6650 22 mm				6864 40x30 mm
			6091 28, 38, 50 mm				6656 19, 27, 39 mm				6866 20 mm
			6100 24x12, 34x20 mm				6657 16x27, 23.5x39 mm				6900 13.5x20, 30x45 mm
			6106 16, 22, 28, 38, 50 mm				6670 18, 24, 50 mm				6901 30x45 mm
			6110 30x14, 40x18 mm				6680 14, 20, 40 mm				6902 16.5x25 mm
			6150 30, 50 mm				6690 23, 27, 39 mm				6904 30, 45 mm
			6190 23, 35 mm				6704 20, 25, 30, 35 mm				6905 30, 45 mm
			6191 19, 27, 48 mm				6714 20, 28, 40 mm				6906 20, 40 mm
			6210 12, 17 mm				6721 16, 20, 28, 40 mm				6908 30, 40 mm

1 Front View 2 Side View 3 Back View

If *1 Front View* or *3 Back View* highlighted in grey: the surface effect is applied on the respective side

If *2 Side View* highlighted in grey: not defined on which side the surface effect is applied (for all symmetric and some asymmetric articles)

6721: 16, 20 mm: no defined side for surface effect; 28, 40 mm surface effect on *3 Back View*.

6864: Reverse effect *V* is the standard version and therefore highlighted

Pendants

6000

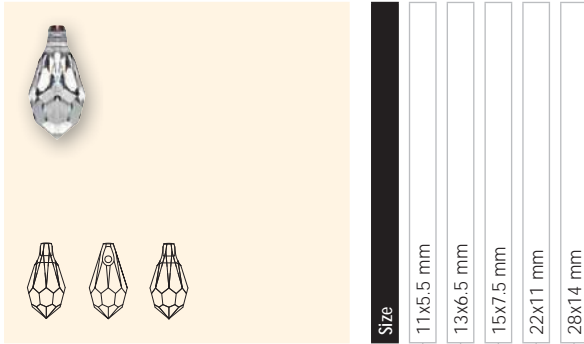

Size
11x5.5 mm
13x6.5 mm
15x7.5 mm
22x11 mm
28x14 mm

Colour

Crystal (001)	<input type="checkbox"/>	<input type="checkbox"/>	<input type="checkbox"/>	<input type="checkbox"/>	<input type="checkbox"/>
Crystal AB (001 AB)	<input type="checkbox"/>	<input type="checkbox"/>	<input type="checkbox"/>	<input type="checkbox"/>	<input type="checkbox"/>
Jet (280)	<input type="checkbox"/>	<input type="checkbox"/>	<input type="checkbox"/>	<input type="checkbox"/>	<input type="checkbox"/>
Amethyst (204)	<input type="checkbox"/>	<input type="checkbox"/>	<input type="checkbox"/>	<input type="checkbox"/>	<input type="checkbox"/>
Aquamarine (202)	<input type="checkbox"/>	<input type="checkbox"/>	<input type="checkbox"/>	<input type="checkbox"/>	<input type="checkbox"/>
Emerald (205)	<input type="checkbox"/>	<input type="checkbox"/>	<input type="checkbox"/>	<input type="checkbox"/>	<input type="checkbox"/>
Light Siam (227)	<input type="checkbox"/>	<input type="checkbox"/>	<input type="checkbox"/>	<input type="checkbox"/>	<input type="checkbox"/>
Rose (209)	<input type="checkbox"/>	<input type="checkbox"/>	<input type="checkbox"/>	<input type="checkbox"/>	<input type="checkbox"/>
Sapphire (206)	<input type="checkbox"/>	<input type="checkbox"/>	<input type="checkbox"/>	<input type="checkbox"/>	<input type="checkbox"/>
Siam (208)	<input type="checkbox"/>	<input type="checkbox"/>	<input type="checkbox"/>	<input type="checkbox"/>	<input type="checkbox"/>
Tanzanite (539)	<input type="checkbox"/>	<input type="checkbox"/>	<input type="checkbox"/>	<input type="checkbox"/>	<input type="checkbox"/>
Topaz (203)	<input type="checkbox"/>	<input type="checkbox"/>	<input type="checkbox"/>	<input type="checkbox"/>	<input type="checkbox"/>

6002

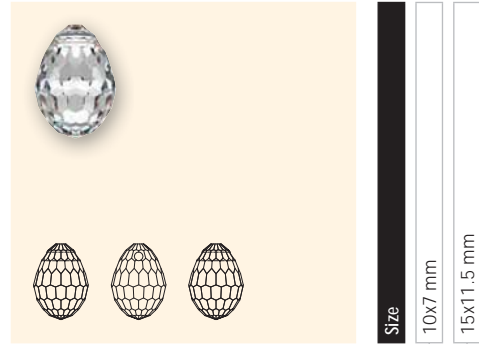

Size
10x7 mm
15x11.5 mm

Colour

Crystal (001)	<input type="checkbox"/>	<input type="checkbox"/>
Crystal AB (001 AB)	<input type="checkbox"/>	<input type="checkbox"/>

6007 Small Briolette Pendant

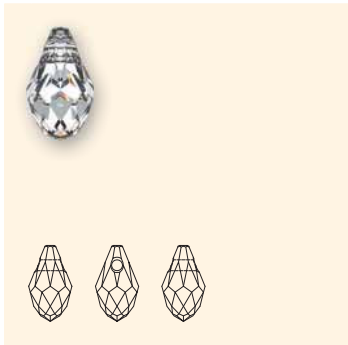

Size
7x4 mm
9x5 mm

Colour

Crystal (001)	<input type="checkbox"/>	<input type="checkbox"/>
Crystal AB (001 AB)	<input type="checkbox"/>	<input type="checkbox"/>
Crystal Copper (001 COP)	<input type="checkbox"/>	<input type="checkbox"/>
Crystal Golden Shadow (001 GSHA)	<input type="checkbox"/>	<input type="checkbox"/>
Crystal Moonlight (001 MOL)	<input type="checkbox"/>	<input type="checkbox"/>
Crystal Silver Shade (001 SSHA)	<input type="checkbox"/>	<input type="checkbox"/>
Jet (280)	<input type="checkbox"/>	<input type="checkbox"/>
Light Rose (223)	<input type="checkbox"/>	<input type="checkbox"/>
Siam (208)	<input type="checkbox"/>	<input type="checkbox"/>

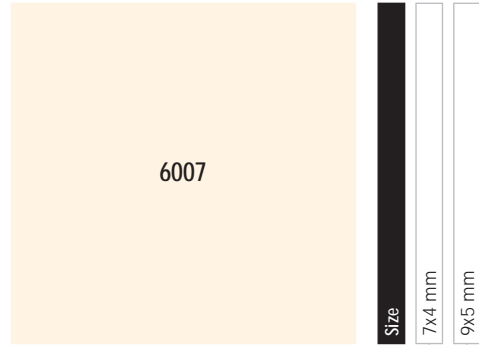

Size
7x4 mm
9x5 mm

Colour

Tanzanite (539)	<input type="checkbox"/>	<input type="checkbox"/>
Topaz (203)	<input type="checkbox"/>	<input type="checkbox"/>

Pendants

6010 Briolette Pendant



Size
11x5.5 mm
13x6.5 mm
17x8.5 mm
21x10.5 mm

Colour	11x5.5 mm	13x6.5 mm	17x8.5 mm	21x10.5 mm
Crystal (001)	■	■	■	■
Crystal AB (001 AB)	■	■	■	■
Crystal Copper (001 COP)	■	■	■	■
Crystal Golden Shadow (001 GSHA)	■	■	■	■
Crystal Moonlight (001 MOL)	■	■	■	■
Crystal Silver Shade (001 SSHA)	■	■	■	■
Jet (280)	■	■	■	■
Air Blue Opal (285)	■	■		
Amethyst (204)	■	■	■	
Aquamarine (202)	■	■	■	
Cyclamen Opal (398)	■	■	■	
Dark Indigo (288)	■	■		
Erinite (360)	■	■	■	
Fern Green (291)	■	■	■	
Fuchsia (502)	■	■	■	
Greige (284)	■	■		
Indian Pink (289)	■			
Jonquil (213)	■	■	■	
Light Amethyst (212)	■	■	■	
Light Colorado Topaz (246)	■	■	■	
Light Grey Opal (383)	■	■	■	
Light Rose (223)	■	■	■	
Light Sapphire (211)	■	■	■	
Mocca (286)	■	■		
Padparadscha (542)	■	■	■	
Palace Green Opal (393)	■	■	■	
Peridot (214)	■	■	■	
Provence Lavender (283)	■	■		
Sand Opal (287)	■	■		
Siam (208)	■	■		
Tanzanite (539)	■	■	■	
Topaz (203)	■	■		

6012 Flat Briolette Pendant



Size
11x10 mm
15.4x14 mm

Colour	11x10 mm	15.4x14 mm
Crystal (001)	■	■
Crystal AB (001 AB)	■	■
Crystal Golden Shadow (001 GSHA)	■	■
Crystal Silver Shade (001 SSHA)	■	■
Jet (280)	■	■
Aquamarine (202)	■	■
Light Rose (223)	■	■
Olivine (228)	■	■
Ruby (501)	■	■

6015 Polygon Drop



Size
13 mm
17 mm
21 mm
50 mm

Colour	13 mm	17 mm	21 mm	50 mm
Crystal (001)	■	■	■	■
Crystal AB (001 AB)	■	■	■	■
Crystal Golden Shadow (001 GSHA)	■	■	■	■
Crystal Silver Shade (001 SSHA)	■	■	■	■
Jet (280)	■	■	■	■
Amethyst (204)	■	■		
Aquamarine (202)	■	■	■	
Light Amethyst (212)	■	■	■	
Light Azore (361)	■	■	■	
White Opal (234)	■	■	■	

Pendants

6039 Disk Pendant

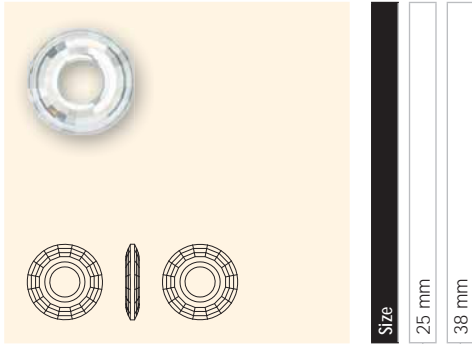

Colour		Size
<input type="checkbox"/>	Crystal (001)	25 mm
<input type="checkbox"/>	Crystal Copper (001 COP)	38 mm
<input type="checkbox"/>	Crystal Golden Shadow (001 GSHA)	
<input type="checkbox"/>	Crystal Red Magma (001 REDM)	
<input type="checkbox"/>	Crystal Silver Shade (001 SSHA)	
<input type="checkbox"/>	Jet (280)	
<input type="checkbox"/>	Aquamarine (202)	
<input type="checkbox"/>	Peridot (214)	

6049

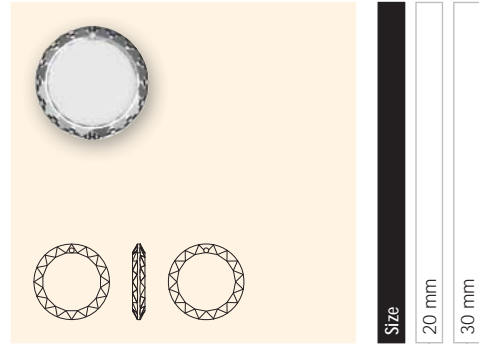

Colour		Size
<input type="checkbox"/>	Crystal (001)	20 mm
<input type="checkbox"/>	Crystal AB (001 AB)	30 mm

6058 Metro Pendant

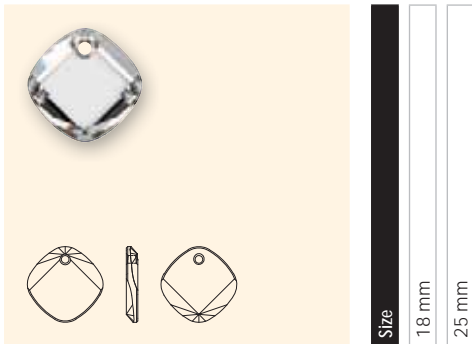

Colour		Size
<input type="checkbox"/>	Crystal (001)	18 mm
<input type="checkbox"/>	Crystal Golden Shadow (001 GSHA)	25 mm
<input type="checkbox"/>	Black Diamond (215)	

6090 Baroque Pendant



Colour		Size
<input type="checkbox"/>	Crystal (001)	16x11 mm
<input type="checkbox"/>	Crystal AB (001 AB)	22x15 mm
<input type="checkbox"/>	Crystal Golden Shadow (001 GSHA)	
<input type="checkbox"/>	Jet (280)	
<input type="checkbox"/>	Amethyst (204)	
<input type="checkbox"/>	Aquamarine (202)	
<input type="checkbox"/>	Black Diamond (215)	
<input type="checkbox"/>	Light Amethyst (212)	
<input type="checkbox"/>	Light Colorado Topaz (246)	
<input type="checkbox"/>	Light Rose (223)	
<input type="checkbox"/>	Light Topaz (226)	
<input type="checkbox"/>	Olivine (228)	
<input type="checkbox"/>	Ruby (501)	
<input type="checkbox"/>	Topaz (203)	

Pendants

6091 Flat Baroque Pendant

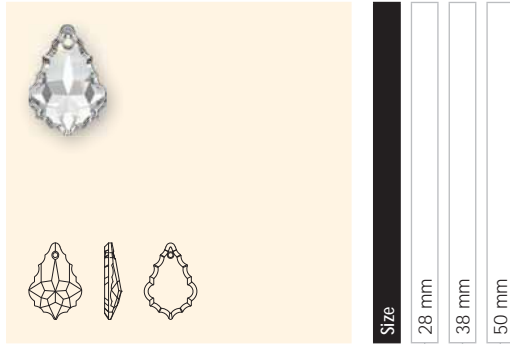

Colour	28 mm	38 mm	50 mm
Crystal (001)	■	■	■
Crystal AB (001 AB)	■	■	■
Crystal Golden Shadow (001 GSHA)	■	■	■
Crystal Silver Shade (001 SSHA)	■	■	■
Jet (280)	■	■	■

6100

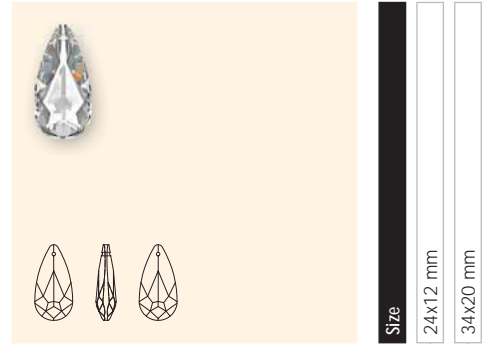

Colour	24x12 mm	34x20 mm
Crystal (001)	■	■
Crystal AB (001 AB)	■	■
Crystal Bermuda Blue (001 BBL)	■	■
Crystal Vitrail Light (001 VL)	■	■
Crystal Vitrail Medium (001 VM)	■	■
Fireopal (237)	■	■
Oceanblue (376)	■	■
Terrenum (377)	■	■

6106 Pear-shaped Pendant

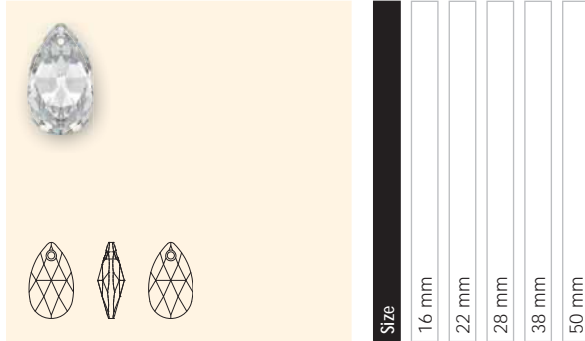

Colour	16 mm	22 mm	28 mm	38 mm	50 mm
Crystal (001)	■	■	■	■	■
Crystal AB (001 AB)	■	■	■	■	■
Crystal Copper (001 COP)	■	■	■	■	■
Crystal Golden Shadow (001 GSHA)	■	■	■	■	■
Crystal Red Magma (001 REDM)	■	■	■	■	■
Crystal Silver Shade (001 SSHA)	■	■	■	■	■
Jet (280)	■	■	■	■	■
Aquamarine (202)	■	■	■	■	■
Light Rose (223)	■	■	■	■	■
Light Topaz (226)	■	■	■	■	■
Peridot (214)	■	■	■	■	■
Ruby (501)	■	■	■	■	■
Tanzanite (539)	■	■	■	■	■
White Opal (234)	■	■	■	■	■

6110 Navette Pendant

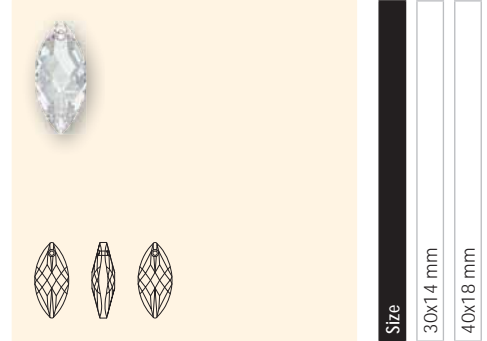

Colour	30x14 mm	40x18 mm
Crystal (001)	■	■
Crystal Copper (001 COP)	■	■
Crystal Golden Shadow (001 GSHA)	■	■
Crystal Red Magma (001 REDM)	■	■
Crystal Silver Shade (001 SSHA)	■	■
Jet (280)	■	■
Amethyst (204)	■	■
Aquamarine (202)	■	■
Light Amethyst (212)	■	■
Olivine (228)	■	■

Pendants

6150 Pegasus Pendant

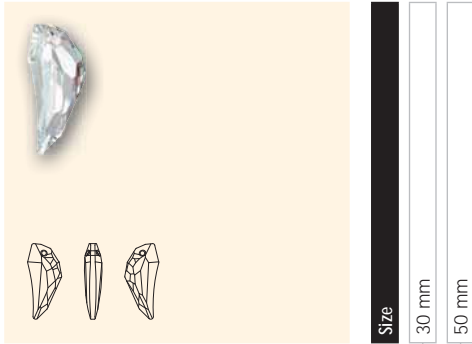

Size
30 mm
50 mm

Colour	
	Crystal (001)
	Crystal Copper (001 COP)
	Crystal Golden Shadow (001 GSHA)
	Crystal Moonlight (001 MOL)
	Crystal Satin (001 SAT)
	Crystal Silver Shade (001 SSHA)
	Jet (280)

6190 Rock Pendant

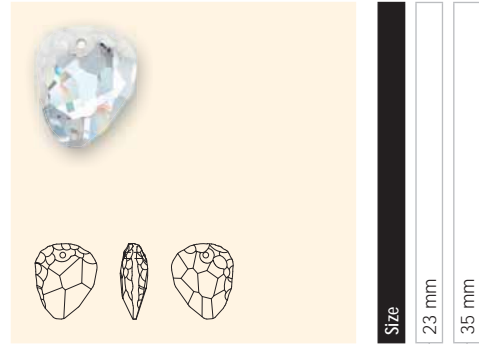

Size
23 mm
35 mm

Colour	
	Crystal (001)
	Crystal Copper (001 COP)
	Crystal Golden Shadow (001 GSHA)
	Crystal Moonlight (001 MOL)
	Crystal Silver Shade (001 SSHA)
	Jet (280)
	Amethyst (204)
	Black Diamond (215)
	Light Sapphire (211)
	Olivine (228)
	Rose (209)
	Topaz (203)

6191 Divine Rock Pendant



Size
19 mm
27 mm
48 mm

Colour	
	Crystal (001)
	Crystal Golden Shadow (001 GSHA)
	Crystal Red Magma (001 REDM)
	Crystal Silver Shade (001 SSHA)
	Jet (280)
	Aquamarine (202)
	Jonquil (213)
	Light Rose (223)
	Montana (207)
	Topaz (203)

6210



Size
12 mm
17 mm

Colour	
	Crystal (001)
	Crystal AB (001 AB)

Pendants

6215

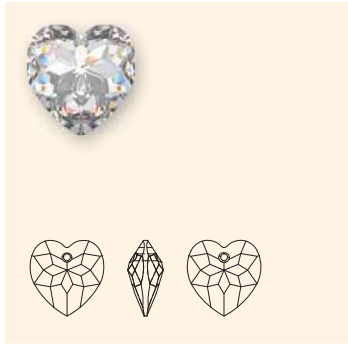

Size
18 mm

- Colour**
- Crystal (001)
 - Crystal AB (001 AB)
 - Crystal Red Magma (001 REDM)
 - Crystal Satin (001 SAT)

New!

6225



Size
10 mm
18 mm
28 mm

- Colour**
- Crystal (001)
 - Crystal Golden Shadow (001 GSHA)

Pendants

6228 XILION Heart Pendant

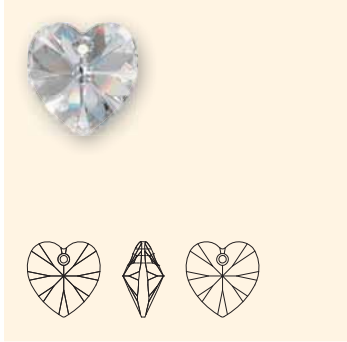

Size	10.3x10 mm	14.4x14 mm	18x17.5 mm	28 mm	40 mm
------	------------	------------	------------	-------	-------

Colour	10.3x10 mm	14.4x14 mm	18x17.5 mm	28 mm	40 mm
Crystal (001)	■	■	■	■	■
Crystal AB (001 AB)	■	■	■	■	■
Crystal Bermuda Blue (001 BBL)	■	■	■	■	■
Crystal Golden Shadow (001 GSHA)	■	■	■	■	■
Crystal Heliotrope (001 HEL)	■	■	■	■	■
Crystal Moonlight (001 MOL)	■	■	■	■	■
Crystal Red Magma (001 REDM)	■	■	■	■	■
Crystal Silver Shade (001 SSHA)	■	■	■	■	■
Crystal Vitrail Light (001 VL)	■	■	■	■	■
Crystal Vitrail Medium (001 VM)	■	■	■	■	■
Jet (280)	■	■	■	■	■
Air Blue Opal (285)	■	■	■	■	■
Amethyst (204)	■	■	■	■	■
Amethyst AB (204 AB)	■	■	■	■	■
Aquamarine (202)	■	■	■	■	■
Aquamarine AB (202 AB)	■	■	■	■	■
Black Diamond (215)	■	■	■	■	■
Black Diamond AB (215 AB)	■	■	■	■	■
Blue Zircon (229)	■	■	■	■	■
Blue Zircon AB (229 AB)	■	■	■	■	■
Cyclamen Opal (398)	■	■	■	■	■
Dark Indigo (288)	■	■	■	■	■
Emerald (205)	■	■	■	■	■
Fern Green (291)	■	■	■	■	■
Fuchsia (502)	■	■	■	■	■
Fuchsia AB (502 AB)	■	■	■	■	■
Greige (284)	■	■	■	■	■
Indian Pink (289)	■	■	■	■	■
Jonquil (213)	■	■	■	■	■
Light Amethyst (212)	■	■	■	■	■
Light Rose (223)	■	■	■	■	■
Light Rose AB (223 AB)	■	■	■	■	■
Light Sapphire (211)	■	■	■	■	■
Light Siam (227)	■	■	■	■	■
Light Siam AB (227 AB)	■	■	■	■	■
Light Topaz (226)	■	■	■	■	■
Light Topaz AB (226 AB)	■	■	■	■	■
Olivine (228)	■	■	■	■	■
Olivine AB (228 AB)	■	■	■	■	■



Size	10.3x10 mm	14.4x14 mm	18x17.5 mm	28 mm	40 mm
------	------------	------------	------------	-------	-------

Colour	10.3x10 mm	14.4x14 mm	18x17.5 mm	28 mm	40 mm
Padparadscha (542)	■	■	■	■	■
Peridot (214)	■	■	■	■	■
Peridot AB (214 AB)	■	■	■	■	■
Provence Lavender (283)	■	■	■	■	■
Rosaline (508)	■	■	■	■	■
Rose (209)	■	■	■	■	■
Rose AB (209 AB)	■	■	■	■	■
Sapphire (206)	■	■	■	■	■
Sapphire AB (206 AB)	■	■	■	■	■
Siam (208)	■	■	■	■	■
Siam AB (208 AB)	■	■	■	■	■
Tanzanite (539)	■	■	■	■	■
Topaz (203)	■	■	■	■	■
Topaz AB (203 AB)	■	■	■	■	■
Violet (371)	■	■	■	■	■
Violet AB (371 AB)	■	■	■	■	■
White Opal (234)	■	■	■	■	■

Pendants

Pendants

6301

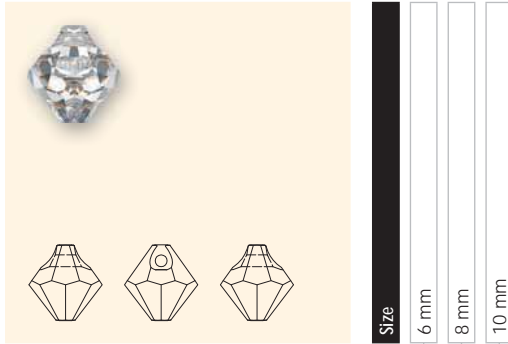

Colour	6 mm	8 mm	10 mm
Crystal (001)	■	■	■
Crystal AB (001 AB)	■	■	■
Crystal Golden Shadow (001 GSHA)	■	■	
Crystal Metallic Light Gold 2x (001 MLG2)	■	■	
Jet (280)	■	■	
Air Blue Opal (285)	■	■	
Amethyst (204)	■	■	
Aquamarine (202)	■	■	
Black Diamond (215)	■	■	
Cyclamen Opal (398)	■	■	
Dark Indigo (288)	■	■	
Fern Green (291)	■	■	
Greige (284)	■	■	
Indian Pink (289)	■	■	
Jonquil (213)	■	■	
Khaki (550)	■	■	
Light Amethyst (212)	■	■	
Light Colorado Topaz (246)	■	■	
Light Rose (223)	■	■	
Light Sapphire (211)	■		
Mocca (286)	■	■	
Padparadscha (542)	■	■	
Peridot (214)	■	■	
Provence Lavender (283)	■	■	
Rose (209)	■	■	
Siam (208)	■	■	
Tanzanite (539)	■	■	
Topaz (203)	■	■	
Violet (371)	■	■	

6401 Octagon Pendant

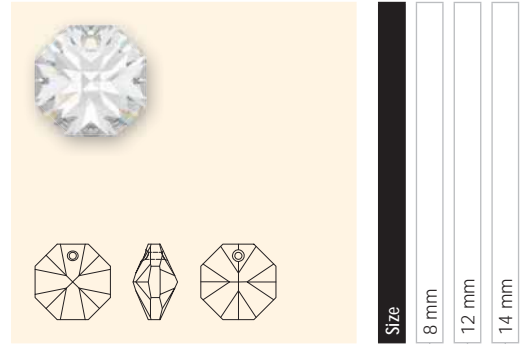

Colour	8 mm	12 mm	14 mm
Crystal (001)	■	■	■
Crystal AB (001 AB)	■	■	■
Crystal Copper (001 COP)	■		
Crystal Golden Shadow (001 GSHA)	■	■	
Crystal Silver Shade (001 SSHA)	■	■	
Jet (280)	■	■	
Aquamarine (202)	■	■	
Light Rose (223)	■	■	
Tanzanite (539)	■	■	

Pendants

6428 XILION Pendant

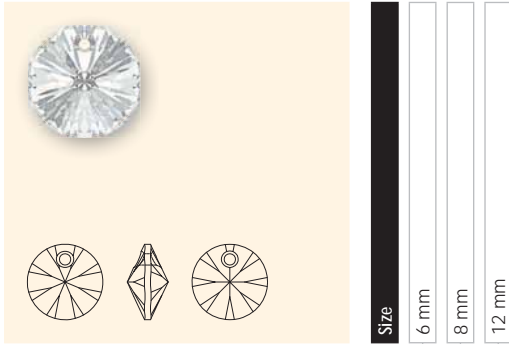

Colour	6 mm	8 mm	12 mm
Crystal (001)	■	■	■
Crystal AB (001 AB)	■	■	■
Crystal Copper (001 COP)	■	■	■
Crystal Golden Shadow (001 GSHA)	■	■	■
Crystal Metallic Light Gold 2x (001 MLG2)	■	■	■
Crystal Silver Shade (001 SSHA)	■	■	■
Jet (280)	■	■	■
Amethyst (204)	■	■	■
Aquamarine (202)	■	■	■
Chrysolite (238)	■	■	■
Cyclamen Opal (398)	■	■	■
Dark Indigo (288)	■	■	■
Fern Green (291)	■	■	■
Greige (284)	■	■	■
Indian Pink (289)	■	■	■
Light Colorado Topaz (246)	■	■	■
Light Siam (227)	■	■	■
Provence Lavender (283)	■	■	■
Rose (209)	■	■	■
Siam (208)	■	■	■
Violet (371)	■	■	■

6460 Column Pendant

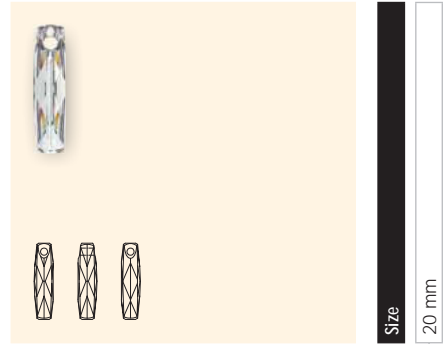

Colour	20 mm
Crystal (001)	■
Crystal AB (001 AB)	■
Crystal Copper (001 COP)	■
Crystal Golden Shadow (001 GSHA)	■
Crystal Satin (001 SAT)	■
Crystal Silver Shade (001 SSHA)	■

Pendants

6620 Avant-garde Pendant

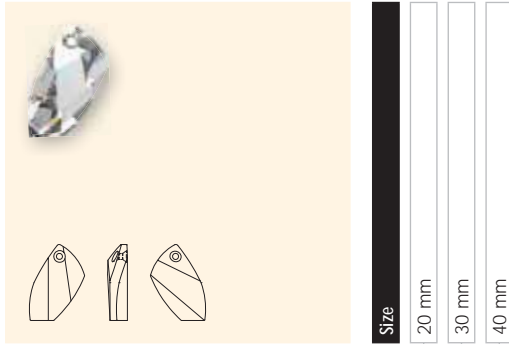

Colour	20 mm	30 mm	40 mm
Crystal (001)	■	■	■
Crystal AB (001 AB)	■		
Crystal Golden Shadow (001 GSHA)	■	■	■
Crystal Red Magma (001 REDM)		■	■
Crystal Silver Shade (001 SSHA)	■	■	■
Jet (280)	■	■	■
Aquamarine (202)	■		
Indicolite (379)	■		
Light Amethyst (212)	■		

6621 Twist Pendant

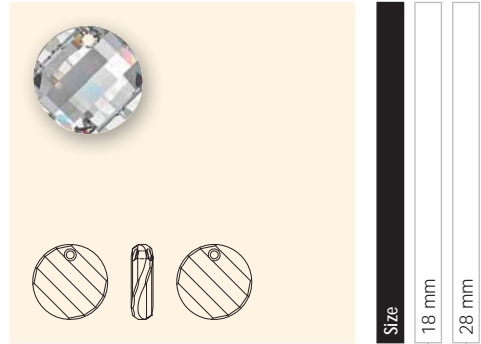

Colour	18 mm	28 mm
Crystal (001)	■	■
Crystal Copper (001 COP)	■	■
Crystal Golden Shadow (001 GSHA)	■	■
Crystal Moonlight (001 MOL)	■	■
Crystal Red Magma (001 REDM)	■	■
Crystal Silver Shade (001 SSHA)	■	■
Jet (280)	■	■
Amethyst (204)	■	
Aquamarine (202)	■	
Black Diamond (215)	■	
Jonquil (213)	■	
Light Rose (223)	■	
Peridot (214)	■	

6650 Cubist Pendant



Colour	22 mm
Crystal (001)	■
Crystal Copper (001 COP)	■
Crystal Golden Shadow (001 GSHA)	■
Crystal Moonlight (001 MOL)	■
Crystal Silver Shade (001 SSHA)	■
Jet (280)	■
Black Diamond (215)	■
Burgundy (515)	■
Light Amethyst (212)	■
Light Sapphire (211)	■
Peridot (214)	■
White Opal (234)	■

Pendants

6656 Galactic Vertical Pendant



Size
19 mm
27 mm
39 mm

Colour

Crystal (001)	■	■	■
Crystal Copper (001 COP)	■	■	■
Crystal Golden Shadow (001 GSHA)	■	■	■
Crystal Moonlight (001 MOL)	■	■	■
Crystal Red Magma (001 REDM)	■	■	■
Crystal Satin (001 SAT) <i>New!</i>	■	■	■
Crystal Silver Shade (001 SSHA)	■	■	■
Jet (280)	■	■	■
Aquamarine (202)	■	■	■
Jonquil (213)	■	■	■
Light Rose (223)	■	■	■
Peridot (214)	■	■	■
Tanzanite (539)	■	■	■
White Opal (234)	■	■	■

6657 Galactic Horizontal Pendant



Size
16x27 mm
23.5x39 mm

Colour

Crystal (001)	■	■
Crystal Copper (001 COP)	■	■
Crystal Golden Shadow (001 GSHA)	■	■
Crystal Red Magma (001 REDM)	■	■
Crystal Silver Shade (001 SSHA)	■	■
Jet (280)	■	■

Pendants

6670 De-Art Pendant

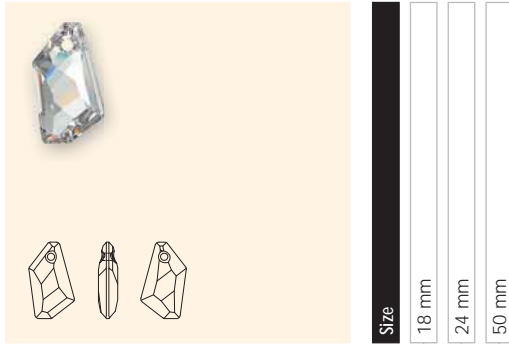

Colour	18 mm	24 mm	50 mm
Crystal (001)	■	■	■
Crystal AB (001 AB)	■	■	■
Crystal Copper (001 COP)	■	■	■
Crystal Golden Shadow (001 GSHA)	■	■	■
Crystal Silver Shade (001 SSHA)	■	■	■
Jet (280)	■	■	■
Amethyst (204)	■	■	
Aquamarine (202)	■	■	
Light Rose (223)	■	■	
Montana (207)	■	■	
Ruby (501)	■	■	

6680 Cosmic Pendant

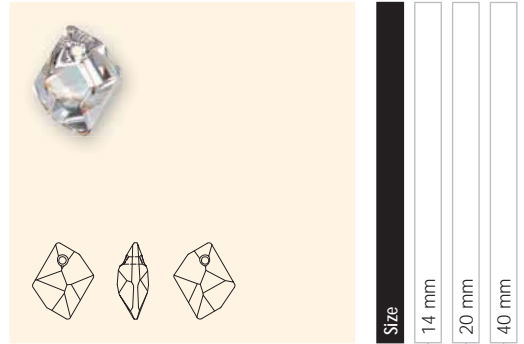

Colour	14 mm	20 mm	40 mm
Crystal (001)	■	■	■
Crystal AB (001 AB)	■	■	■
Crystal Copper (001 COP)	■	■	■
Crystal Golden Shadow (001 GSHA)	■	■	■
Crystal Red Magma (001 REDM)	■	■	■
Crystal Silver Shade (001 SSHA)	■	■	■
Jet (280)	■	■	■
Aquamarine (202)	■	■	
Light Rose (223)	■	■	
Ruby (501)	■	■	
Violet (371)	■	■	

6690 Wing Pendant

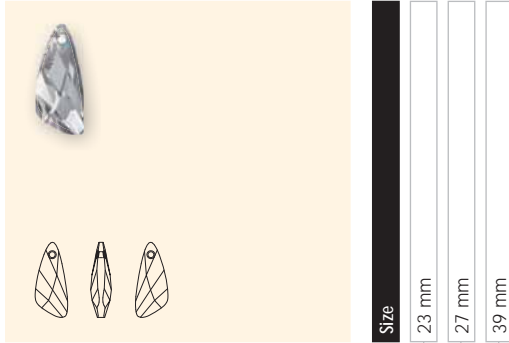

Colour	23 mm	27 mm	39 mm
Crystal (001)	■	■	■
Crystal AB (001 AB)	■	■	■
Crystal Copper (001 COP)	■	■	■
Crystal Golden Shadow (001 GSHA)	■	■	■
Crystal Red Magma (001 REDM)	■	■	■
Crystal Silver Shade (001 SSHA)	■	■	■
Jet (280)	■	■	■
Aquamarine (202)	■		
Capri Blue (243)	■		

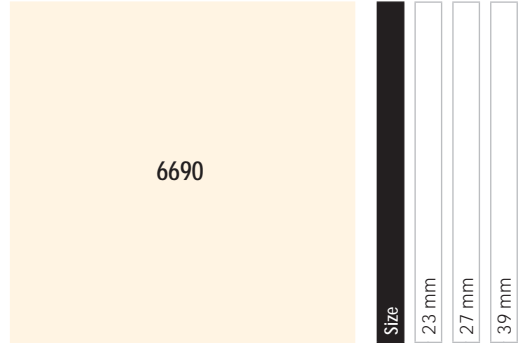

Colour	23 mm	27 mm	39 mm
Fuchsia (502)	■		
Light Colorado Topaz (246)	■		
Light Rose (223)	■		
Light Topaz (226)	■		
Peridot (214)	■		
Provence Lavender (283)	■	■	
Tanzanite (539)	■		

Pendants

6704 Snowflake Pendant



Colour		20 mm	25 mm	30 mm	35 mm
	Crystal (001)	■	■	■	■
	Crystal AB (001 AB)	■	■	■	■

6714 Star Pendant

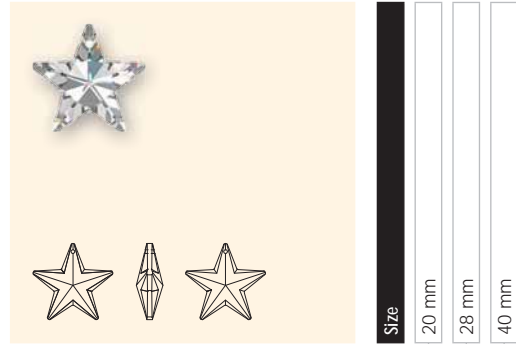

Colour		20 mm	28 mm	40 mm
	Crystal (001)	■	■	■
	Crystal AB (001 AB)	■	■	■
	Crystal Golden Shadow (001 GSHA)	■	■	■
	Jet (280)	■	■	■
	Light Sapphire (211)	■	■	■
	Rosaline (508)	■	■	■

6721 Starfish Pendant

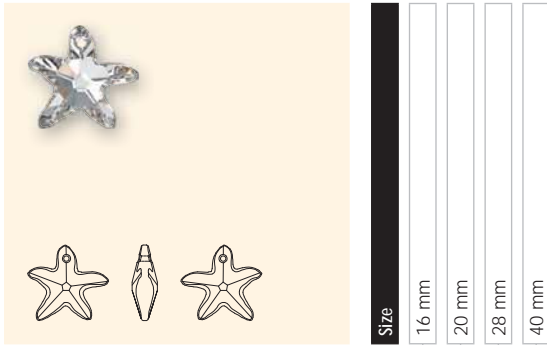

Colour		16 mm	20 mm	28 mm	40 mm
	Crystal (001)	■	■	■	■
	Crystal AB (001 AB)	■	■	■	■
	Crystal Golden Shadow (001 GSHA)	■	■	■	■
	Crystal Red Magma (001 REDM)	■	■	■	■
	Aquamarine (202)	■	■		
	Indicolite (379)	■	■		
	Light Amethyst (212)	■	■		
	Light Rose (223)	■	■		
	Peridot (214)	■	■		

6722 Moon Pendant

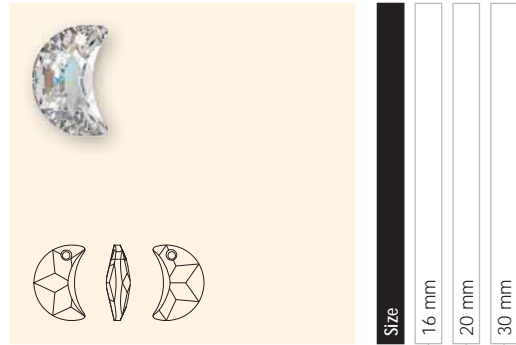

Colour		16 mm	20 mm	30 mm
	Crystal (001)	■	■	■
	Crystal AB (001 AB)	■	■	■
	Crystal Golden Shadow (001 GSHA)	■	■	■
	Jet (280)	■	■	■

Pendants

6723 Shell Pendant



Size
16 mm
28 mm

Colour	
Crystal (001)	<input type="checkbox"/>
Crystal AB (001 AB)	<input type="checkbox"/>
Crystal Golden Shadow (001 GSHA)	<input type="checkbox"/>
Crystal Red Magma (001 REDM)	<input type="checkbox"/>
Crystal Silver Shade (001 SSHA)	<input type="checkbox"/>
Jet (280)	<input type="checkbox"/>
Aquamarine (202)	<input type="checkbox"/>
Light Rose (223)	<input type="checkbox"/>

6727 Fish Pendant



Size
18 mm

Colour	
Crystal (001)	<input type="checkbox"/>
Crystal AB (001 AB)	<input type="checkbox"/>
Crystal Copper (001 COP)	<input type="checkbox"/>
Crystal Golden Shadow (001 GSHA)	<input type="checkbox"/>
Crystal Red Magma (001 REDM)	<input type="checkbox"/>
Crystal Silver Shade (001 SSHA)	<input type="checkbox"/>
Jet (280)	<input type="checkbox"/>
Aquamarine (202)	<input type="checkbox"/>
Capri Blue (243)	<input type="checkbox"/>
Indicolite (379)	<input type="checkbox"/>
Light Rose (223)	<input type="checkbox"/>

6735 Leaf Pendant

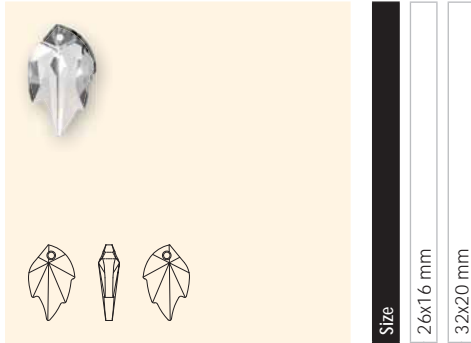

Size
26x16 mm
32x20 mm

Colour	
Crystal (001)	<input type="checkbox"/>
Crystal AB (001 AB)	<input type="checkbox"/>
Crystal Golden Shadow (001 GSHA)	<input type="checkbox"/>
Peridot (214)	<input type="checkbox"/>

Pendants

6744 Flower Pendant

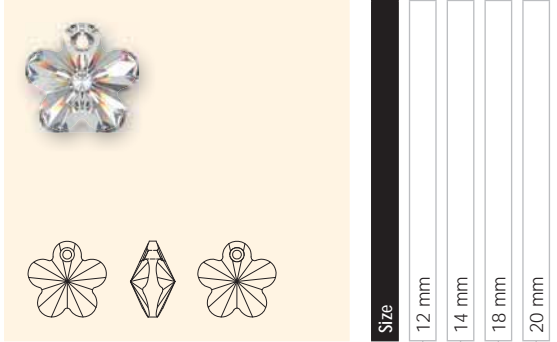

Colour	12 mm	14 mm	18 mm	20 mm
Crystal (001)	■	■	■	■
Crystal AB (001 AB)	■	■	■	■
Crystal Copper (001 COP)	■	■	■	■
Crystal Golden Shadow (001 GSHA)	■	■	■	■
Crystal Silver Shade (001 SSHA)	■	■	■	■
Jet (280)	■	■	■	■
Aquamarine (202)	■	■	■	■
Fuchsia (502)	■	■	■	■
Jonquil (213)	■	■	■	■
Light Rose (223)	■	■	■	■
Light Siam (227)	■	■	■	■
Peridot (214)	■	■	■	■
Violet (371)	■	■	■	■

6754 Butterfly Pendant

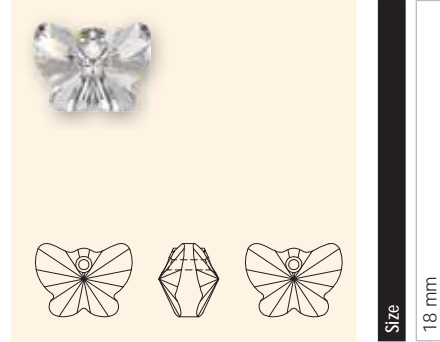

Colour	18 mm
Crystal (001)	■
Crystal Copper (001 COP)	■
Crystal Golden Shadow (001 GSHA)	■
Crystal Moonlight (001 MOL)	■
Crystal Silver Shade (001 SSHA)	■
Jet (280)	■
Amethyst (204)	■
Aquamarine (202)	■
Fuchsia (502)	■
Jonquil (213)	■
Light Rose (223)	■
Peridot (214)	■
Violet (371)	■

6790 Coral Pendant (3 sprigs)

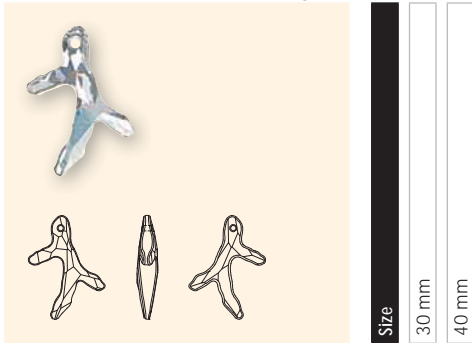

Colour	30 mm	40 mm
Crystal (001)	■	■
Crystal Copper (001 COP)	■	■
Crystal Golden Shadow (001 GSHA)	■	■
Crystal Moonlight (001 MOL)	■	■
Crystal Red Magma (001 REDM)	■	■
Crystal Silver Shade (001 SSHA)	■	■
Jet (280)	■	■
Amethyst (204)	■	■
Aquamarine (202)	■	■
Light Amethyst (212)	■	■
Topaz (203)	■	■

6791 Coral Pendant (2 sprigs)

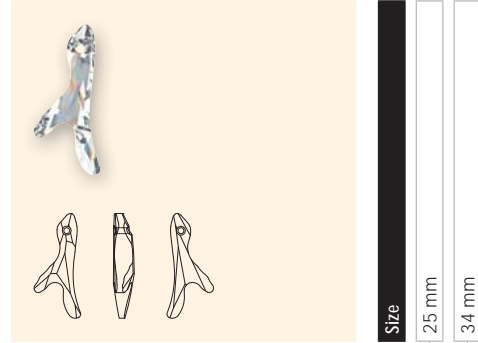

Colour	25 mm	34 mm
Crystal (001)	■	■
Crystal Copper (001 COP)	■	■
Crystal Golden Shadow (001 GSHA)	■	■
Crystal Moonlight (001 MOL)	■	■
Crystal Red Magma (001 REDM)	■	■
Crystal Silver Shade (001 SSHA)	■	■
Jet (280)	■	■
Amethyst (204)	■	■
Aquamarine (202)	■	■
Black Diamond (215)	■	■
Light Amethyst (212)	■	■
Topaz (203)	■	■

Pendants

6860

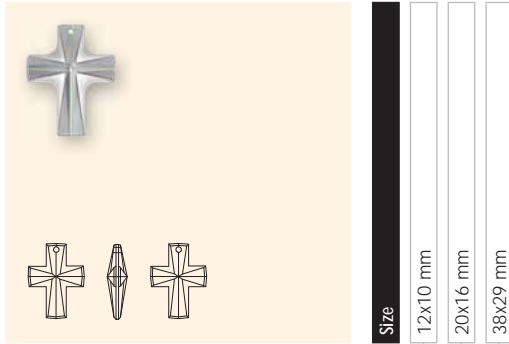

Colour

- Crystal (001)
- Crystal Cosmojet (001 COS)

Size

- 12x10 mm
- 20x16 mm
- 38x29 mm

6864

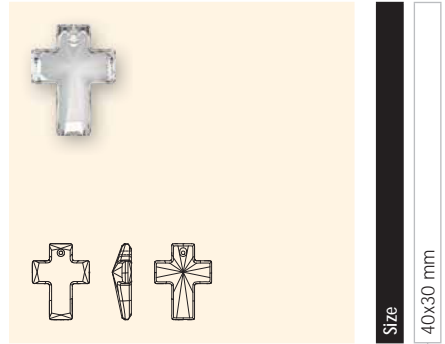

Colour

- Crystal (001)
- Crystal AB V (001 ABV)

Size

- 40x30 mm

6866



Colour

- Crystal (001)
- Crystal AB (001 AB)
- Crystal Golden Shadow (001 GSHA)
- Crystal Heliotrope (001 HEL)
- Crystal Metallic Silver (280 METSI)
- Jet (280)
- Amethyst (204)
- Aquamarine (202)
- Black Diamond (215)
- Light Rose (223)
- Peridot (214)

Size

- 20 mm

6900 Ginko Pendant



Colour

- Crystal (001)
- Crystal Golden Shadow (001 GSHA)
- Crystal Satin (001 SAT)
- Crystal Silver Shade (001 SSHA)
- Jet (280)
- Aquamarine (202)
- Olivine (228)
- Smoked Topaz (220)

Size

- 13.5x20 mm
- 30x45 mm

Pendants

6901 Zinnia Pendant



Size
30x45 mm

- Colour**
- Crystal (001)
 - Crystal Golden Shadow (001 GSHA)
 - Crystal Satin (001 SAT)
 - Crystal Silver Shade (001 SSHA)

6902 Zinnia Pendant

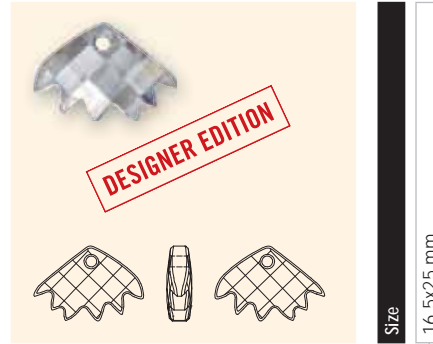

Size
16.5x25 mm

- Colour**
- Crystal (001)
 - Crystal Golden Shadow (001 GSHA)
 - Crystal Satin (001 SAT)
 - Crystal Silver Shade (001 SSHA)
 - Jet (280)
 - Aquamarine (202)
 - Olivine (228)
 - Smoked Topaz (220)

6904 Lily Pendant



Size
30 mm
45 mm

- Colour**
- Crystal (001)
 - Crystal Golden Shadow (001 GSHA)
 - Crystal Satin (001 SAT)
 - Crystal Silver Shade (001 SSHA)
 - Jet (280)
 - Aquamarine (202)
 - Olivine (228)
 - Smoked Topaz (220)

6905 Dragonfly Pendant



Size
30 mm
45 mm

- Colour**
- Crystal (001)
 - Crystal Golden Shadow (001 GSHA)
 - Crystal Satin (001 SAT)
 - Crystal Silver Shade (001 SSHA)
 - Jet (280)
 - Aquamarine (202)
 - Olivine (228)
 - Smoked Topaz (220)

Pendants

6906 Orchid Pendant



Colour		20 mm	40 mm
Crystal (001)	<input type="checkbox"/>	<input type="checkbox"/>	
Crystal Golden Shadow (001 GSHA)	<input type="checkbox"/>	<input type="checkbox"/>	
Crystal Satin (001 SAT)	<input type="checkbox"/>	<input type="checkbox"/>	
Crystal Silver Shade (001 SSHA)	<input type="checkbox"/>	<input type="checkbox"/>	
Jet (280)	<input type="checkbox"/>	<input type="checkbox"/>	
Aquamarine (202)	<input type="checkbox"/>	<input type="checkbox"/>	
Olivine (228)	<input type="checkbox"/>	<input type="checkbox"/>	
Smoked Topaz (220)	<input type="checkbox"/>	<input type="checkbox"/>	

6908 Lotus Pendant



Colour		30 mm	40 mm
Crystal (001)	<input type="checkbox"/>	<input type="checkbox"/>	
Crystal Golden Shadow (001 GSHA)	<input type="checkbox"/>	<input type="checkbox"/>	
Crystal Satin (001 SAT)	<input type="checkbox"/>	<input type="checkbox"/>	
Crystal Silver Shade (001 SSHA)	<input type="checkbox"/>	<input type="checkbox"/>	
Jet (280)	<input type="checkbox"/>	<input type="checkbox"/>	
Aquamarine (202)	<input type="checkbox"/>	<input type="checkbox"/>	
Olivine (228)	<input type="checkbox"/>	<input type="checkbox"/>	
Smoked Topaz (220)	<input type="checkbox"/>	<input type="checkbox"/>	

Pendants

Product Details

<<<

Article Size	Packing Unit = Minimum Order Quantity in Pieces	Average Net Weight in Gram per Packing Unit Crystal (001)	Average Gross Weight in Gram per Packing Unit Crystal (001)
6000			
11x5.5 mm	288	99.8	123.1
13x6.5 mm	288	156.9	197.5
15x7.5 mm	144	129.8	153.4
22x11 mm	48	129.4	151.3
28x14 mm	24	132.2	156.1
6002			
10x7 mm	144	91.4	109.3
15x11.5 mm	72	175.4	197.3
6007			
7x4 mm	360	46.7	55.8
9x5 mm	288	77.1	104.2
6010			
11x5.5 mm	144	57.4	75.9
13x6.5 mm	144	91.1	109.0
17x8.5 mm	36	57.3	77.2
21x10.5 mm	24	66.3	83.4
6012			
11x10 mm	144	94.2	120.0
15.4x14 mm	72	126.0	157.3
6015			
13 mm	144	77.6	102.0
17 mm	72	93.2	111.5
21 mm	48	105.9	129.3
50 mm	6	173.7	222.8
6039			
25 mm	24	88.4	117.5
38 mm	9	92.7	123.8
6049			
20 mm	72	170.5	200.4
30 mm	24	166.7	209.2
6058			
18 mm	24	77.9	97.7
25 mm	24	121.4	171.8
6090			
16x11 mm	72	55.8	75.8
22x15 mm	48	102.2	136.7
6091			
28 mm	40	157.4	198.9
38 mm	24	229.0	263.7
50 mm	6	115.0	144.2
6100			
24x12 mm	36	54.5	83.9
34x20 mm	12	73.0	101.4
6106			
16 mm	144	129.9	158.3
22 mm	96	208.1	248.5
28 mm	36	171.8	201.1
38 mm	9	91.1	121.6
50 mm	6	146.1	177.9

Pendants

Article Size	Packing Unit = Minimum Order Quantity in Pieces	Average Net Weight in Gram per Packing Unit Crystal (001)	Average Gross Weight in Gram per Packing Unit Crystal (001)
6110			
30x14 mm	36	147.6	178.8
40x18 mm	12	132.6	159.2
6150			
30 mm	48	140.6	174.5
50 mm	9	109.2	140.7
6190			
23 mm	30	125.6	159.2
35 mm	18	238.0	269.0
6191			
19 mm	24	64.3	83.1
27 mm	10	72.8	92.1
48 mm	3	113.2	131.7
6210			
12 mm	144	67.8	90.9
17 mm	72	98.8	122.0
6215			
18 mm	72	183.2	210.5
6225			
10 mm	144	48.3	68.4
18 mm	24	41.6	59.0
28 mm	24	160.7	206.2
6228			
10.3x10 mm	288	124.6	152.6
14.4x14 mm	144	181.4	210.5
18x17.5 mm	72	188.0	211.7
28 mm	16	124.0	158.7
40 mm	6	137.9	169.2
6301			
6 mm	360	78.5	89.5
8 mm	288	153.2	173.2
10 mm	144	144.4	165.0
6401			
8 mm	288	106.8	123.8
12 mm	144	164.9	182.7
14 mm	72	108.7	136.7
6428			
6 mm	720	80.1	89.5
8 mm	144	37.4	46.7
12 mm	144	121.8	141.6
6460			
20 mm	72	60.3	83.1
6620			
20 mm	48	88.3	114.6
30 mm	24	126.6	154.8
40 mm	6	81.8	110.5
6621			
18 mm	72	192.8	212.7
28 mm	24	190.8	217.8

Pendants

Article Size	Packing Unit = Minimum Order Quantity in Pieces	Average Net Weight in Gram per Packing Unit Crystal (001)	Average Gross Weight in Gram per Packing Unit Crystal (001)
6650			
22 mm	24	101.5	119.7
6656			
19 mm	48	72.3	94.2
27 mm	30	126.1	159.6
39 mm	6	61.8	82.0
6657			
16x27 mm	30	128.1	157.8
23.5x39 mm	12	149.7	182.6
6670			
18 mm	72	68.4	104.6
24 mm	48	105.5	161.9
50 mm	6	104.7	126.8
6680			
14 mm	144	118.7	145.1
20 mm	72	167.5	191.1
40 mm	12	146.3	171.9
6690			
23 mm	36	54.5	88.6
27 mm	36	99.4	130.5
39 mm	12	95.4	118.7
6704			
20 mm	48	131.4	155.0
25 mm	24	115.8	160.7
30 mm	16	128.1	164.1
35 mm	6	83.6	113.2
6714			
20 mm	48	48.2	73.1
28 mm	24	112.5	156.1
40 mm	6	56.1	87.4
6721			
16 mm	72	105.1	131.7
20 mm	30	76.8	113.6
28 mm	12	66.3	93.7
40 mm	6	83.9	113.5
6722			
16 mm	72	63.9	87.2
20 mm	48	64.3	102.4
30 mm	20	113.8	131.3
6723			
16 mm	96	176.8	215.0
28 mm	18	126.6	160.3
6727			
18 mm	72	168.7	190.1

Pendants

Article Size	Packing Unit = Minimum Order Quantity in Pieces	Average Net Weight in Gram per Packing Unit Crystal (001)	Average Gross Weight in Gram per Packing Unit Crystal (001)
6735			
26x16 mm	30	73.3	110.0
32x20 mm	30	136.7	175.6
6744			
12 mm	144	118.7	145.4
14 mm	144	172.9	204.5
18 mm	72	174.8	207.2
20 mm	48	164.7	193.7
6754			
18 mm	72	217.0	248.3
6790			
30 mm	30	66.5	101.9
40 mm	18	77.5	113.0
6791			
25 mm	48	45.8	84.5
34 mm	24	64.3	92.4
6860			
12x10 mm	144	31.2	54.5
20x16 mm	72	48.2	73.1
38x29 mm	24	99.2	134.8
6864			
40x30 mm	9	109.2	142.2
6866			
20 mm	72	249.5	272.8
6900			
13.5x20 mm	72	138.6	170.8
30x45 mm	6	95.9	123.1
6901			
30x45 mm	6	71.3	89.8
6902			
16.5x25 mm	30	85.4	113.1
6904			
30 mm	36	75.3	80.8
45 mm	6	38.2	65.4
6905			
30 mm	30	67.8	97.5
45 mm	6	41.7	68.3
6906			
20 mm	30	57.8	86.5
40 mm	6	75.3	101.8
6908			
30 mm	18	129.6	159.8
40 mm	6	110.5	135.6

Photography: Christoph Sagel, Robert Striegl
Content is subject to change without notice. Errors and misprints excepted.
SWAROVSKI AG · P.O. Box 567 · 9495 Triesen · Liechtenstein

© 2010 Swarovski AG. All rights reserved. Partial or total publication, transmission, copy or other duplication of texts, graphics, pictures etc. which are to be found in this publication is forbidden without special consent by Swarovski AG.