



## Designer Editions

Swarovski is proud of its long history of creative collaborations with artists, artisans, and designers in all fields of design – a history that continues to be written today by both esteemed established names and new bright young stars. Continually entranced by the myriad possibilities of crystal, these creatives are inspired to transform their sparkling visions into exclusive cuts and designs for Swarovski. Crystal is both the dream-maker and a dynamic source of inspiration for creative minds all over the world.

# Designer Editions

## SUMMARY

### Maison Martin Margiela for Swarovski

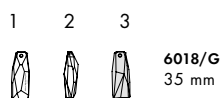
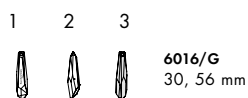

### Collection of Keys inspired by Yoko Ono

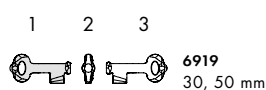
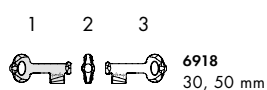

### "Love Story of the Heart" by Manish Arora



### Diamond Leaf

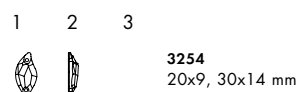
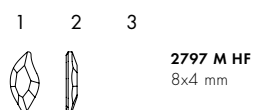
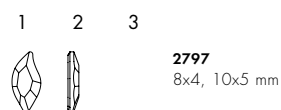

### Divine Rock

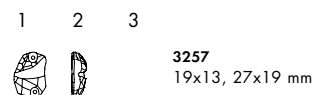

---

## CATALYSING IMAGINATION BY EXCLUSIVE DESIGNER EDITION PRODUCTS

Swarovski can look back with pride on a long history of partnerships with many fashion and design legends like Coco Chanel or Christian Dior. The Aurora Borealis effect, for example, found worldwide acclaim following work with Christian Dior in the 1950s. More recently, the creative partnership with Giorgio Armani saw the development of the Diamond Leaf cut, which features an organic design and closely resembles a natural leaf. Manish Arora created a special collection of heart-shaped crystal pendants for Swarovski. In 2012 a memorable key-shaped crystal pendant was designed for Swarovski, inspired by Yoko Ono. In the last cooperation the “Crystalactite” was developed together with renowned Parisian design house Maison Martin Margiela. This innovative precision-cut crystal component draws its inspiration directly from nature, with “Crystalactite” reflecting the origin of iconic stalactite shapes. These design co-operations are joyful collaborations that always result in beauty and quite unconventional displays of creativity.

Dior, Maison Martin Margiela and Yoko Ono are just three examples of the many celebrated designers/artists who have worked with Swarovski over the years, turning loose crystals into limitless creative possibilities.

---

## DESIGNER EDITIONS – DISTINCT PACKAGING

All products except Maison Martin Margiela Designer Edition will be labelled with the “Designer Edition” imprint directly on the packaging. The Maison Martin Margiela Designer Edition will be labelled with the “Maison Martin Margiela for Swarovski” imprint.

MAISON MARTIN MARGIELA FOR SWAROVSKI

Crystalactite Pendants

Since 1988, Paris-based Maison Martin Margiela has become famous for its collaborative team-led approach and its avant-garde transformation of classic designs. In July 2013, it presented the *Maison Martin Margiela Crystalactite for Swarovski* at its Paris Haute Couture show. These were groundbreaking Crystal Fusion components inspired by natural stalactite forms and developed in creative partnership with Swarovski. Now Swarovski presents its interpretation of this innovative cut in pure crystal – the *Crystalactite Pendant*. Featuring a progressive aesthetic combining partly frosted facets with primeval, irregular icicle shapes, the vision that originated in our wildest landscapes has now been perfected by one of the most sophisticated design houses. Together with an easy-to-apply hole at the top, the Grand and Petite Pendants offer myriad design possibilities for strong, contemporary designs, and for recreating haute-couture looks.

“Naturally and spontaneously, an imposing crystal emerges from its raw, stony origin, patiently growing into its iconic stalactite shape.”

6016/G The Grand Crystalactite partly frosted



<b>Crystal</b>		
Crystal (001)	<input type="checkbox"/>	<input type="checkbox"/>
<b>Colors</b>		
<b>Plain Colors</b>		
Jet (280)	<input type="checkbox"/>	<input type="checkbox"/>
<b>Crystal Effects</b>		
<b>Transparent Effects</b>		
Crystal AB V (001 AB V)	<input type="checkbox"/>	<input type="checkbox"/>
Crystal Antique Pink V (001 ANTP V)	<input type="checkbox"/>	<input type="checkbox"/>
Crystal Bermuda Blue P (001 BBL)*	<input type="checkbox"/>	<input type="checkbox"/>
Crystal Blue Shade V (001 BLSH V)	<input type="checkbox"/>	<input type="checkbox"/>
Crystal Bronze Shade V (001 BRSH V)	<input type="checkbox"/>	<input type="checkbox"/>
Crystal Copper V (001 COP V)	<input type="checkbox"/>	<input type="checkbox"/>
Crystal Golden Shadow V (001 GSHA V)	<input type="checkbox"/>	<input type="checkbox"/>
Crystal Silver Night (001 SINI)	<input type="checkbox"/>	<input type="checkbox"/>
Crystal Silver Shade V (001 SSHA V)	<input type="checkbox"/>	<input type="checkbox"/>
Crystal Vitrail Light P (001 VL)*	<input type="checkbox"/>	<input type="checkbox"/>
Crystal Vitrail Medium P (001 VM)*	<input type="checkbox"/>	<input type="checkbox"/>
<b>Metallic Effects</b>		
Crystal Comet Argent Light V P (001 CAL V)*	<input type="checkbox"/>	<input type="checkbox"/>

6017/G Crystalactite Pendant grand partly frosted



<b>Crystal</b>		
Crystal (001)	<input type="checkbox"/>	<input type="checkbox"/>
<b>Colors</b>		
<b>Plain Colors</b>		
Jet (280)	<input type="checkbox"/>	<input type="checkbox"/>
<b>Crystal Effects</b>		
<b>Transparent Effects</b>		
Crystal AB V (001 AB V)	<input type="checkbox"/>	<input type="checkbox"/>
Crystal Antique Pink V (001 ANTP V)	<input type="checkbox"/>	<input type="checkbox"/>
Crystal Bermuda Blue P (001 BBL)*	<input type="checkbox"/>	<input type="checkbox"/>
Crystal Blue Shade V (001 BLSH V)	<input type="checkbox"/>	<input type="checkbox"/>
Crystal Bronze Shade V (001 BRSH V)	<input type="checkbox"/>	<input type="checkbox"/>
Crystal Copper V (001 COP V)	<input type="checkbox"/>	<input type="checkbox"/>
Crystal Golden Shadow V (001 GSHA V)	<input type="checkbox"/>	<input type="checkbox"/>
Crystal Silver Night (001 SINI)	<input type="checkbox"/>	<input type="checkbox"/>
Crystal Silver Shade V (001 SSHA V)	<input type="checkbox"/>	<input type="checkbox"/>
Crystal Vitrail Light P (001 VL)*	<input type="checkbox"/>	<input type="checkbox"/>
Crystal Vitrail Medium P (001 VM)*	<input type="checkbox"/>	<input type="checkbox"/>
<b>Metallic Effects</b>		
Crystal Comet Argent Light V P (001 CAL V)*	<input type="checkbox"/>	<input type="checkbox"/>

\* For details about the “protective layer” please refer to page 24.

6018/G The Petite Crystalactite partly frosted



- Crystal**
- Crystal (001)
- Colors**
- Plain Colors**
- Jet (280)
- Crystal Effects**
- Transparent Effects**
- Crystal AB V (001 AB V)
- Crystal Antique Pink V (001 ANTP V)
- Crystal Bermuda Blue P (001 BBL)\*
- Crystal Blue Shade V (001 BLSH V)
- Crystal Bronze Shade V (001 BRSH V)
- Crystal Copper V (001 COP V)
- Crystal Golden Shadow V (001 GSHA V)
- Crystal Silver Night (001 SINI)
- Crystal Silver Shade V (001 SSHA V)
- Crystal Vitrail Light P (001 VL)\*
- Crystal Vitrail Medium P (001 VM)\*
- Metallic Effects**
- Crystal Comet Argent Light V P (001 CAL V)\*

6019/G Crystalactite Pendant petite partly frosted



- Crystal**
- Crystal (001)
- Colors**
- Plain Colors**
- Jet (280)
- Crystal Effects**
- Transparent Effects**
- Crystal AB V (001 AB V)
- Crystal Antique Pink V (001 ANTP V)
- Crystal Bermuda Blue P (001 BBL)\*
- Crystal Blue Shade V (001 BLSH V)
- Crystal Bronze Shade V (001 BRSH V)
- Crystal Copper V (001 COP V)
- Crystal Golden Shadow V (001 GSHA V)
- Crystal Silver Night (001 SINI)
- Crystal Silver Shade V (001 SSHA V)
- Crystal Vitrail Light P (001 VL)\*
- Crystal Vitrail Medium P (001 VM)\*
- Metallic Effects**
- Crystal Comet Argent Light V P (001 CAL V)\*

\* For details about the "protective layer" please refer to page 24.

---

**YOKO ONO**

Yoko Ono is a multi-media artist whose thought provoking work challenges people's understanding of art and the world around them.

Her work as a conceptualist has encompassed performance, instructions, film, music, writing, and now jewelry inspiration for Swarovski.

Born in Tokyo in 1933, she moved to New York in 1953, where she became part of the city's vibrant avant-garde scene. She went on to perform and exhibit what have now become legendary works in the history of contemporary art, including her famous 1969 collaboration, *Bed-In*, with husband John Lennon.

She has had numerous exhibitions in museums, and in 2009, received the Golden Lion for Lifetime Achievement from the Venice Biennale. In 2011 Ono was honored with the prestigious 8th Hiroshima Art Prize for her dedicated peace activism, and in 2012 received the Oskar Kokoschka Prize in Vienna.

---

**THE COOPERATION**

A memorable key-shaped crystal pendant, inspired by Yoko Ono, has been designed for Swarovski. The design itself is a technical masterwork and tells us a wonderful story around the symbol key. It is available in two different versions: with and without the signature of Yoko Ono.

---

**THE STORY**

**"Imagine a key that unlocks the door to the forest with its secrets,  
to the sky with its peacefulness,  
to the universe with its infinity,  
to a future with the promise of a better life."**

**Yoko Ono**

This concept by Yoko Ono has been created as a crystal "KEY TO OPEN THE FOREST" exclusively for our Swarovski collection. It embodies the spirits of earth and sky, and reflects the multiple colors of nature. "Make a promise to a tree. Ask it to be passed on to other trees." When you wear it you will be sharing Yoko's dream of peaceful interaction with the world around you. "Whisper your dream to a cloud. Ask the cloud to remember it." A memorable key-shaped crystal pendant, inspired by Yoko Ono, has been designed for Swarovski. The design itself is a technical masterwork and tells us a wonderful story around the symbol key. It is available in two different versions: with and without the signature of Yoko Ono.

6918 Key to Open the Forest\*



- Crystal**
- Crystal (001)
- Colors**
- Plain Colors**
- Indian Sapphire (217)
- Crystal Effects**
- Transparent Effects**
- Crystal Blue Shade (001 BLSH)
- Crystal Bronze Shade (001 BRSH)
- Crystal Copper (001 COP)
- Crystal Golden Shadow (001 GSHA)
- Crystal Silver Night (001 SINI)
- Crystal Silver Shade (001 SSHA)

6919 Key Pendant

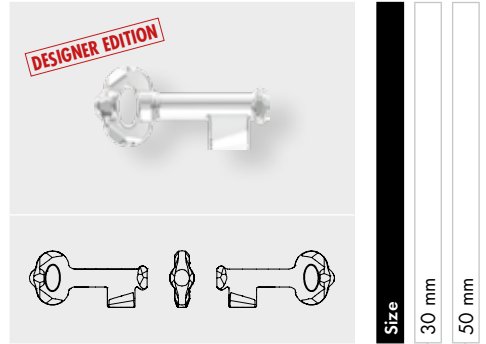

- Crystal**
- Crystal (001)
- Colors**
- Plain Colors**
- Indian Sapphire (217)
- Crystal Effects**
- Transparent Effects**
- Crystal AB (001 AB)
- Crystal Blue Shade (001 BLSH)
- Crystal Bronze Shade (001 BRSH)
- Crystal Copper (001 COP)
- Crystal Golden Shadow (001 GSHA)
- Crystal Silver Night (001 SINI)
- Crystal Silver Shade (001 SSHA)
- Metallic Effects**
- Crystal Iridescent Green (001 IRIG)

\* Please note, that this article is only available until August 2015.



“LOVE STORY OF THE HEART” BY MANISH ARORA

Since the beginning of his international career, the award winning, Delhi-based designer Manish Arora has worked creatively with Swarovski. In 2009, he created a memorable collection of crystalline Transfers. One year later, India’s best loved and most prolific design talent renewed his partnership with Swarovski and created a special collection of heart-shaped crystal pendants, which were launched in February 2011. Each individual piece is an expression of love’s different emotional state and is named accordingly.

The partnership with Manish Arora is symbolic of how Swarovski engages in mutually rewarding creative partnerships with the world’s best and brightest design spirits.

“The heart shape is very close to me because it is the universal symbol of love. I wanted to bring this symbol to life by creating a collection of crystal pendants and I hope people will wear them as a personal expression of the beauty and purity of this emotion,” Manish Arora

6260 Crazy 4 U Heart

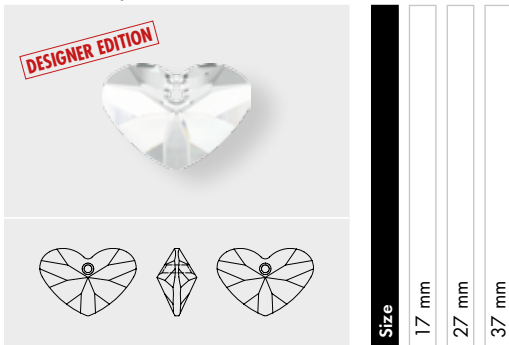

- Crystal**
- Crystal (001)
- Crystal Effects**
- Transparent Effects**
- Crystal AB (001 AB)
- Crystal Antique Pink (001 ANTP)
- Crystal Astral Pink (001 API)
- Crystal Golden Shadow (001 GSHA)
- Crystal Satin (001 SAT)

6261 Devoted 2 U Heart

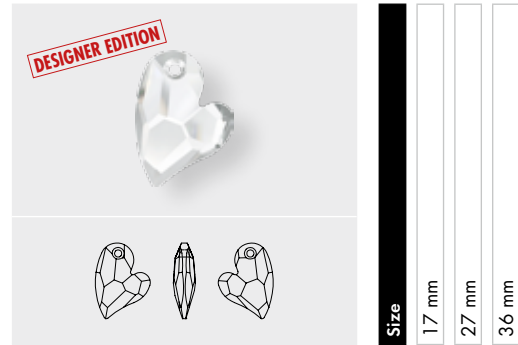

- Crystal**
- Crystal (001)
- Colors**
- Plain Colors**
- Amethyst (204)
- Aquamarine (202)
- Jet (280)
- Rosaline (508)
- Crystal Effects**
- Transparent Effects**
- Crystal AB (001 AB)
- Crystal Antique Pink (001 ANTP)
- Crystal Astral Pink (001 API)
- Crystal Bermuda Blue P (001 BBL)\*
- Crystal Blue Shade (001 BLSH)
- Crystal Golden Shadow (001 GSHA)
- Crystal Lilac Shadow (001 LISH)
- Crystal Red Magma (001 REDM)
- Crystal Satin (001 SAT)
- Crystal Vitrail Medium P (001 VM)\*
- Metallic Effects**
- Crystal Comet Argent Light V P (001 CAL V)\*

\* For details about the “protective layer” please refer to page 24.

6262 Miss U Heart

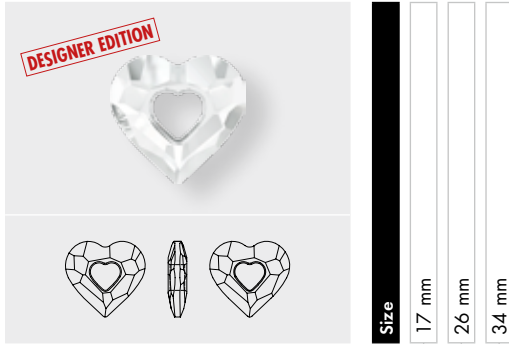

Crystal	17 mm	26 mm	34 mm
Crystal (001)	■	■	■
<b>Colors</b>			
<b>Plain Colors</b>			
Amethyst (204)	■		
<b>Crystal Effects</b>			
<b>Transparent Effects</b>			
Crystal AB (001 AB)	■	■	■
Crystal Antique Pink (001 ANTP)	■	■	■
Crystal Astral Pink (001 API)	■	■	■
Crystal Golden Shadow (001 GSHA)	■	■	■
Crystal Lilac Shadow (001 LISH)	■	■	■
Crystal Satin (001 SAT)	■	■	■

6264 Truly in Love Heart

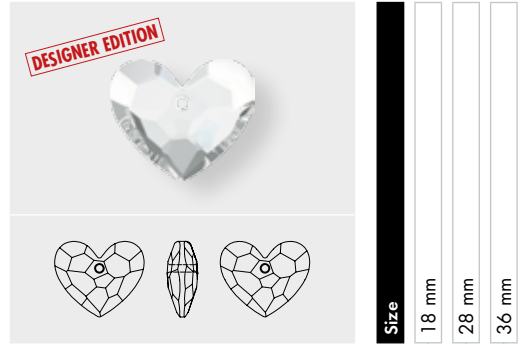

Crystal	18 mm	28 mm	36 mm
Crystal (001)	■	■	■
<b>Crystal Effects</b>			
<b>Transparent Effects</b>			
Crystal AB (001 AB)	■	■	■
Crystal Antique Pink (001 ANTP)	■	■	■
Crystal Astral Pink (001 API)	■	■	■
Crystal Bermuda Blue P (001 BBL)*	■	■	■
Crystal Golden Shadow (001 GSHA)	■	■	■
Crystal Lilac Shadow (001 LISH)	■	■	■
Crystal Red Magma (001 REDM)	■	■	■
Crystal Satin (001 SAT)	■	■	■

\* For details about the “protective layer” please refer to page 24.

**DIAMOND LEAF**

Swarovski and Giorgio Armani worked together to create an exclusive crystal called "Diamond Leaf". This Designer Edition has a fluid, organic shape reminiscent of a leaf. Precision cut facets melt into the softness of a floating, sculptural form, contrasting strength and fragility, the timeless with the ethereal.

**Giorgio Armani:** "Swarovski crystal brings a touch of magic to a dress, an ethereal quality, a lustre which never fails to captivate the attention."

**2797 Diamond Leaf Flat Back No Hotfix**



**Size**  
8x4 mm  
10x5 mm

**Crystal**  
Crystal F (001)

**Crystal Effect**

**Transparent Effects**  
Crystal AB F (001 AB)

**2797 Diamond Leaf Flat Back Hotfix**



**Size**  
8x4 mm

**Crystal**  
Crystal M HF (001)

**Crystal Effect**

**Transparent Effects**  
Crystal AB M HF (001 AB)

**3254 Diamond Leaf Sew-on Stone**



**Size**  
20x9 mm  
30x14 mm

**Crystal**  
Crystal F (001)

**Colors**  
Plain Colors  
Jet (280)

**Crystal Effects**  
Transparent Effects  
Crystal Golden Shadow F (001 GSHA)  
Crystal Silver Shade F (001 SSAH)

**DIVINE ROCK**

This exclusive cut is the result of Swarovski’s creative cooperation with leading international designers that present a quite unique look. The crystal features an exciting contrast between sparkling facets and other facets with a matt finish. An optimal brilliance and superb light refraction is achieved thanks to the use of an irregular and deep layered cutting technology, which is yet another example of the innovative power invested in producing cutting edge Swarovski.

**3257 Divine Rock Sew-on Stone**

**DESIGNER EDITION**

**Crystal**

Crystal F (001)

**Size**

19x13 mm

27x19 mm

## Designer Editions

## PRODUCT DETAILS

Article Size	Packing Unit = Minimum Order Quantity in Pieces	Average Net Weight in Gram per Packing Unit Crystal (001)	Average Gross Weight in Gram per Packing Unit Crystal (001)
<b>2797</b>			
8x4 mm	240	14.9	24.0
10x15 mm	180	23.4	32.6
<b>2797 M HF</b>			
8x4 mm	240	14.9	24.0
<b>3254</b>			
20x9 mm	72	60.3	87.8
30x14 mm	36	100.6	129.6
<b>3257</b>			
19x13 mm	96	58.3	76.3
27x19 mm	30	132.2	152.0
<b>6016/G</b>			
30 mm	12	20.160	45.612
56 mm	6	67.536	91.392
<b>6017/G</b>			
30 mm	12	24.968	45.612
56 mm	6	67.536	91.392
<b>6018/G</b>			
35 mm	8	52.416	74.592
<b>6019/G</b>			
35 mm	8	52.416	74.592
<b>6260</b>			
17 mm	48	56.25	81.93
27 mm	20	88.72	111.92
37 mm	6	60.26	88.96
<b>6261</b>			
17 mm	48	48.21	76.63
27 mm	20	77.00	102.60
36 mm	12	112.49	135.29
<b>6262</b>			
17 mm	48	67.90	91.90
26 mm	16	74.02	92.48
34 mm	6	53.74	80.33
<b>6918</b>			
30 mm	36	63.806	88.633
50 mm	6	43.596	66.493
<b>6919</b>			
30 mm	36	63.806	88.633
50 mm	6	43.596	66.493

