



## Fancy Stones & Settings

Fancy Stones are offered in numerous shapes ranging from classical gemstone-inspired cuts to progressive trend cuts. They come in a huge assortment of different sizes and colors. Showing either a faceted or flat reverse side, Fancy Stones can be glued into pre-cast cavities or used in metal settings. Their precision-cut facets ensure the highest brilliance and endow design ideas with a unique sparkle.

Settings are unplated or plated brass components, each specifically tailored to a Fancy Stone, that secure the crystal and allow for a myriad of application possibilities, including but not limited to sewing, soldering, and gluing.

# Fancy Stones & Settings

## SUMMARY

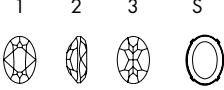
1 2 3 S  

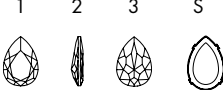
**4120**  
 6x4, 8x6, 14x10,  
 18x13, 25x18 mm

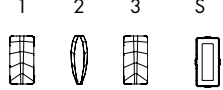
1 2 3 S  

**4327**  
 30x20, 40x27 mm

1 2 3 S  

**4524**  
 12x6, 16x8,  
 23x11 mm

1 2 3 S  

**4127**  
 30x22, 39x28 mm

1 2 3 S  

**4328**  
 6x3.6, 8x4.8,  
 10x6, 13x7.8 mm

1 2 3 S  

**4527**  
 8x6, 14x10,  
 18x13 mm

1 2 3 S  

**4128**  
 6x4, 8x6, 10x8,  
 14x10 mm

1 2 3 S  

**4370**  
 11x10, 15.5x14,  
 20x18 mm

1 2 3 S  

**4547**  
 15x5, 21x7, 24x8,  
 30x10 mm

1 2 3 S  

**4137**  
 15x11, 22x16,  
 33x24 mm

1 2 3 S  

**4418**  
 6, 8 mm

1 2 3 S  

**4565**  
 14x10, 18x13 mm

1 2 3 S  

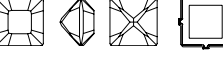
**4139**  
 14, 20, 30 mm

1 2 3 S  

**4428**  
 1.5, 2, 3, 4, 5,  
 6, 8 mm

1 2 3 S  

**4568**  
 8x6, 14x10,  
 18x13, 27x18 mm

1 2 3 S  

**4161**  
 15x5, 21x7,  
 27x9 mm

1 2 3 S  

**4439**  
 14, 20, 30 mm

1 2 3 S  

**4600**  
 6x4, 8x6, 10x8,  
 12x10 mm

1 2 3 S  

**4196**  
 23x20, 30x26 mm

1 2 3 S  

**4447**  
 6, 8, 10, 12 mm

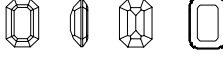
1 2 3 S  

**4610**  
 14x10, 18x13,  
 20x15 mm

1 2 3 S  

**4200**  
 11x3, 15x4,  
 35x9.5, 48x13 mm

1 2 3 S  

**4461**  
 8, 12, 16 mm

1 2 3 S  

**4627**  
 27x18.5,  
 37x25.5 mm

1 2 3 S  

**4224**  
 10x8, 14x11,  
 23x18 mm

1 2 3 S  

**4470**  
 10, 12, 18 mm

1 2 3 S  

**4675**  
 23 mm

1 2 3 S  

**4227**  
 32x17 mm

1 2 3 S  

**4500**  
 3x2, 6x2, 10x3 mm

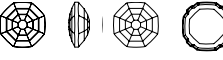
1 2 3 S  

**4678**  
 8, 14, 23 mm

1 2 3 S  

**4228**  
 4x2, 5x2.5, 6x3,  
 8x4, 10x5, 15x7  
 mm

1 2 3 S  

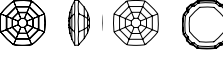
**4501**  
 4x2, 5x2, 5x2.5,  
 7x3, 10x5 mm

1 2 3 S  

**4678/G**  
 8, 14, 23 mm

1 2 3 S  

**4230**  
 14x9, 19x12,  
 23x15 mm

1 2 3 S  

**4502**  
 3x1 mm

1 2 3 S  

**4706**  
 7, 12, 17, 24 mm

1 2 3 S  

**4320**  
 6x4, 8x6, 10x7,  
 14x10, 18x13 mm

1 2 3 S  

**4505**  
 8x5, 10x6, 14x8  
 mm

1 2 3 S  

**4717**  
 15.5, 21.5 mm

— ... Setting available

# Fancy Stones & Settings

|   |   |   |   |                                       |   |   |   |   |  |
|---|---|---|---|---------------------------------------|---|---|---|---|--|
| 1 | 2 | 3 | S | 4722<br>4, 6, 8, 10 mm                | 1 | 2 | 3 | S | 4795<br>14, 19, 28 mm                                |
|   |   |   |   |                                       |   |   |   |   |  |
|   |   |   |   | 4727<br>23 mm                         |   |   |   |   | 4809<br>13x12, 17x15.5,<br>27x25 mm                  |
|   |   |   |   | 4739<br>14x11, 20x16 mm               |   |   |   |   | 4810<br>13x12 mm                                     |
|   |   |   |   | 4744<br>6, 10 mm                      |   |   |   |   | 4827<br>28 mm  |
|   |   |   |   | 4745<br>5, 10 mm                      |   |   |   |   | 4831<br>5.5x5, 8.8x8,<br>11x10 mm                    |
|   |   |   |   | 4747<br>5 mm                          |   |   |   |   | 4835<br>3.5 mm                                       |
|   |   |   |   | 4748<br>5, 10 mm                      |   |   |   |   | 4841<br>4, 6, 8 mm                                   |
|   |   |   |   | 4756<br>19x11.5, 27x16,<br>39x23.5 mm |   |   |   |   | 4869<br>4, 6, 8, 10 mm                               |
|   |   |   |   | 4757<br>14x8.5,<br>19x11.5 mm         |   |   |   |   | 4884<br>5.5x5, 6.6x6,<br>8.8x8, 11x10,<br>15.4x14 mm |
|   |   |   |   | 4760<br>14x8, 18x10.5,<br>22x12.5 mm  |   |   |   |   |  |
|   |   |   |   | 4773<br>14x7.5, 18x9.5,<br>28x15 mm   |   |   |   |   |  |
|   |   |   |   | 4789<br>14, 23, 29 mm                 |   |   |   |   |  |
|   |   |   |   | 4790<br>18x7.5, 23x10,<br>32x13.5 mm  |   |   |   |   |  |

– ... Setting available

1 Top view 2 Side view 3 Back view S Setting

# Fancy Stones & Settings

## ARTICLE EXPLANATION & ORDERING EXAMPLE FOR SETTINGS

### 4120/S

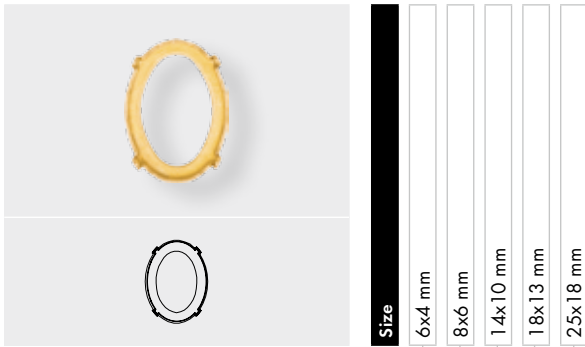

#### Ring/Hole, Back Configuration

|                                  |   |   |   |   |   |
|----------------------------------|---|---|---|---|---|
| 00 C = No ring/hole, closed      | ■ | ■ | ■ | ■ | ■ |
| H2 O = 4 holes/2 each side, open | ■ | ■ | ■ | ■ | ■ |

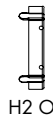
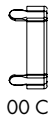

| 4120/S           | 6x4 mm                              | 1             | P                    | H2                       | O                  | Z                                     |
|------------------|-------------------------------------|---------------|----------------------|--------------------------|--------------------|---------------------------------------|
| Base item number | Stone Size                          | Material type | type                 | Hole configuration       | Back configuration | Plating                               |
|                  | Same digit code as for Fancy Stones | 1 Brass       | P Non-gluing element | 00 No Hole<br>H2 2 Holes | C Closed<br>O Open | Z No Plating<br>3 Gold*<br>H Rhodium* |

\* Anti nickel allergenic. Only available with the 2 hole (H2O) version.

# Fancy Stones & Settings

4120

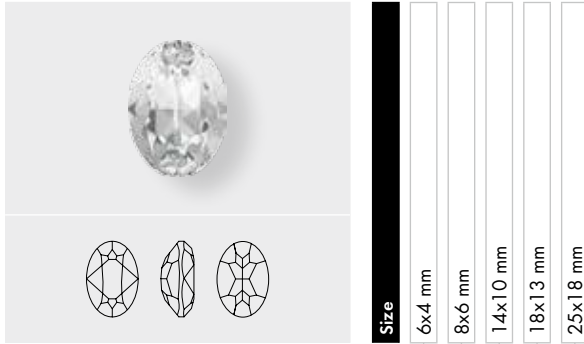

| Crystal                    | 6x4 mm | 8x6 mm | 14x10 mm | 18x13 mm | 25x18 mm |
|----------------------------|--------|--------|----------|----------|----------|
| Crystal (001)              | ■      | ■      | ■        | ■        | ■        |
| Crystal F (001)            | ■      | ■      | ■        | ■        | ■        |
| Colors                     |        |        |          |          |          |
| Plain Colors               |        |        |          |          |          |
| Amethyst F (204)           | ■      | ■      | ■        | ■        | ■        |
| Aquamarine F (202)         | ■      | ■      | ■        | ■        | ■        |
| Black Diamond F (215)      | ■      | ■      | ■        | ■        | ■        |
| Chrysolite F (238)         | ■      | ■      | ■        | ■        | ■        |
| Dark Moss Green F (260)    | ■      | ■      | ■        | ■        | ■        |
| Emerald F (205)            | ■      | ■      | ■        | ■        | ■        |
| Erinite F (360)            | ■      | ■      | ■        | ■        | ■        |
| Fuchsia F (502)            | ■      | ■      | ■        | ■        | ■        |
| Greige F (284)             | ■      | ■      | ■        | ■        | ■        |
| Indian Sapphire F (217)    | ■      | ■      | ■        | ■        | ■        |
| Indicolite F (379)         | ■      | ■      | ■        | ■        | ■        |
| Jet (280)                  | ■      | ■      | ■        | ■        | ■        |
| Light Amethyst F (212)     | ■      | ■      | ■        | ■        | ■        |
| Light Azure F (361)        | ■      | ■      | ■        | ■        | ■        |
| Light Peach F (362)        | ■      | ■      | ■        | ■        | ■        |
| Light Rose F (223)         | ■      | ■      | ■        | ■        | ■        |
| Light Silk F (261)         | ■      | ■      | ■        | ■        | ■        |
| Light Smoked Topaz F (221) | ■      | ■      | ■        | ■        | ■        |
| Light Turquoise F (263)    | ■      | ■      | ■        | ■        | ■        |
| Montana F (207)            | ■      | ■      | ■        | ■        | ■        |
| Padparadscha F (542)       | ■      | ■      | ■        | ■        | ■        |
| Peridot F (214)            | ■      | ■      | ■        | ■        | ■        |
| Provence Lavender F (283)  | ■      | ■      | ■        | ■        | ■        |
| Rosaline F (508)           | ■      | ■      | ■        | ■        | ■        |
| Rose F (209)               | ■      | ■      | ■        | ■        | ■        |
| Rose Peach F (262)         | ■      | ■      | ■        | ■        | ■        |
| Sapphire F (206)           | ■      | ■      | ■        | ■        | ■        |
| Siam F (208)               | ■      | ■      | ■        | ■        | ■        |
| Tanzanite F (539)          | ■      | ■      | ■        | ■        | ■        |
| Topaz F (203)              | ■      | ■      | ■        | ■        | ■        |
| Vintage Rose F (319)       | ■      | ■      | ■        | ■        | ■        |
| Violet F (371)             | ■      | ■      | ■        | ■        | ■        |
| Opal Colors                |        |        |          |          |          |
| Pacific Opal F (390)       | ■      | ■      | ■        | ■        | ■        |
| Rose Water Opal F (395)    | ■      | ■      | ■        | ■        | ■        |
| White Opal F (234)         | ■      | ■      | ■        | ■        | ■        |

4120

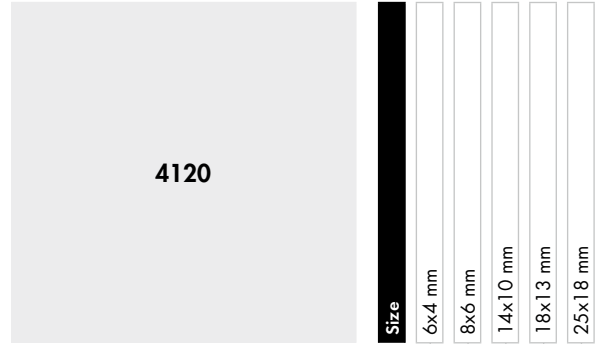

| Crystal Effects                       | 6x4 mm | 8x6 mm | 14x10 mm | 18x13 mm | 25x18 mm |
|---------------------------------------|--------|--------|----------|----------|----------|
| Transparent Effects                   |        |        |          |          |          |
| Crystal Antique Pink (001 ANTP)       | ■      | ■      | ■        | ■        | ■        |
| Crystal Antique Pink F (001 ANTP)     | ■      | ■      | ■        | ■        | ■        |
| Crystal Astral Pink F (001 API)       | ■      | ■      | ■        | ■        | ■        |
| Crystal Blue Shade F (001 BLSH)       | ■      | ■      | ■        | ■        | ■        |
| Crystal Golden Shadow (001 GSHA)      | ■      | ■      | ■        | ■        | ■        |
| Crystal Golden Shadow F (001 GSHA)    | ■      | ■      | ■        | ■        | ■        |
| Crystal Lilac Shadow F (001 LISH)     | ■      | ■      | ■        | ■        | ■        |
| Crystal Silver Night F (001 SINI)     | ■      | ■      | ■        | ■        | ■        |
| Crystal Silver Shade F (001 SSHA)     | ■      | ■      | ■        | ■        | ■        |
| Metallic Effects                      |        |        |          |          |          |
| Crystal Iridescent Green F (001 IRIG) | ■      | ■      | ■        | ■        | ■        |
| Crystal Rose Gold F (001 ROGL)        | ■      | ■      | ■        | ■        | ■        |
| Crystal Patina                        |        |        |          |          |          |
| Crystal Black Patina F (001 BLAPA)    | ■      | ■      | ■        | ■        | ■        |
| Crystal Gold Patina F (001 GOLPA)     | ■      | ■      | ■        | ■        | ■        |
| Crystal Rose Patina F (001 ROSPA)     | ■      | ■      | ■        | ■        | ■        |
| Crystal Silver Patina F (001 SILPA)   | ■      | ■      | ■        | ■        | ■        |
| Crystal White Patina F (001 WHIPA)    | ■      | ■      | ■        | ■        | ■        |

4120/S

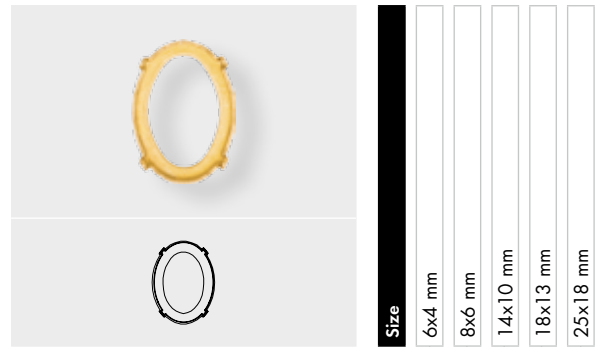

| Ring/Hole, Back Configuration    | 6x4 mm | 8x6 mm | 14x10 mm | 18x13 mm | 25x18 mm |
|----------------------------------|--------|--------|----------|----------|----------|
| 00 C = No ring/hole, closed      | ■      | ■      | ■        | ■        | ■        |
| H2 O = 4 holes/2 each side, open | ■      | ■      | ■        | ■        | ■        |

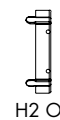

# Fancy Stones & Settings

4127

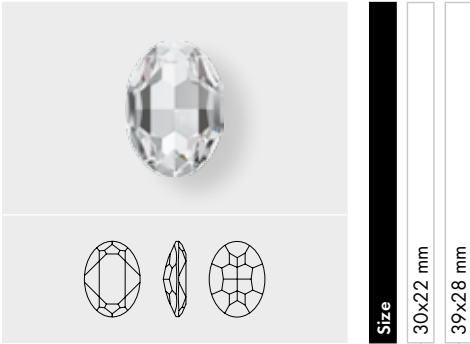

Size

30x22 mm

39x28 mm

**Crystal**

Crystal F (001)

**Colors**

**Plain Colors**

- Amethyst F (204)
- Aquamarine F (202)
- Black Diamond F (215)
- Burgundy F (515)
- Chrysolite F (238)
- Dark Moss Green F (260)
- Jet (280)
- Light Colorado Topaz F (246)
- Light Rose F (223)
- Light Turquoise F (263)
- Montana F (207)
- Rosaline F (508)
- Tanzanite F (539)

**Opal Colors**

White Opal F (234)

**Crystal Effects**

**Transparent Effects**

- Crystal AB F (001 AB)
- Crystal Antique Pink F (001 ANTP)
- Crystal Astral Pink F (001 API)
- Crystal Blue Shade F (001 BLSH)
- Crystal Golden Shadow F (001 GSHA)
- Crystal Lilac Shadow F (001 LISH)
- Crystal Luminous Green F (001 LUMG)
- Crystal Red Magma F (001 REDM)
- Crystal Silver Shade F (001 SSHA)
- Crystal Vitrail Medium (001 VM)

**Metallic Effects**

Crystal Iridescent Green F (001 IRIG)

**Crystal Patina**

- Crystal Black Patina F (001 BLAPA)
- Crystal Gold Patina F (001 GOLPA)
- Crystal Rose Patina F (001 ROSPA)
- Crystal Silver Patina F (001 SILPA)
- Crystal White Patina F (001 WHIPA)

4127/S

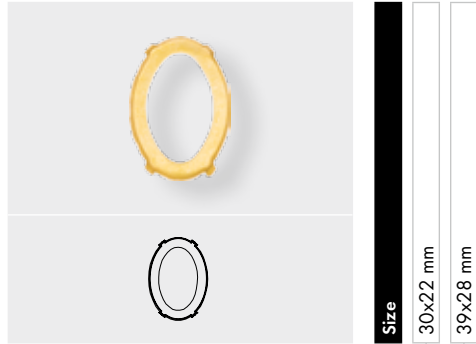

Size

30x22 mm

39x28 mm

**Ring/Hole, Back Configuration**

00 C = No ring/hole, closed

H2 O = 4 holes/2 each side, open

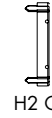

00 C

H2 O

# Fancy Stones & Settings

## 4128 XILION Oval Fancy Stone

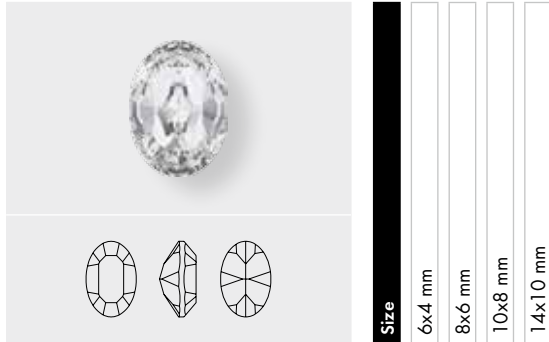

| Crystal                             | 6x4 mm | 8x6 mm | 10x8 mm | 14x10 mm |
|-------------------------------------|--------|--------|---------|----------|
| Crystal F (001)                     | ■      | ■      | ■       | ■        |
| Colors                              |        |        |         |          |
| Plain Colors                        |        |        |         |          |
| Amethyst F (204)                    | ■      | ■      | ■       | ■        |
| Aquamarine F (202)                  | ■      | ■      | ■       | ■        |
| Black Diamond F (215)               | ■      | ■      | ■       | ■        |
| Denim Blue F (266)                  | ■      | ■      | ■       | ■        |
| Emerald F (205)                     | ■      | ■      | ■       | ■        |
| Light Amethyst F (212)              | ■      | ■      | ■       | ■        |
| Light Rose F (223)                  | ■      | ■      | ■       | ■        |
| Montana F (207)                     | ■      | ■      | ■       | ■        |
| Rose F (209)                        | ■      | ■      | ■       | ■        |
| Siam F (208)                        | ■      | ■      | ■       | ■        |
| Topaz F (203)                       | ■      | ■      | ■       | ■        |
| Crystal Effects                     |        |        |         |          |
| Transparent Effects                 |        |        |         |          |
| Crystal Golden Shadow F (001 GSHA)  | ■      | ■      | ■       | ■        |
| Crystal Luminous Green F (001 LUMG) | ■      | ■      | ■       | ■        |
| Crystal Red Magma F (001 REDM)      | ■      | ■      | ■       | ■        |

## 4128/S



| Ring/Hole, Back Configuration    | 6x4 mm | 8x6 mm | 10x8 mm | 14x10 mm |
|----------------------------------|--------|--------|---------|----------|
| 00 C = No ring/hole, closed      | ■      | ■      | ■       | ■        |
| H2 O = 4 holes/2 each side, open | ■      | ■      | ■       | ■        |

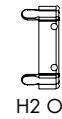
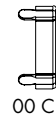



# Fancy Stones & Settings

## 4137 Cosmic Oval Fancy Stone



| Size | 15x11 mm | 22x16 mm | 33x24 mm |
|------|----------|----------|----------|
|------|----------|----------|----------|

- Crystal**
- Crystal (001)
- Crystal CAL V SI (001 CAL V SI)
- Colors**
- Plain Colors**
- Jet (280)
- Crystal Effects**
- Transparent Effects**
- Crystal Golden Shadow (001 GSHA)

## 4139 Cosmic Ring Fancy Stone

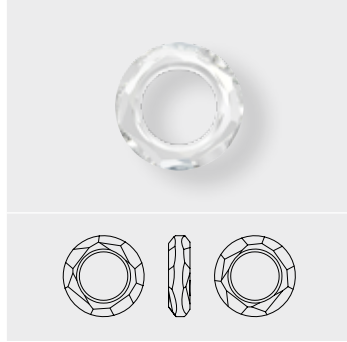

| Size | 14 mm | 20 mm | 30 mm |
|------|-------|-------|-------|
|------|-------|-------|-------|

- Crystal**
- Crystal (001)
- Crystal CAL V SI (001 CAL V SI)
- Colors**
- Plain Colors**
- Jet (280)
- Crystal Effects**
- Transparent Effects**
- Crystal AB (001 AB)
- Crystal Antique Pink (001 ANTP)
- Crystal Astral Pink (001 API)
- Crystal Bermuda Blue (001 BBL)
- Crystal Blue Shade (001 BLSH)
- Crystal Golden Shadow (001 GSHA)
- Crystal Lilac Shadow (001 LISH)
- Crystal Luminous Green (001 LUMG)
- Crystal Silver Night (001 SINI)
- Crystal Silver Shade (001 SSHA)
- Crystal Silver Shade CAL V SI (001 SSHA CAL V SI)
- Crystal Vitrail Light (001 VL)
- Crystal Volcano (001 VOL)

# Fancy Stones & Settings

## 4161 Long Classical Oval Fancy Stone

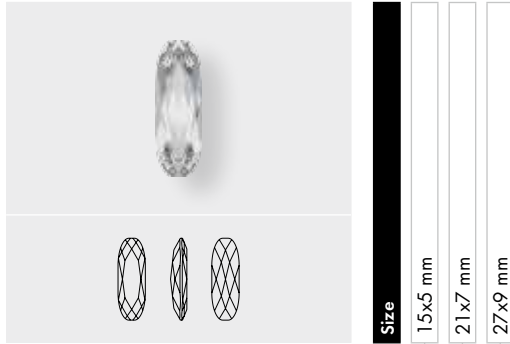

### Crystal

Crystal F (001)

### Colors

#### Plain Colors

Amethyst F (204)

Aquamarine F (202)

Indicolite F (379)

Light Colorado Topaz F (246)

Light Rose F (223)

Light Turquoise F (263)

Olivine F (228)

Padparadscha F (542)

### Crystal Effects

#### Transparent Effects

Crystal Astral Pink F (001 API)

## 4161/S

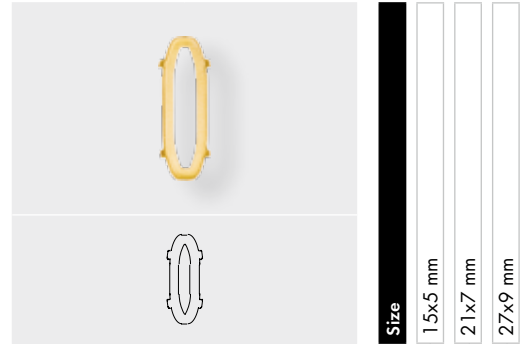

### Ring/Hole, Back Configuration

00 C = No ring/hole, closed

H2 O = 4 holes/2 each side, open

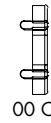

00 C

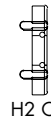

H2 O

## 4196 Nautilus Fancy Stone

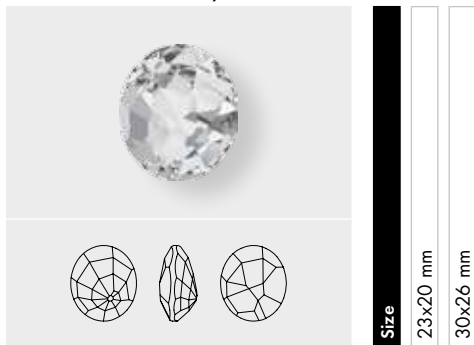

### Crystal

Crystal F (001)

### Colors

#### Plain Colors

Black Diamond F (215)

Light Amethyst F (212)

Light Azure F (361)

Light Colorado Topaz F (246)

Montana F (207)

Silk F (391)

## 4196/S

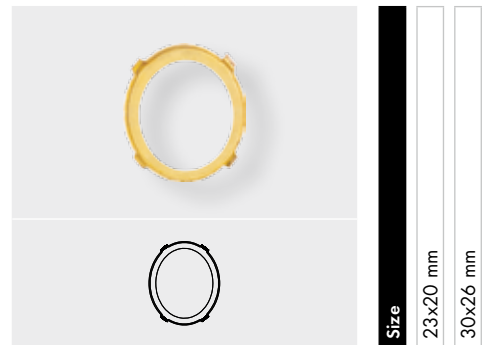

### Ring/Hole, Back Configuration

00 C = No ring/hole, closed

H2 O = 4 holes/2 each side, open



00 C



H2 O

# Fancy Stones & Settings

## 4200 Sphinx Eye Fancy Stone

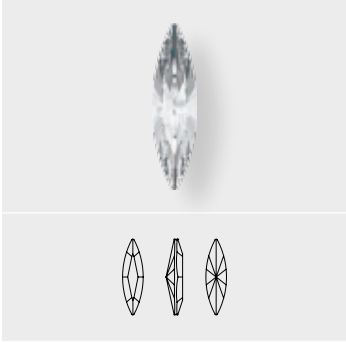

| Size | 11x3 mm | 15x4 mm | 35x9.5 mm | 48x13 mm |
|------|---------|---------|-----------|----------|
|------|---------|---------|-----------|----------|

| Crystal                            | 11x3 mm | 15x4 mm | 35x9.5 mm | 48x13 mm |
|------------------------------------|---------|---------|-----------|----------|
| Crystal F (001)                    | ■       | ■       | ■         | ■        |
| Colors                             |         |         |           |          |
| Plain Colors                       |         |         |           |          |
| Denim Blue F (266)                 |         |         | ■         | ■        |
| Jet (280)                          | ■       | ■       | ■         | ■        |
| Crystal Effects                    |         |         |           |          |
| Transparent Effects                |         |         |           |          |
| Crystal Golden Shadow F (001_GSHA) | ■       | ■       | ■         | ■        |
| Crystal Silver Shade F (001_SSHA)  |         |         | ■         | ■        |
| Color Effect                       |         |         |           |          |
| Metallic Effects                   |         |         |           |          |
| Jet Hematite (280_HEM)             |         |         | ■         | ■        |

## 4200/S

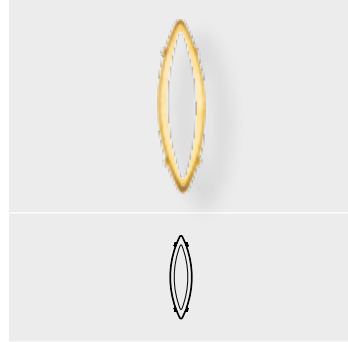

| Size | 11x3 mm | 15x4 mm | 35x9.5 mm | 48x13 mm |
|------|---------|---------|-----------|----------|
|------|---------|---------|-----------|----------|

| Ring/Hole, Back Configuration    | 11x3 mm | 15x4 mm | 35x9.5 mm | 48x13 mm |
|----------------------------------|---------|---------|-----------|----------|
| 00 C = No ring/hole, closed      | ■       | ■       | ■         | ■        |
| H2 O = 4 holes/2 each side, open | ■       | ■       | ■         | ■        |



# Fancy Stones & Settings

4224 Pure Leaf Fancy Stone

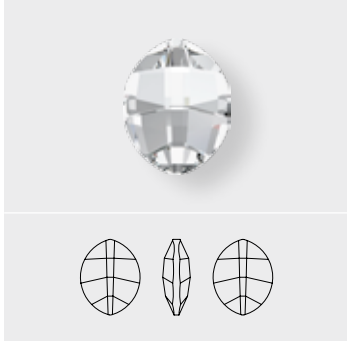

Size 10x8, 14x11 mm

4224 Pure Leaf Fancy Stone

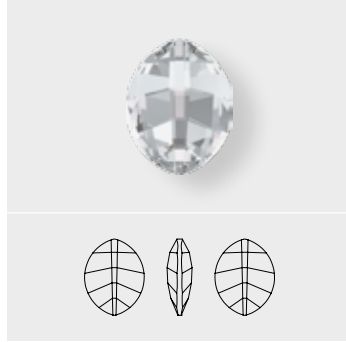

Size 23x18 mm

**4224**

|                                     | Size 10x8 mm | Size 14x11 mm | Size 23x18 mm |
|-------------------------------------|--------------|---------------|---------------|
| <b>Crystal</b>                      |              |               |               |
| Crystal F (001)                     | ■            | ■             | ■             |
| <b>Colors</b>                       |              |               |               |
| <b>Plain Colors</b>                 |              |               |               |
| Amethyst F (204)                    | ■            | ■             | ■             |
| Dark Moss Green F (260)             | ■            | ■             | ■             |
| Emerald F (205)                     | ■            | ■             | ■             |
| Peridot F (214)                     | ■            | ■             | ■             |
| Jet (280)                           | ■            | ■             | ■             |
| <b>Opal Colors</b>                  |              |               |               |
| White Opal F (234)                  | ■            | ■             | ■             |
| <b>Crystal Effects</b>              |              |               |               |
| <b>Transparent Effects</b>          |              |               |               |
| Crystal AB F (001 AB)               | ■            | ■             | ■             |
| Crystal Blue Shade F (001 BLSH)     | ■            | ■             | ■             |
| Crystal Golden Shadow F (001 GSHA)  | ■            | ■             | ■             |
| Crystal Luminous Green F (001 LUMG) | ■            | ■             | ■             |
| Crystal Red Magma F (001 REDM)      | ■            | ■             | ■             |
| Crystal Silver Night (001 SINI)     | ■            | ■             | ■             |
| <b>Crystal Patina</b>               |              |               |               |
| Crystal Black Patina F (001 BLAPA)  | ■            | ■             | ■             |
| Crystal Gold Patina F (001 GOLPA)   | ■            | ■             | ■             |
| Crystal Rose Patina F (001 ROSPA)   | ■            | ■             | ■             |
| Crystal Silver Patina F (001 SILPA) | ■            | ■             | ■             |
| Crystal White Patina F (001 WHIPA)  | ■            | ■             | ■             |

4224/S

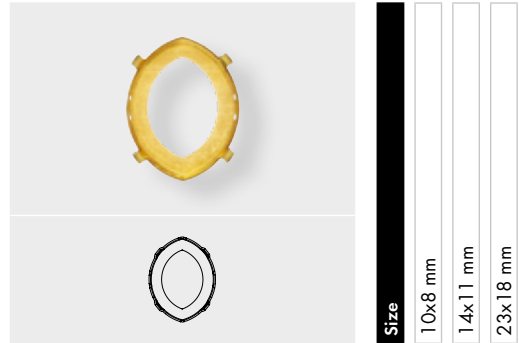

**Ring/Hole, Back Configuration**

00 C = No ring/hole, closed

H2 O = 4 holes/2 each side, open

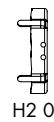
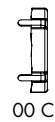

00 C

H2 O

# Fancy Stones & Settings

4227

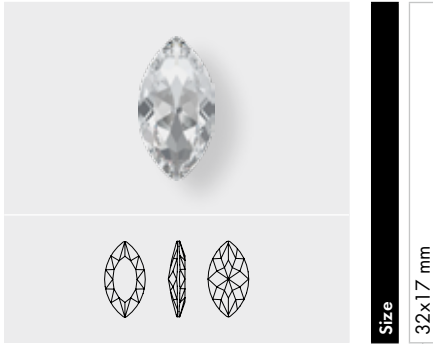

Size

32x17 mm

**Crystal**

Crystal F (001)

**Colors**

**Plain Colors**

Jet (280)

**Crystal Effects**

**Transparent Effects**

Crystal AB F (001 AB)

Crystal Golden Shadow F (001 GSHA)

Crystal Silver Shade F (001 SSHA)

4227/S

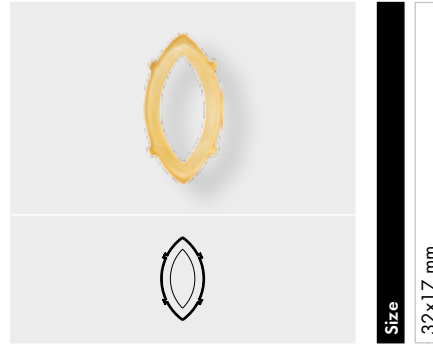

Size

32x17 mm

**Ring/Hole, Back Configuration**

00 C = No ring/hole, closed

H2 O = 4 holes/2 each side, open

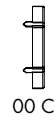

00 C

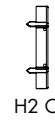

H2 O

# Fancy Stones & Settings

4228



Size 4x2, 5x2.5 mm

4228 XILLION Navette Fancy Stone



Size 6x3, 8x4, 10x5, 15x7 mm



**Crystal**

Crystal F (001)

**Colors**

**Plain Colors**

Amethyst F (204)

Aquamarine F (202)

Black Diamond F (215)

Dark Moss Green F (260)

Denim Blue F (266)

Emerald F (205)

Fuchsia F (502)

Greige F (284)

Indian Siam F (327)

Indicolite F (379)

Jet (280)

Jonquil F (213)

Light Amethyst F (212)

Light Colorado Topaz F (246)

Light Rose F (223)

Light Sapphire F (211)

Light Siam F (227)

Light Silk F (261)

Light Turquoise F (263)

Montana F (207)

Padparadscha F (542)

Peridot F (214)

Provence Lavender F (283)

Purple Velvet F (277)

Rosaline F (508)

Rose F (209)

Rose Peach F (262)

Sapphire F (206)

Siam F (208)

Smoked Topaz F (220)

Tangerine F (259)

Tanzanite F (539)

Topaz F (203)

**Opal Colors**

Chrysolite Opal F (294)

Pacific Opal F (390)

White Opal F (234)

Size

4x2 mm

5x2.5 mm

6x3 mm

8x4 mm

10x5 mm

15x7 mm

# Fancy Stones & Settings

| 4228                       |                                       | Size | 4x2 mm | 5x2.5 mm | 6x3 mm | 8x4 mm | 10x5 mm | 15x7 mm |
|----------------------------|---------------------------------------|------|--------|----------|--------|--------|---------|---------|
| <b>Crystal Effects</b>     |                                       |      |        |          |        |        |         |         |
| <b>Transparent Effects</b> |                                       |      |        |          |        |        |         |         |
|                            | Crystal AB F (001 AB)                 |      |        |          |        |        |         |         |
|                            | Crystal Antique Pink F (001 ANTP)     |      |        |          |        |        |         |         |
|                            | Crystal Astral Pink F (001 API)       |      |        |          |        |        |         |         |
|                            | Crystal Blue Shade F (001 BLSH)       |      |        |          |        |        |         |         |
|                            | Crystal Golden Shadow F (001 GSHA)    |      |        |          |        |        |         |         |
|                            | Crystal Lilac Shadow F (001 LISH)     |      |        |          |        |        |         |         |
|                            | Crystal Luminous Green F (001 LUMG)   |      |        |          |        |        |         |         |
|                            | Crystal Red Magma F (001 REDM)        |      |        |          |        |        |         |         |
|                            | Crystal Silver Night F (001 SINI)     |      |        |          |        |        |         |         |
|                            | Crystal Silver Shade F (001 SSHA)     |      |        |          |        |        |         |         |
| <b>Metallic Effects</b>    |                                       |      |        |          |        |        |         |         |
|                            | Crystal Iridescent Green F (001 IRIG) |      |        |          |        |        |         |         |
|                            | Crystal Rose Gold F (001 ROGL)        |      |        |          |        |        |         |         |
| <b>Color Effects</b>       |                                       |      |        |          |        |        |         |         |
| <b>Metallic Effects</b>    |                                       |      |        |          |        |        |         |         |
|                            | Jet Hematite (280 HEM)                |      |        |          |        |        |         |         |

## 4228/S

| 4228/S                               |      | Size | 5x2.5 mm | 6x3 mm | 8x4 mm | 10x5 mm | 15x7 mm |
|--------------------------------------|------|------|----------|--------|--------|---------|---------|
| <b>Ring/Hole, Back Configuration</b> |      |      |          |        |        |         |         |
| 00 C = No ring/hole, closed          |      |      |          |        |        |         |         |
| H2 O = 4 holes/2 each side, open     |      |      |          |        |        |         |         |
|                                      | 00 C |      |          |        |        |         |         |
|                                      | H2 O |      |          |        |        |         |         |

# Fancy Stones & Settings

## 4230 Lemon Fancy Stone

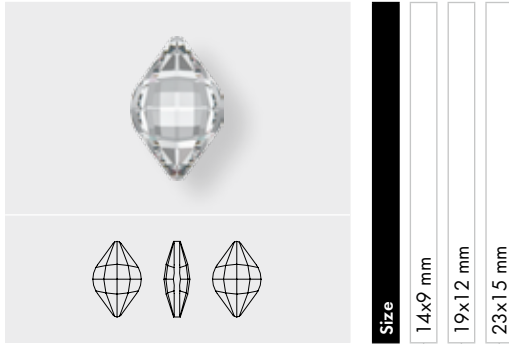

**Size**  
 14x9 mm  
 19x12 mm  
 23x15 mm

| Crystal                            | 14x9 mm                  | 19x12 mm                 | 23x15 mm                 |
|------------------------------------|--------------------------|--------------------------|--------------------------|
| Crystal F (001)                    | <input type="checkbox"/> | <input type="checkbox"/> | <input type="checkbox"/> |
| Colors                             |                          |                          |                          |
| Plain Colors                       |                          |                          |                          |
| Amethyst F (204)                   | <input type="checkbox"/> | <input type="checkbox"/> | <input type="checkbox"/> |
| Aquamarine F (202)                 | <input type="checkbox"/> | <input type="checkbox"/> | <input type="checkbox"/> |
| Dark Moss Green F (260)            | <input type="checkbox"/> | <input type="checkbox"/> | <input type="checkbox"/> |
| Erinite F (360)                    | <input type="checkbox"/> | <input type="checkbox"/> | <input type="checkbox"/> |
| Light Siam F (227)                 | <input type="checkbox"/> | <input type="checkbox"/> | <input type="checkbox"/> |
| Light Silk F (261)                 | <input type="checkbox"/> | <input type="checkbox"/> | <input type="checkbox"/> |
| Light Smoked Topaz F (221)         | <input type="checkbox"/> | <input type="checkbox"/> | <input type="checkbox"/> |
| Light Topaz F (226)                | <input type="checkbox"/> | <input type="checkbox"/> | <input type="checkbox"/> |
| Rosaline F (508)                   | <input type="checkbox"/> | <input type="checkbox"/> | <input type="checkbox"/> |
| Opal Colors                        |                          |                          |                          |
| White Opal F (234)                 | <input type="checkbox"/> | <input type="checkbox"/> | <input type="checkbox"/> |
| Crystal Effects                    |                          |                          |                          |
| Transparent Effects                |                          |                          |                          |
| Crystal Antique Pink F (001 ANTP)  | <input type="checkbox"/> | <input type="checkbox"/> | <input type="checkbox"/> |
| Crystal Blue Shade F (001 BLSH)    | <input type="checkbox"/> | <input type="checkbox"/> | <input type="checkbox"/> |
| Crystal Golden Shadow F (001 GSHA) | <input type="checkbox"/> | <input type="checkbox"/> | <input type="checkbox"/> |
| Crystal Silver Night F (001 SINI)  | <input type="checkbox"/> | <input type="checkbox"/> | <input type="checkbox"/> |

## 4230/S



**Size**  
 14x9 mm  
 19x12 mm  
 23x15 mm

| Ring/Hole, Back Configuration    | 14x9 mm                  | 19x12 mm                 | 23x15 mm                 |
|----------------------------------|--------------------------|--------------------------|--------------------------|
| 00 C = No ring/hole, closed      | <input type="checkbox"/> | <input type="checkbox"/> | <input type="checkbox"/> |
| H2 O = 4 holes/2 each side, open | <input type="checkbox"/> | <input type="checkbox"/> | <input type="checkbox"/> |





# Fancy Stones & Settings

4320

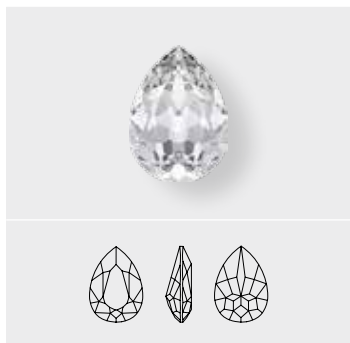

| Size | 6x4 mm | 8x6 mm | 10x7 mm | 14x10 mm | 18x13 mm |
|------|--------|--------|---------|----------|----------|
|------|--------|--------|---------|----------|----------|

**Crystal**

- Crystal (001)
- Crystal F (001)

**Colors**

**Plain Colors**

- Amethyst F (204)
- Aquamarine F (202)
- Black Diamond F (215)
- Dark Moss Green F (260)
- Denim Blue F (266)
- Emerald F (205)
- Fern Green F (291)
- Greige F (284)
- Jet (280)
- Light Colorado Topaz F (246)
- Light Silk F (261)
- Light Turquoise F (263)
- Montana F (207)
- Olivine F (228)
- Padparadscha F (542)
- Provence Lavender F (283)
- Rosaline F (508)
- Rose F (209)
- Rose Peach F (262)
- Siam F (208)
- Tangerine F (259)
- Tanzanite F (539)
- Vintage Rose F (319)

**Opal Colors**

- Caribbean Blue Opal F (394)
- Chrysolite Opal F (294)
- Pacific Opal F (390)
- Rose Water Opal F (395)
- White Opal F (234)

**Crystal Effects**

**Transparent Effects**

- Crystal AB F (001 AB)
- Crystal Antique Pink F (001 ANTP)
- Crystal Astral Pink F (001 API)
- Crystal Blue Shade F (001 BLSH)
- Crystal Golden Shadow F (001 GSHA)

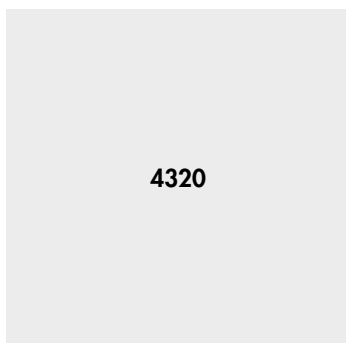

| Size | 6x4 mm | 8x6 mm | 10x7 mm | 14x10 mm | 18x13 mm |
|------|--------|--------|---------|----------|----------|
|------|--------|--------|---------|----------|----------|

- Crystal Lilac Shadow F (001 LISH)
- Crystal Luminous Green F (001 LUMG)
- Crystal Moonlight F (001 MOL)
- Crystal Red Magma F (001 REDM)
- Crystal Silver Night F (001 SINI)
- Crystal Silver Shade F (001 SSHA)
- Metallic Effects**
- Crystal Iridescent Green F (001 IRIG)
- Crystal Metallic Light Gold F (001 MLGLD)
- Crystal Rose Gold F (001 ROGL)
- Crystal Patina**
- Crystal Black Patina F (001 BLAPA)
- Crystal Gold Patina F (001 GOLPA)
- Crystal Rose Patina F (001 ROSPA)
- Crystal Silver Patina F (001 SILPA)
- Crystal White Patina F (001 WHIPA)

4320/S



| Size | 6x4 mm | 8x6 mm | 10x7 mm | 14x10 mm | 18x13 mm |
|------|--------|--------|---------|----------|----------|
|------|--------|--------|---------|----------|----------|

**Ring/Hole, Back Configuration**

- 00 C = No ring/hole, closed
- H2 O = 4 holes/2 each side, open



# Fancy Stones & Settings

4327

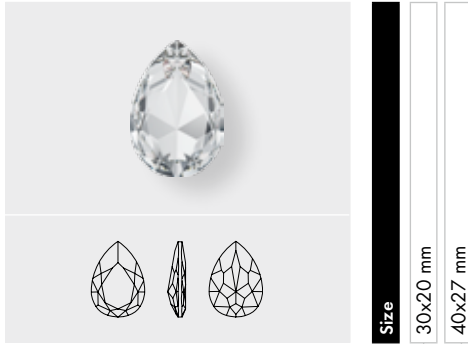

Size  
30x20 mm  
40x27 mm

**Crystal**

Crystal F (001)

**Colors**

**Plain Colors**

- Amethyst F (204)
- Aquamarine F (202)
- Black Diamond F (215)
- Chrysolite F (238)
- Dark Moss Green F (260)
- Fuchsia F (502)
- Jet (280)
- Light Colorado Topaz F (246)
- Light Rose F (223)
- Montana F (207)
- Rosaline F (508)
- Tanzanite F (539)

**Opal Colors**

White Opal F (234)

**Crystal Effects**

**Transparent Effects**

- Crystal AB F (001 AB)
- Crystal Antique Pink F (001 ANTP)
- Crystal Astral Pink F (001 API)
- Crystal Golden Shadow F (001 GSHA)
- Crystal Lilac Shadow F (001 LISH)
- Crystal Luminous Green F (001 LUMG)
- Crystal Red Magma F (001 REDM)
- Crystal Silver Shade F (001 SSHA)
- Crystal Vitrail Medium (001 VM)

**Metallic Effects**

Crystal Iridescent Green F (001 IRIG)

**Crystal Patina**

- Crystal Black Patina F (001 BLAPA)
- Crystal Gold Patina F (001 GOLPA)
- Crystal Rose Patina F (001 ROSPA)
- Crystal Silver Patina F (001 SILPA)
- Crystal White Patina F (001 WHIPA)

4327/S

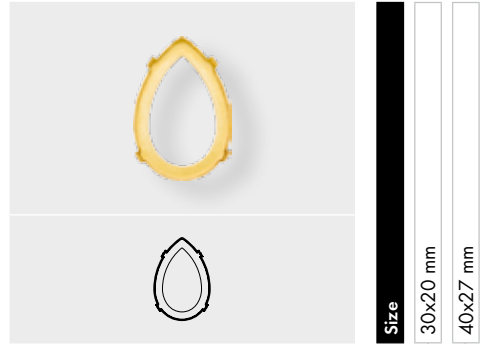

Size  
30x20 mm  
40x27 mm

**Ring/Hole, Back Configuration**

00 C = No ring/hole, closed

H2 O = 4 holes/2 each side, open

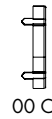

00 C

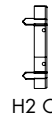

H2 O

# Fancy Stones & Settings

## 4328 XILION Pear Fancy Stone



| Size | 6x3.6 mm | 8x4.8 mm | 10x6 mm | 13x7.8 mm |
|------|----------|----------|---------|-----------|
|------|----------|----------|---------|-----------|

- Crystal**
- Crystal F (001)
- Colors**
- Plain Colors**
- Amethyst F (204)
- Aquamarine F (202)
- Black Diamond F (215)
- Emerald F (205)
- Jet (280)
- Light Amethyst F (212)
- Light Colorado Topaz F (246)
- Light Rose F (223)
- Montana F (207)
- Rose F (209)
- Siam F (208)
- Tanzanite F (539)
- Crystal Effects**
- Transparent Effects**
- Crystal Golden Shadow F (001 GSHA)
- Crystal Luminous Green F (001 LUMG)

## 4328/S



| Size | 6x3.6 mm | 8x4.8 mm | 10x6 mm | 13x7.8 mm |
|------|----------|----------|---------|-----------|
|------|----------|----------|---------|-----------|

- Ring/Hole, Back Configuration**
- 00 C = No ring/hole, closed
- H2 O = 4 holes/2 each side, open



## 4370

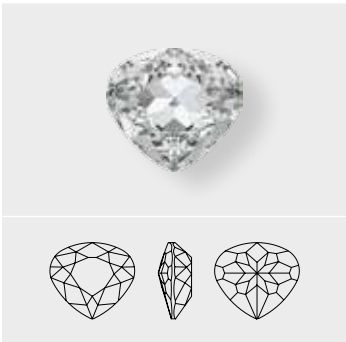

| Size | 11x10 mm | 15.5x14 mm | 20x18 mm |
|------|----------|------------|----------|
|------|----------|------------|----------|

- Crystal**
- Crystal F (001)
- Colors**
- Plain Colors**
- Tanzanite (539)
- Crystal Effects**
- Transparent Effects**
- Crystal Golden Shadow (001 GSHA)

## 4370/S



| Size | 11x10 mm | 15.5x14 mm | 20x18 mm |
|------|----------|------------|----------|
|------|----------|------------|----------|

- Ring/Hole, Back Configuration**
- 00 C = No ring/hole, closed
- H2 O = 4 holes/2 each side, open



# Fancy Stones & Settings

## 4418 XILION Pointed Square Fancy Stone

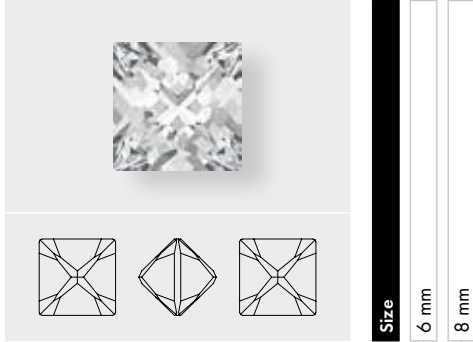

|                                     | 6 mm                     | 8 mm                     |
|-------------------------------------|--------------------------|--------------------------|
| <b>Crystal</b>                      |                          |                          |
| Crystal (001)                       | <input type="checkbox"/> | <input type="checkbox"/> |
| Crystal F (001)                     | <input type="checkbox"/> | <input type="checkbox"/> |
| <b>Colors</b>                       |                          |                          |
| <b>Plain Colors</b>                 |                          |                          |
| Aquamarine F (202)                  | <input type="checkbox"/> | <input type="checkbox"/> |
| Black Diamond F (215)               | <input type="checkbox"/> | <input type="checkbox"/> |
| Dark Moss Green F (260)             | <input type="checkbox"/> | <input type="checkbox"/> |
| Jet (280)                           | <input type="checkbox"/> | <input type="checkbox"/> |
| Light Rose F (223)                  | <input type="checkbox"/> | <input type="checkbox"/> |
| Montana F (207)                     | <input type="checkbox"/> | <input type="checkbox"/> |
| Tanzanite F (539)                   | <input type="checkbox"/> | <input type="checkbox"/> |
| <b>Crystal Effects</b>              |                          |                          |
| <b>Transparent Effects</b>          |                          |                          |
| Crystal AB F (001 AB)               | <input type="checkbox"/> | <input type="checkbox"/> |
| Crystal Golden Shadow F (001 GSHA)  | <input type="checkbox"/> | <input type="checkbox"/> |
| Crystal Lilac Shadow F (001 LISH)   | <input type="checkbox"/> | <input type="checkbox"/> |
| Crystal Luminous Green F (001 LUMG) | <input type="checkbox"/> | <input type="checkbox"/> |
| Crystal Silver Shade F (001 SSHA)   | <input type="checkbox"/> | <input type="checkbox"/> |
| <b>Metallic Effects</b>             |                          |                          |
| Crystal Rose Gold F (001 ROGL)      | <input type="checkbox"/> | <input type="checkbox"/> |
| <b>Crystal Patina</b>               |                          |                          |
| Crystal Black Patina F (001 BLAPA)  | <input type="checkbox"/> | <input type="checkbox"/> |
| Crystal Gold Patina F (001 GOLPA)   | <input type="checkbox"/> | <input type="checkbox"/> |
| Crystal Rose Patina F (001 ROSPA)   | <input type="checkbox"/> | <input type="checkbox"/> |
| Crystal Silver Patina F (001 SILPA) | <input type="checkbox"/> | <input type="checkbox"/> |
| Crystal White Patina F (001 WHIPA)  | <input type="checkbox"/> | <input type="checkbox"/> |

## 4418/S

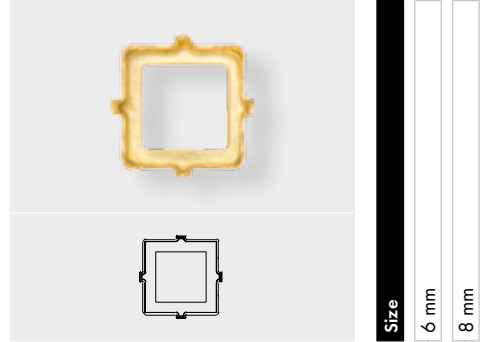

|                                      | 6 mm                     | 8 mm                     |
|--------------------------------------|--------------------------|--------------------------|
| <b>Ring/Hole, Back Configuration</b> |                          |                          |
| 00 C = No ring/hole, closed          | <input type="checkbox"/> | <input type="checkbox"/> |
| H2 O = 4 holes/2 each side, open     | <input type="checkbox"/> | <input type="checkbox"/> |



00 C



H2 O

# Fancy Stones & Settings

4428

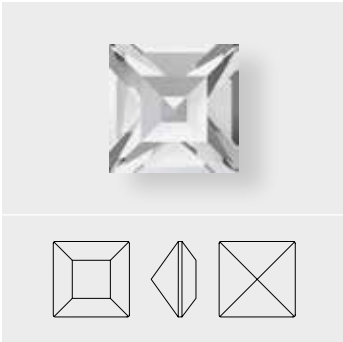

Size 1.5, 2 mm

4428 XILION Square Fancy Stone

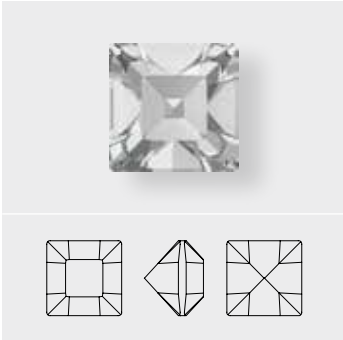

Size 3, 4 mm

4428 XILION Square Fancy Stone

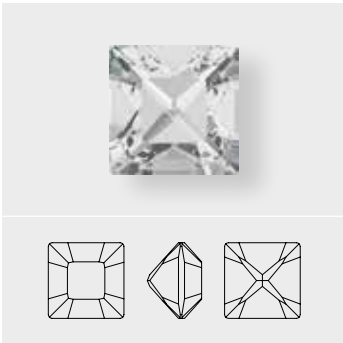

Size 5, 6, 8 mm

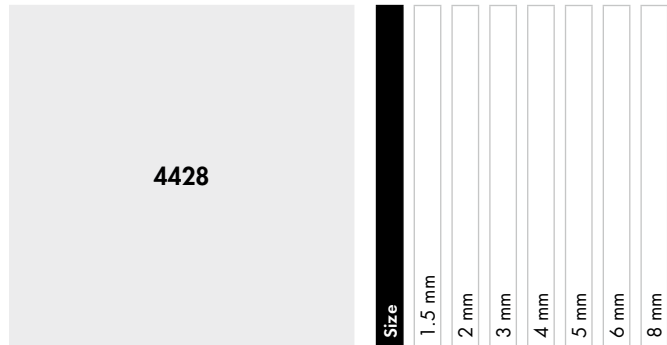

**Crystal**

Crystal F (001)

**Colors**

**Plain Colors**

Amethyst F (204)

Aquamarine F (202)

Black Diamond F (215)

Burgundy F (515)

Dark Moss Green F (260)

Denim Blue F (266)

Emerald F (205)

Fuchsia F (502)

Greige F (284)

Indicolite F (379)

Jet (280)

Light Amethyst F (212)

Light Colorado Topaz F (246)

Light Peach F (362)

Light Rose F (223)

Light Sapphire F (211)

Light Siam F (227)

Light Silk F (261)

Light Smoked Topaz F (221)

Light Turquoise F (263)

Montana F (207)

Peridot F (214)

Rose F (209)

Rose Peach F (262)

Sapphire F (206)

Siam F (208)

Smoked Topaz F (220)

Smoky Quartz F (225)

Tangerine F (259)

Tanzanite F (539)

Violet F (371)

**Opal Colors**

White Opal F (234)

**Crystal Effects**

**Transparent Effects**

Crystal AB F (001 AB)

Crystal Antique Pink F (001 ANTP)

Size  
1.5 mm  
2 mm  
3 mm  
4 mm  
5 mm  
6 mm  
8 mm

|                                   |   |   |   |   |   |   |   |
|-----------------------------------|---|---|---|---|---|---|---|
| Crystal F (001)                   | ■ | ■ | ■ | ■ | ■ | ■ | ■ |
| Amethyst F (204)                  | ■ | ■ | ■ | ■ | ■ | ■ | ■ |
| Aquamarine F (202)                | ■ | ■ | ■ | ■ | ■ | ■ | ■ |
| Black Diamond F (215)             | ■ | ■ | ■ | ■ | ■ | ■ | ■ |
| Burgundy F (515)                  | ■ | ■ | ■ | ■ | ■ | ■ | ■ |
| Dark Moss Green F (260)           | ■ | ■ | ■ | ■ | ■ | ■ | ■ |
| Denim Blue F (266)                | ■ | ■ | ■ | ■ | ■ | ■ | ■ |
| Emerald F (205)                   | ■ | ■ | ■ | ■ | ■ | ■ | ■ |
| Fuchsia F (502)                   | ■ | ■ | ■ | ■ | ■ | ■ | ■ |
| Greige F (284)                    | ■ | ■ | ■ | ■ | ■ | ■ | ■ |
| Indicolite F (379)                | ■ | ■ | ■ | ■ | ■ | ■ | ■ |
| Jet (280)                         | ■ | ■ | ■ | ■ | ■ | ■ | ■ |
| Light Amethyst F (212)            | ■ | ■ | ■ | ■ | ■ | ■ | ■ |
| Light Colorado Topaz F (246)      | ■ | ■ | ■ | ■ | ■ | ■ | ■ |
| Light Peach F (362)               | ■ | ■ | ■ | ■ | ■ | ■ | ■ |
| Light Rose F (223)                | ■ | ■ | ■ | ■ | ■ | ■ | ■ |
| Light Sapphire F (211)            | ■ | ■ | ■ | ■ | ■ | ■ | ■ |
| Light Siam F (227)                | ■ | ■ | ■ | ■ | ■ | ■ | ■ |
| Light Silk F (261)                | ■ | ■ | ■ | ■ | ■ | ■ | ■ |
| Light Smoked Topaz F (221)        | ■ | ■ | ■ | ■ | ■ | ■ | ■ |
| Light Turquoise F (263)           | ■ | ■ | ■ | ■ | ■ | ■ | ■ |
| Montana F (207)                   | ■ | ■ | ■ | ■ | ■ | ■ | ■ |
| Peridot F (214)                   | ■ | ■ | ■ | ■ | ■ | ■ | ■ |
| Rose F (209)                      | ■ | ■ | ■ | ■ | ■ | ■ | ■ |
| Rose Peach F (262)                | ■ | ■ | ■ | ■ | ■ | ■ | ■ |
| Sapphire F (206)                  | ■ | ■ | ■ | ■ | ■ | ■ | ■ |
| Siam F (208)                      | ■ | ■ | ■ | ■ | ■ | ■ | ■ |
| Smoked Topaz F (220)              | ■ | ■ | ■ | ■ | ■ | ■ | ■ |
| Smoky Quartz F (225)              | ■ | ■ | ■ | ■ | ■ | ■ | ■ |
| Tangerine F (259)                 | ■ | ■ | ■ | ■ | ■ | ■ | ■ |
| Tanzanite F (539)                 | ■ | ■ | ■ | ■ | ■ | ■ | ■ |
| Violet F (371)                    | ■ | ■ | ■ | ■ | ■ | ■ | ■ |
| White Opal F (234)                | ■ | ■ | ■ | ■ | ■ | ■ | ■ |
| Crystal AB F (001 AB)             | ■ | ■ | ■ | ■ | ■ | ■ | ■ |
| Crystal Antique Pink F (001 ANTP) | ■ | ■ | ■ | ■ | ■ | ■ | ■ |

# Fancy Stones & Settings

| 4428                    |  | Size | 1.5 mm | 2 mm | 3 mm | 4 mm | 5 mm | 6 mm | 8 mm |
|-------------------------|--|------|--------|------|------|------|------|------|------|
|                         | Crystal Blue Shade F (001 BLSH)          |      | ■      | ■    | ■    | ■    |      | ■    | ■    |
|                         | Crystal Golden Shadow F (001 GSHA)       |      | ■      | ■    | ■    | ■    |      | ■    | ■    |
|                         | Crystal Lilac Shadow F (001 LISH)        |      | ■      | ■    | ■    | ■    |      | ■    | ■    |
|                         | Crystal Luminous Green F (001 LUMG)      |      | ■      | ■    | ■    | ■    |      | ■    | ■    |
|                         | Crystal Silver Night F (001 SINI)        |      | ■      | ■    | ■    | ■    |      | ■    | ■    |
|                         | Crystal Silver Shade F (001 SSHA)        |      | ■      | ■    | ■    | ■    |      | ■    | ■    |
| <b>Metallic Effects</b> |  |      |        |      |      |      |      |      |      |
|                         | Crystal Iridescent Green F (001 IRIG)    |      |        | ■    | ■    | ■    |      | ■    | ■    |
|                         | Crystal Metallic Light Gold F (001 MLGD) |      | ■      | ■    | ■    | ■    |      | ■    | ■    |
|                         | Crystal Rose Gold F (001 ROGL)           |      | ■      | ■    | ■    | ■    |      | ■    | ■    |
| <b>Color Effects</b>    |  |      |        |      |      |      |      |      |      |
| <b>Metallic Effects</b> |  |      |        |      |      |      |      |      |      |
|                         | Jet Hematite (280 HEM)                   |      | ■      | ■    | ■    | ■    |      |      |      |

## 4428/S

| 4428/S |  | Size | 4 mm | 5 mm | 6 mm | 8 mm |
|--------|--|------|------|------|------|------|
|        |  |      |      |      |      |      |
|        |  |      |      |      |      |      |

| Ring/Hole, Back Configuration |                                  | 4 mm | 5 mm | 6 mm | 8 mm |
|-------------------------------|----------------------------------|------|------|------|------|
| <input type="checkbox"/>      | 00 C = No ring/hole, closed      | ■    | ■    | ■    | ■    |
| <input type="checkbox"/>      | H2 O = 4 holes/2 each side, open | ■    | ■    | ■    | ■    |

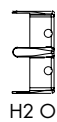
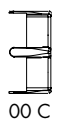

# Fancy Stones & Settings

## 4439 Square Ring Fancy Stone

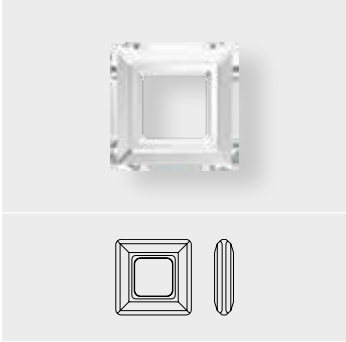

| Size | 14 mm | 20 mm | 30 mm |
|------|-------|-------|-------|
|------|-------|-------|-------|

### Crystal

|  |                          |                          |                          |
|--|--------------------------|--------------------------|--------------------------|
| <input type="checkbox"/> Crystal (001)                   | <input type="checkbox"/> | <input type="checkbox"/> | <input type="checkbox"/> |
| <input type="checkbox"/> Crystal CAL V SI (001 CAL V SI) | <input type="checkbox"/> | <input type="checkbox"/> | <input type="checkbox"/> |

### Colors

#### Plain Colors

|                                    |                          |                          |  |
|------------------------------------|--------------------------|--------------------------|--|
| <input type="checkbox"/> Jet (280) | <input type="checkbox"/> | <input type="checkbox"/> |  |
|------------------------------------|--------------------------|--------------------------|--|

### Crystal Effects

#### Transparent Effects

|  |                          |                          |  |
|--|--------------------------|--------------------------|--|
| <input type="checkbox"/> Crystal AB (001 AB)               | <input type="checkbox"/> | <input type="checkbox"/> |  |
| <input type="checkbox"/> Crystal Bermuda Blue (001 BBL)    | <input type="checkbox"/> | <input type="checkbox"/> |  |
| <input type="checkbox"/> Crystal Golden Shadow (001 GSHA)  | <input type="checkbox"/> | <input type="checkbox"/> |  |
| <input type="checkbox"/> Crystal Lilac Shadow (001 LISH)   | <input type="checkbox"/> | <input type="checkbox"/> |  |
| <input type="checkbox"/> Crystal Luminous Green (001 LUMG) | <input type="checkbox"/> | <input type="checkbox"/> |  |
| <input type="checkbox"/> Crystal Silver Night (001 SINI)   | <input type="checkbox"/> | <input type="checkbox"/> |  |
| <input type="checkbox"/> Crystal Vitrail Light (001 VL)    | <input type="checkbox"/> | <input type="checkbox"/> |  |
| <input type="checkbox"/> Crystal Volcano (001 VOL)         | <input type="checkbox"/> | <input type="checkbox"/> |  |

# Fancy Stones & Settings

## 4447 Princess Square Fancy Stone



| Crystal                            | 6 mm | 8 mm | 10 mm | 12 mm |
|------------------------------------|------|------|-------|-------|
| Crystal F (001)                    | ■    | ■    | ■     | ■     |
| Colors                             |      |      |       |       |
| Plain Colors                       |      |      |       |       |
| Aquamarine F (202)                 |      |      |       | ■     |
| Tanzanite F (539)                  |      |      |       | ■     |
| Crystal Effects                    |      |      |       |       |
| Transparent Effects                |      |      |       |       |
| Crystal Golden Shadow F (001 GSHA) | ■    | ■    | ■     | ■     |
| Crystal Silver Shade F (001 SSHA)  | ■    | ■    | ■     | ■     |

## 4447/S

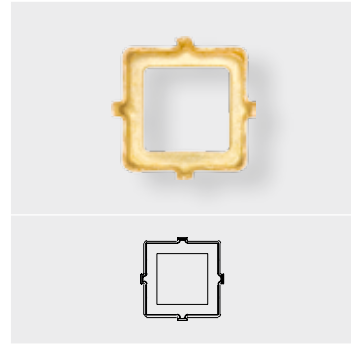

| Ring/Hole, Back Configuration    | 6 mm | 8 mm | 10 mm | 12 mm |
|----------------------------------|------|------|-------|-------|
| 00 C = No ring/hole, closed      | ■    | ■    | ■     | ■     |
| H2 O = 4 holes/2 each side, open | ■    | ■    | ■     | ■     |

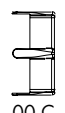

00 C

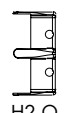

H2 O

## 4461 Classical Square Fancy Stone



| Crystal                            | 8 mm | 12 mm | 16 mm |
|------------------------------------|------|-------|-------|
| Crystal F (001)                    | ■    | ■     | ■     |
| Crystal Effects                    |      |       |       |
| Transparent Effects                |      |       |       |
| Crystal Golden Shadow F (001 GSHA) | ■    | ■     | ■     |
| Crystal Satin F (001 SAT)          | ■    | ■     | ■     |
| Crystal Silver Shade F (001 SSHA)  | ■    | ■     | ■     |

## 4461/S

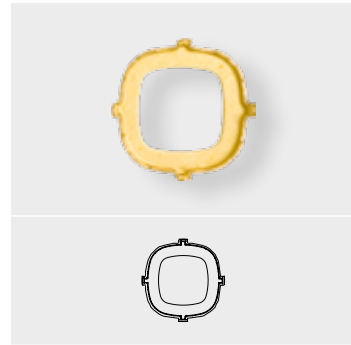

| Ring/Hole, Back Configuration    | 8 mm | 12 mm | 16 mm |
|----------------------------------|------|-------|-------|
| 00 C = No ring/hole, closed      | ■    | ■     | ■     |
| H2 O = 4 holes/2 each side, open | ■    | ■     | ■     |

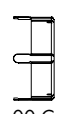

00 C

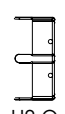

H2 O



# Fancy Stones & Settings

4470



| Size | 10 mm | 12 mm | 18 mm |
|------|-------|-------|-------|
|------|-------|-------|-------|

**Crystal**

- Crystal (001)
- Crystal F (001)

**Colors**

**Plain Colors**

- Aquamarine F (202)
- Black Diamond F (215)
- Burgundy F (515)
- Chrysolite F (238)
- Dark Moss Green F (260)
- Denim Blue F (266)
- Erinite F (360)
- Fern Green F (291)
- Greige F (284)
- Indian Pink F (289)
- Jet (280)
- Indicolite F (379)
- Light Azore F (361)
- Light Colorado Topaz F (246)
- Light Peach F (362)
- Light Silk F (261)
- Light Smoked Topaz F (221)
- Light Turquoise F (263)
- Padparadscha F (542)
- Provence Lavender (283)
- Provence Lavender F (283)
- Purple Velvet F (277)
- Rosaline F (508)
- Rose Peach F (262)
- Siam F (208)
- Smoked Topaz F (220)
- Smoky Quartz F (225)
- Tangerine F (259)
- Tanzanite F (539)
- Vintage Rose F (319)
- Violet F (371)

**Opal Colors**

- Air Blue Opal F (285)
- Chrysolite Opal F (294)
- Pacific Opal F (390)
- Palace Green Opal F (393)



| Size | 10 mm | 12 mm | 18 mm |
|------|-------|-------|-------|
|------|-------|-------|-------|

- Rose Water Opal F (395)
- White Opal F (234)

**Crystal Effects**

**Transparent Effects**

- Crystal Antique Pink F (001 ANTP)
- Crystal Astral Pink F (001 API)
- Crystal Blue Shade F (001 BLSH)
- Crystal Golden Shadow (001 GSHA)
- Crystal Golden Shadow F (001 GSHA)
- Crystal Lilac Shadow F (001 LISH)
- Crystal Luminous Green (001 LUMG)
- Crystal Luminous Green F (001 LUMG)
- Crystal Moonlight F (001 MOL)
- Crystal Silver Night F (001 SINI)
- Crystal Silver Shade (001 SSHA)
- Crystal Silver Shade F (001 SSHA)

**Metallic Effects**

- Crystal Iridescent Green F (001 IRIG)
- Crystal Rose Gold F (001 ROGL)

**Crystal Patina**

- Crystal Black Patina F (001 BLAPA)
- Crystal Gold Patina F (001 GOLPA)
- Crystal Rose Patina F (001 ROSPA)
- Crystal Silver Patina F (001 SILPA)
- Crystal White Patina F (001 WHIPA)

# Fancy Stones & Settings

## 4470/S

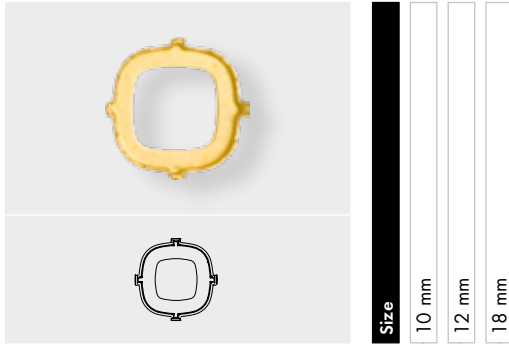

### Ring/Hole, Back Configuration

- 00 C = No ring/hole, closed
- H2 O = 4 holes/2 each side, open



| Size  |
|-------|
| 10 mm |
| 12 mm |
| 18 mm |

## 4500

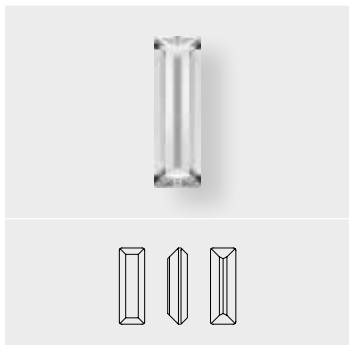

### Crystal

- Crystal F (001)

### Colors

#### Plain Colors

- Amethyst F (204)
- Aquamarine F (202)
- Black Diamond F (215)
- Jet (280)
- Jonquil F (213)
- Light Amethyst F (212)
- Light Rose F (223)
- Light Sapphire F (211)
- Light Siam F (227)
- Light Smoked Topaz F (221)
- Montana F (207)
- Rose F (209)
- Rose Peach F (262)
- Smoked Topaz F (220)
- Topaz F (203)

| Size    |
|---------|
| 3x2 mm  |
| 6x2 mm  |
| 10x3 mm |

## 4500/S



### Ring/Hole, Back Configuration

- 00 C = No ring/hole, closed
- H2 O = 4 holes/2 each side, open



| Size    |
|---------|
| 6x2 mm  |
| 10x3 mm |

# Fancy Stones & Settings

## 4501

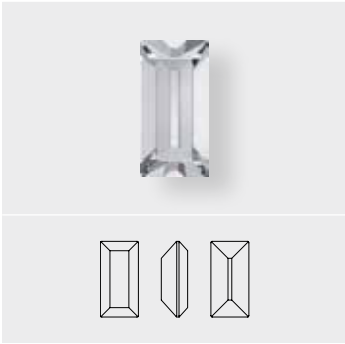

| Size | 4x2 mm | 5x2 mm | 5x2.5 mm | 7x3 mm | 10x5 mm |
|------|--------|--------|----------|--------|---------|
|------|--------|--------|----------|--------|---------|

### Crystal

|                 |   |   |   |   |   |
|-----------------|---|---|---|---|---|
| Crystal F (001) | ■ | ■ | ■ | ■ | ■ |
|-----------------|---|---|---|---|---|

### Colors

#### Plain Colors

|                            |   |   |   |   |   |
|----------------------------|---|---|---|---|---|
| Amethyst F (204)           | ■ | ■ | ■ | ■ | ■ |
| Aquamarine F (202)         | ■ |   |   | ■ | ■ |
| Black Diamond F (215)      | ■ | ■ | ■ | ■ | ■ |
| Emerald F (205)            | ■ |   |   | ■ | ■ |
| Erinite F (360)            | ■ |   |   | ■ | ■ |
| Fuchsia F (502)            | ■ |   |   | ■ | ■ |
| Indian Siam F (327)        | ■ | ■ | ■ | ■ | ■ |
| Jet (280)                  | ■ |   |   | ■ | ■ |
| Light Amethyst F (212)     | ■ | ■ | ■ | ■ | ■ |
| Light Peach F (362)        | ■ |   |   | ■ | ■ |
| Light Rose F (223)         | ■ | ■ | ■ | ■ | ■ |
| Light Sapphire F (211)     | ■ | ■ | ■ | ■ | ■ |
| Light Smoked Topaz F (221) | ■ |   |   | ■ | ■ |
| Montana F (207)            | ■ | ■ | ■ | ■ | ■ |
| Peridot F (214)            | ■ |   |   | ■ | ■ |
| Rose F (209)               | ■ |   |   | ■ | ■ |
| Sapphire F (206)           | ■ |   |   | ■ | ■ |
| Siam F (208)               | ■ |   |   | ■ | ■ |
| Smoked Topaz F (220)       | ■ | ■ | ■ | ■ | ■ |
| Tanzanite F (539)          | ■ |   |   | ■ | ■ |
| Topaz F (203)              | ■ |   |   | ■ | ■ |
| Violet F (371)             | ■ |   |   | ■ | ■ |

### Crystal Effects

#### Transparent Effects

|                                    |   |   |   |   |   |
|------------------------------------|---|---|---|---|---|
| Crystal AB F (001 AB)              | ■ | ■ | ■ | ■ | ■ |
| Crystal Golden Shadow F (001 GSHA) | ■ |   |   | ■ | ■ |

#### Metallic Effects

|                                |   |  |  |   |   |
|--------------------------------|---|--|--|---|---|
| Crystal Rose Gold F (001 ROGL) | ■ |  |  | ■ | ■ |
|--------------------------------|---|--|--|---|---|

## 4501/S

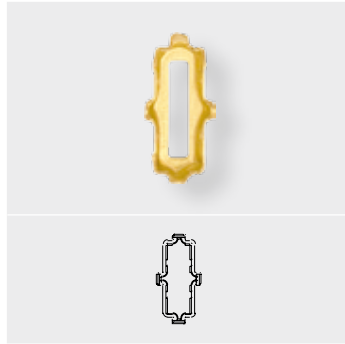

| Size | 5x2.5 mm | 7x3 mm | 10x5 mm |
|------|----------|--------|---------|
|------|----------|--------|---------|

### Ring/Hole, Back Configuration

|                                  |   |   |   |
|----------------------------------|---|---|---|
| 00 C = No ring/hole, closed      | ■ | ■ | ■ |
| H2 O = 4 holes/2 each side, open | ■ | ■ | ■ |

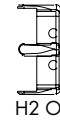
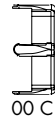

# Fancy Stones & Settings

4502

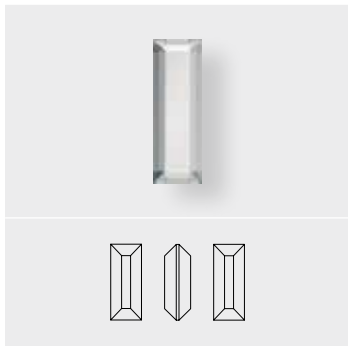

**Size**  
3x1 mm

**Crystal**  
Crystal F (001)

4505 Contour Baguette Fancy Stone



**Size**  
8x5 mm  
10x6 mm  
14x8 mm

**Crystal**  
Crystal F (001)

**Crystal Effects**

**Transparent Effects**  
Crystal Golden Shadow F (001 GSHA)

4505/S

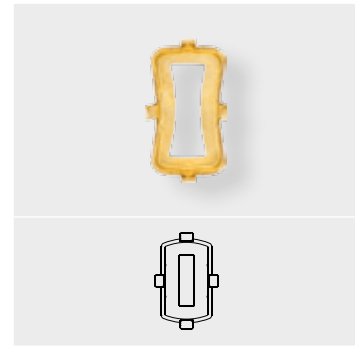

**Size**  
8x5 mm  
10x6 mm  
14x8 mm

**Ring/Hole, Back Configuration**  
00 C = No ring/hole, closed  
H2 O = 4 holes/2 each side, open

00 C      H2 O

# Fancy Stones & Settings

**4524** Pure Baguette Fancy Stone

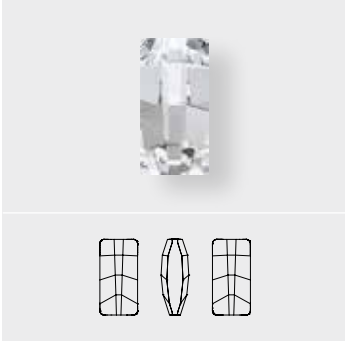

Size 12x6 mm

**4524** Pure Baguette Fancy Stone

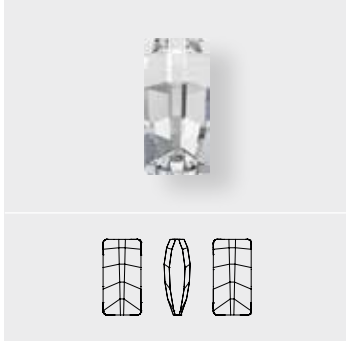

Size 16x8, 23x11 mm

**4524**

|                                     | Size | 12x6 mm                  | 16x8 mm                  | 23x11 mm                 |
|-------------------------------------|------|--------------------------|--------------------------|--------------------------|
| <b>Crystal</b>                      |      |                          |                          |                          |
| Crystal F (001)                     |      | <input type="checkbox"/> | <input type="checkbox"/> | <input type="checkbox"/> |
| <b>Colors</b>                       |      |                          |                          |                          |
| <b>Plain Colors</b>                 |      |                          |                          |                          |
| Amethyst F (204)                    |      | <input type="checkbox"/> | <input type="checkbox"/> | <input type="checkbox"/> |
| Emerald F (205)                     |      | <input type="checkbox"/> | <input type="checkbox"/> | <input type="checkbox"/> |
| Jet (280)                           |      | <input type="checkbox"/> | <input type="checkbox"/> | <input type="checkbox"/> |
| Light Colorado Topaz F (246)        |      | <input type="checkbox"/> | <input type="checkbox"/> | <input type="checkbox"/> |
| Peridot F (214)                     |      | <input type="checkbox"/> | <input type="checkbox"/> | <input type="checkbox"/> |
| <b>Crystal Effects</b>              |      |                          |                          |                          |
| <b>Transparent Effects</b>          |      |                          |                          |                          |
| Crystal AB F (001 AB)               |      | <input type="checkbox"/> | <input type="checkbox"/> | <input type="checkbox"/> |
| Crystal Blue Shade F (001 BLSH)     |      | <input type="checkbox"/> | <input type="checkbox"/> | <input type="checkbox"/> |
| Crystal Golden Shadow F (001 GSHA)  |      | <input type="checkbox"/> | <input type="checkbox"/> | <input type="checkbox"/> |
| Crystal Luminous Green F (001 LUMG) |      | <input type="checkbox"/> | <input type="checkbox"/> | <input type="checkbox"/> |
| Crystal Red Magma F (001 REDM)      |      | <input type="checkbox"/> | <input type="checkbox"/> | <input type="checkbox"/> |
| Crystal Silver Shade F (001 SSHA)   |      | <input type="checkbox"/> | <input type="checkbox"/> | <input type="checkbox"/> |

**4524/S**

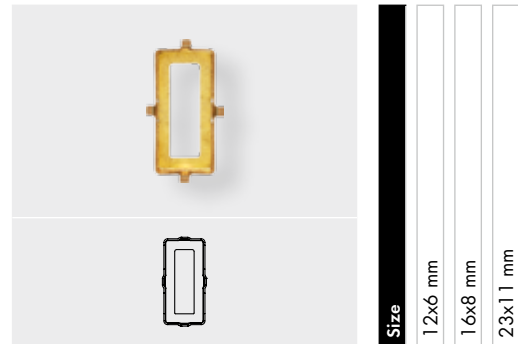

**Ring/Hole, Back Configuration**

00 C = No ring/hole, closed

H2 O = 4 holes/2 each side, open

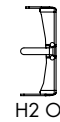
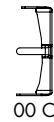

|                                  | Size | 12x6 mm                  | 16x8 mm                  | 23x11 mm                 |
|----------------------------------|------|--------------------------|--------------------------|--------------------------|
| 00 C = No ring/hole, closed      |      | <input type="checkbox"/> | <input type="checkbox"/> | <input type="checkbox"/> |
| H2 O = 4 holes/2 each side, open |      | <input type="checkbox"/> | <input type="checkbox"/> | <input type="checkbox"/> |

# Fancy Stones & Settings

## 4527 Step Cut Fancy Stone

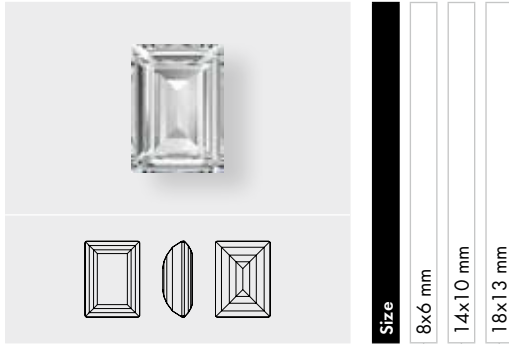

| Crystal                            | 8x6 mm | 14x10 mm | 18x13 mm |
|------------------------------------|--------|----------|----------|
| Crystal F (001)                    | ■      | ■        | ■        |
| Colors                             |        |          |          |
| Plain Colors                       |        |          |          |
| Erinite F (360)                    | ■      | ■        | ■        |
| Light Amethyst F (212)             | ■      | ■        | ■        |
| Montana F (207)                    | ■      | ■        | ■        |
| Smoky Quartz F (225)               | ■      | ■        | ■        |
| Tanzanite F (539)                  | ■      | ■        | ■        |
| Crystal Effect                     |        |          |          |
| Transparent Effects                |        |          |          |
| Crystal Golden Shadow F (001 GSHA) | ■      | ■        | ■        |

## 4527/S

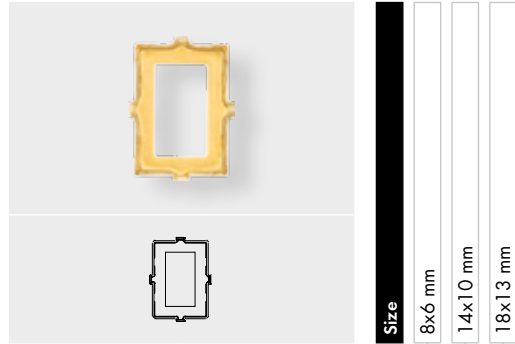

| Ring/Hole, Back Configuration    | 8x6 mm | 14x10 mm | 18x13 mm |
|----------------------------------|--------|----------|----------|
| 00 C = No ring/hole, closed      | ■      | ■        | ■        |
| H2 O = 4 holes/2 each side, open | ■      | ■        | ■        |

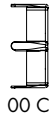

00 C

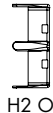

H2 O

## 4547 Princess Baguette Fancy Stone



| Crystal                            | 15x5 mm | 21x7 mm | 24x8 mm | 30x10 mm |
|------------------------------------|---------|---------|---------|----------|
| Crystal F (001)                    | ■       | ■       | ■       | ■        |
| Colors                             |         |         |         |          |
| Plain Colors                       |         |         |         |          |
| Aquamarine F (202)                 | ■       | ■       | ■       | ■        |
| Black Diamond F (215)              | ■       | ■       | ■       | ■        |
| Burgundy F (515)                   | ■       | ■       | ■       | ■        |
| Erinite F (360)                    | ■       | ■       | ■       | ■        |
| Jet (280)                          | ■       | ■       | ■       | ■        |
| Light Rose F (223)                 | ■       | ■       | ■       | ■        |
| Light Smoked Topaz F (221)         | ■       | ■       | ■       | ■        |
| Tanzanite F (539)                  | ■       | ■       | ■       | ■        |
| Crystal Effects                    |         |         |         |          |
| Transparent Effects                |         |         |         |          |
| Crystal Golden Shadow F (001 GSHA) | ■       | ■       | ■       | ■        |
| Crystal Silver Shade F (001 SSHA)  | ■       | ■       | ■       | ■        |

## 4547/S

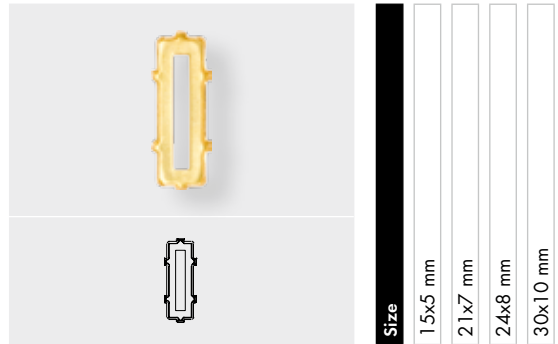

| Ring/Hole, Back Configuration    | 15x5 mm | 21x7 mm | 24x8 mm | 30x10 mm |
|----------------------------------|---------|---------|---------|----------|
| 00 C = No ring/hole, closed      | ■       | ■       | ■       | ■        |
| H2 O = 4 holes/2 each side, open | ■       | ■       | ■       | ■        |

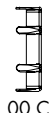

00 C

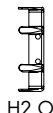

H2 O

# Fancy Stones & Settings

## 4565 Classical Baguette Fancy Stone

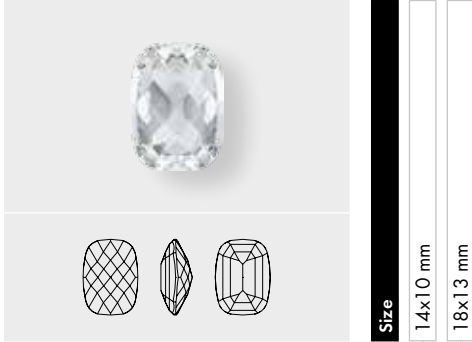

Size

14x10 mm

18x13 mm

### Crystal

Crystal F (001)

### Colors

#### Plain Colors

Aquamarine F (202)

Tanzanite (539)

Tanzanite F (539)

### Crystal Effects

#### Transparent Effects

Crystal Golden Shadow F (001 GSHA)

## 4565/S

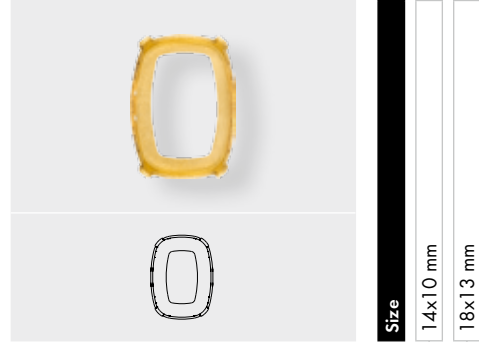

Size

14x10 mm

18x13 mm

### Ring/Hole, Back Configuration

00 C = No ring/hole, closed

H2 O = 4 holes/2 each side, open



00 C



H2 O

# Fancy Stones & Settings

## 4568 Cushion Fancy Stone

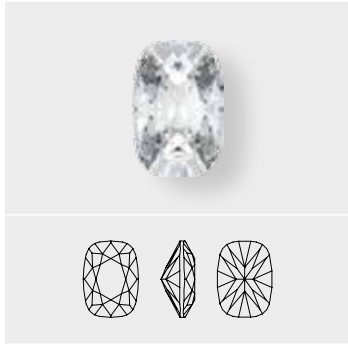

| Size | 8x6 mm | 14x10 mm | 18x13 mm | 27x18 mm |
|------|--------|----------|----------|----------|
|------|--------|----------|----------|----------|

### Crystal

|                 |   |   |   |   |
|-----------------|---|---|---|---|
| Crystal F (001) | ■ | ■ | ■ | ■ |
|-----------------|---|---|---|---|

### Colors

#### Plain Colors

|                              |   |   |   |   |
|------------------------------|---|---|---|---|
| Aquamarine F (202)           | ■ | ■ | ■ | ■ |
| Dark Moss Green F (260)      | ■ | ■ | ■ | ■ |
| Denim Blue F (266)           | ■ | ■ | ■ | ■ |
| Jet (280)                    | ■ | ■ | ■ | ■ |
| Light Colorado Topaz F (246) | ■ | ■ | ■ | ■ |
| Light Siam F (227)           | ■ | ■ | ■ | ■ |
| Rose F (209)                 | ■ | ■ | ■ | ■ |
| Tanzanite F (539)            | ■ | ■ | ■ | ■ |

### Crystal Effects

#### Transparent Effects

|                                     |   |   |   |   |
|-------------------------------------|---|---|---|---|
| Crystal AB F (001 AB)               | ■ | ■ | ■ | ■ |
| Crystal Antique Pink F (001 ANTP)   | ■ | ■ | ■ | ■ |
| Crystal Golden Shadow F (001 GSHA)  | ■ | ■ | ■ | ■ |
| Crystal Lilac Shadow F (001 LISH)   | ■ | ■ | ■ | ■ |
| Crystal Luminous Green F (001 LUMG) | ■ | ■ | ■ | ■ |
| Crystal Silver Night (001 SINI)     | ■ | ■ | ■ | ■ |
| Crystal Silver Shade F (001 SSHA)   | ■ | ■ | ■ | ■ |

#### Metallic Effects

|                                       |   |   |   |   |
|---------------------------------------|---|---|---|---|
| Crystal Iridescent Green F (001 IRIG) | ■ | ■ | ■ | ■ |
|---------------------------------------|---|---|---|---|

#### Crystal Patina

|                                     |   |   |   |   |
|-------------------------------------|---|---|---|---|
| Crystal Black Patina F (001 BLAPA)  | ■ | ■ | ■ | ■ |
| Crystal Gold Patina F (001 GOLPA)   | ■ | ■ | ■ | ■ |
| Crystal Rose Patina F (001 ROSPA)   | ■ | ■ | ■ | ■ |
| Crystal Silver Patina F (001 SILPA) | ■ | ■ | ■ | ■ |
| Crystal White Patina F (001 WHIPA)  | ■ | ■ | ■ | ■ |

## 4568/S

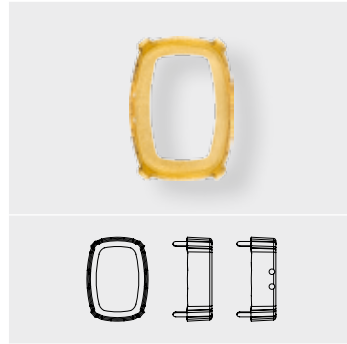

| Size | 8x6 mm | 14x10 mm | 18x13 mm | 27x18 mm |
|------|--------|----------|----------|----------|
|------|--------|----------|----------|----------|

### Ring/Hole, Back Configuration

|                             |   |   |   |   |
|-----------------------------|---|---|---|---|
| 00 C = No ring/hole, closed | ■ | ■ | ■ | ■ |
|-----------------------------|---|---|---|---|

|                                  |   |   |   |   |
|----------------------------------|---|---|---|---|
| H2 O = 4 holes/2 each side, open | ■ | ■ | ■ | ■ |
|----------------------------------|---|---|---|---|

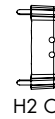



# Fancy Stones & Settings

## 4600

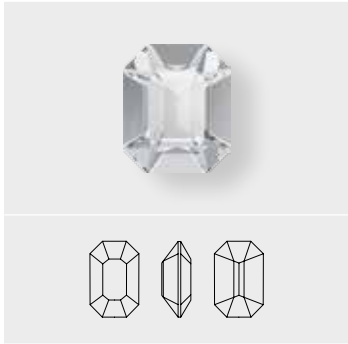

| Size | 6x4 mm | 8x6 mm | 10x8 mm | 12x10 mm |
|------|--------|--------|---------|----------|
|------|--------|--------|---------|----------|

### Crystal

Crystal F (001)

### Colors

#### Plain Colors

Jet (280)

Montana F (207)

Rose F (209)

### Crystal Effects

#### Transparent Effects

Crystal Golden Shadow F (001 GSHA)

Crystal Silver Shade F (001 SSHA)

## 4600/S

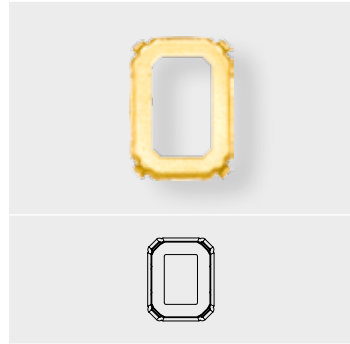

| Size | 6x4 mm | 8x6 mm | 10x8 mm | 12x10 mm |
|------|--------|--------|---------|----------|
|------|--------|--------|---------|----------|

### Ring/Hole, Back Configuration

00 C = No ring/hole, closed

H2 O = 4 holes/2 each side, open

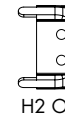
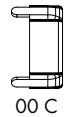

# Fancy Stones & Settings

## 4610

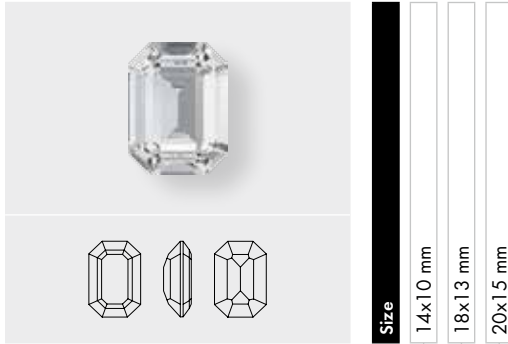

| Crystal                            | 14x10 mm                            | 18x13 mm                            | 20x15 mm                            |
|------------------------------------|-------------------------------------|-------------------------------------|-------------------------------------|
| Crystal F (001)                    | <input checked="" type="checkbox"/> | <input checked="" type="checkbox"/> | <input checked="" type="checkbox"/> |
| <b>Colors</b>                      |                                     |                                     |                                     |
| <b>Plain Colors</b>                |                                     |                                     |                                     |
| Amethyst F (204)                   | <input checked="" type="checkbox"/> | <input checked="" type="checkbox"/> | <input checked="" type="checkbox"/> |
| Aquamarine F (202)                 | <input checked="" type="checkbox"/> | <input checked="" type="checkbox"/> | <input checked="" type="checkbox"/> |
| Black Diamond F (215)              | <input checked="" type="checkbox"/> | <input checked="" type="checkbox"/> | <input checked="" type="checkbox"/> |
| Dark Moss Green F (260)            | <input checked="" type="checkbox"/> | <input checked="" type="checkbox"/> | <input checked="" type="checkbox"/> |
| Emerald F (205)                    | <input checked="" type="checkbox"/> | <input checked="" type="checkbox"/> | <input checked="" type="checkbox"/> |
| Jet (280)                          | <input checked="" type="checkbox"/> | <input checked="" type="checkbox"/> | <input checked="" type="checkbox"/> |
| Light Colorado Topaz F (246)       | <input checked="" type="checkbox"/> | <input checked="" type="checkbox"/> | <input checked="" type="checkbox"/> |
| Montana F (207)                    | <input checked="" type="checkbox"/> | <input checked="" type="checkbox"/> | <input checked="" type="checkbox"/> |
| Peridot F (214)                    | <input checked="" type="checkbox"/> | <input checked="" type="checkbox"/> | <input checked="" type="checkbox"/> |
| Siam F (208)                       | <input checked="" type="checkbox"/> | <input checked="" type="checkbox"/> | <input checked="" type="checkbox"/> |
| Tanzanite F (539)                  | <input checked="" type="checkbox"/> | <input checked="" type="checkbox"/> | <input checked="" type="checkbox"/> |
| Topaz F (203)                      | <input checked="" type="checkbox"/> | <input checked="" type="checkbox"/> | <input checked="" type="checkbox"/> |
| <b>Crystal Effects</b>             |                                     |                                     |                                     |
| <b>Transparent Effects</b>         |                                     |                                     |                                     |
| Crystal Golden Shadow F (001 GSHA) | <input checked="" type="checkbox"/> | <input checked="" type="checkbox"/> | <input checked="" type="checkbox"/> |
| Crystal Silver Shade F (001 SSHA)  | <input checked="" type="checkbox"/> | <input checked="" type="checkbox"/> | <input checked="" type="checkbox"/> |

## 4610/S

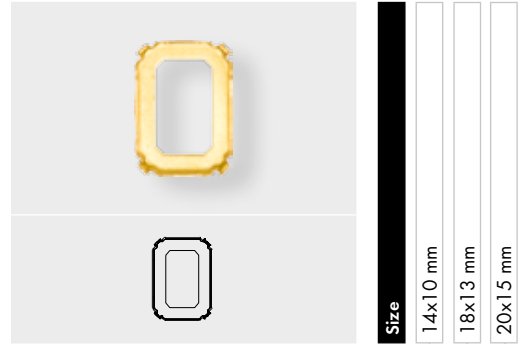

| Ring/Hole, Back Configuration    | 14x10 mm                            | 18x13 mm                            | 20x15 mm                            |
|----------------------------------|-------------------------------------|-------------------------------------|-------------------------------------|
| 00 C = No ring/hole, closed      | <input checked="" type="checkbox"/> | <input checked="" type="checkbox"/> | <input checked="" type="checkbox"/> |
| H2 O = 4 holes/2 each side, open | <input checked="" type="checkbox"/> | <input checked="" type="checkbox"/> | <input checked="" type="checkbox"/> |

00 C

H2 O

# Fancy Stones & Settings

4627

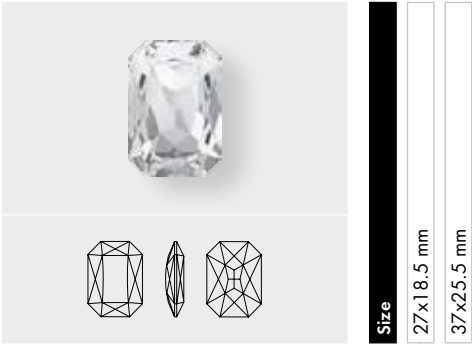

**Crystal**

Crystal F (001)

**Colors**

**Plain Colors**

- Amethyst F (204)
- Aquamarine F (202)
- Black Diamond F (215)
- Burgundy F (515)
- Dark Moss Green F (260)
- Emerald F (205)
- Jet (280)
- Light Colorado Topaz F (246)
- Montana F (207)
- Tanzanite F (539)

**Crystal Effects**

**Transparent Effects**

- Crystal AB F (001 AB)
- Crystal Golden Shadow F (001 GSHA)
- Crystal Moonlight F (001 MOL)
- Crystal Red Magma F (001 REDM)
- Crystal Silver Shade F (001 SSHA)
- Crystal Vitrail Medium (001 VM)

**Color Effect**

**Metallic Effects**

Jet Hematite (280 HEM)

4627/S

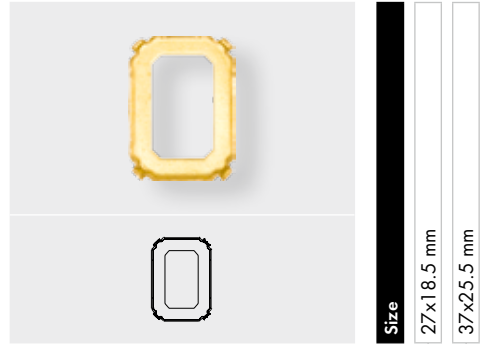

**Ring/Hole, Back Configuration**

00 C = No ring/hole, closed

H2 O = 4 holes/2 each side, open

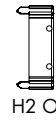

# Fancy Stones & Settings

4675



Size  
23 mm

**Crystal**

Crystal F (001)

**Crystal Effects**

**Transparent Effects**

Crystal Golden Shadow F (001 GSHA)

Crystal Silver Shade F (001 SSHA)

4675/S

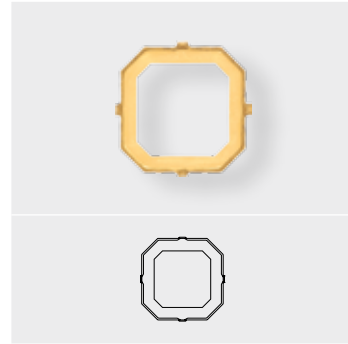

Size  
23 mm

**Ring/Hole, Back Configuration**

00 C = No ring/hole, closed

H2 O = 4 holes/2 each side, open

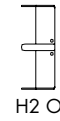

# Fancy Stones & Settings

## 4678 Solaris Fancy Stone

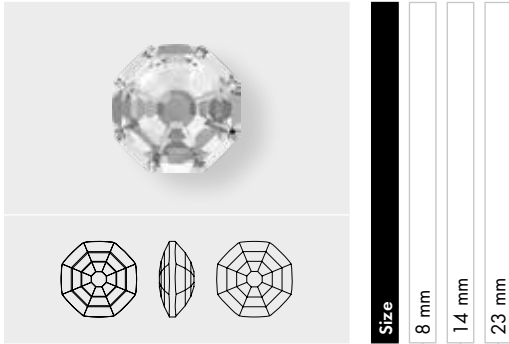

| Crystal                               | 8 mm                                | 14 mm                               | 23 mm                               |
|---------------------------------------|-------------------------------------|-------------------------------------|-------------------------------------|
| Crystal F (001)                       | <input checked="" type="checkbox"/> | <input checked="" type="checkbox"/> | <input checked="" type="checkbox"/> |
| Colors                                |                                     |                                     |                                     |
| Plain Colors                          |                                     |                                     |                                     |
| Aquamarine F (202)                    | <input checked="" type="checkbox"/> | <input checked="" type="checkbox"/> | <input checked="" type="checkbox"/> |
| Dark Moss Green F (260)               | <input checked="" type="checkbox"/> | <input checked="" type="checkbox"/> | <input checked="" type="checkbox"/> |
| Jet (280)                             | <input checked="" type="checkbox"/> | <input checked="" type="checkbox"/> | <input checked="" type="checkbox"/> |
| Crystal Effects                       |                                     |                                     |                                     |
| Transparent Effects                   |                                     |                                     |                                     |
| Crystal AB F (001 AB)                 | <input checked="" type="checkbox"/> | <input checked="" type="checkbox"/> | <input checked="" type="checkbox"/> |
| Crystal Antique Pink F (001 ANTP)     | <input checked="" type="checkbox"/> | <input checked="" type="checkbox"/> | <input checked="" type="checkbox"/> |
| Crystal Golden Shadow F (001 GSHA)    | <input checked="" type="checkbox"/> | <input checked="" type="checkbox"/> | <input checked="" type="checkbox"/> |
| Crystal Lilac Shadow F (001 LISH)     | <input checked="" type="checkbox"/> | <input checked="" type="checkbox"/> | <input checked="" type="checkbox"/> |
| Crystal Luminous Green F (001 LUMG)   | <input checked="" type="checkbox"/> | <input checked="" type="checkbox"/> | <input checked="" type="checkbox"/> |
| Crystal Red Magma F (001 REDM)        | <input checked="" type="checkbox"/> | <input checked="" type="checkbox"/> | <input checked="" type="checkbox"/> |
| Crystal Silver Night (001 SINI)       | <input checked="" type="checkbox"/> | <input checked="" type="checkbox"/> | <input checked="" type="checkbox"/> |
| Metallic Effects                      |                                     |                                     |                                     |
| Crystal Iridescent Green F (001 IRIG) | <input checked="" type="checkbox"/> | <input checked="" type="checkbox"/> | <input checked="" type="checkbox"/> |

## 4678/G Solaris Fancy Stone partly frosted

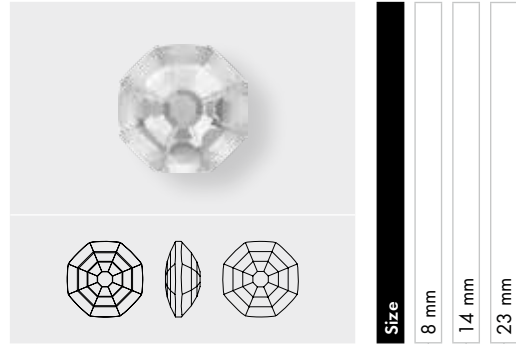

| Crystal                               | 8 mm                                | 14 mm                               | 23 mm                               |
|---------------------------------------|-------------------------------------|-------------------------------------|-------------------------------------|
| Crystal F (001)                       | <input checked="" type="checkbox"/> | <input checked="" type="checkbox"/> | <input checked="" type="checkbox"/> |
| Colors                                |                                     |                                     |                                     |
| Plain Colors                          |                                     |                                     |                                     |
| Aquamarine F (202)                    | <input checked="" type="checkbox"/> | <input checked="" type="checkbox"/> | <input checked="" type="checkbox"/> |
| Dark Moss Green F (260)               | <input checked="" type="checkbox"/> | <input checked="" type="checkbox"/> | <input checked="" type="checkbox"/> |
| Jet (280)                             | <input checked="" type="checkbox"/> | <input checked="" type="checkbox"/> | <input checked="" type="checkbox"/> |
| Crystal Effects                       |                                     |                                     |                                     |
| Transparent Effects                   |                                     |                                     |                                     |
| Crystal AB F (001 AB)                 | <input checked="" type="checkbox"/> | <input checked="" type="checkbox"/> | <input checked="" type="checkbox"/> |
| Crystal Antique Pink F (001 ANTP)     | <input checked="" type="checkbox"/> | <input checked="" type="checkbox"/> | <input checked="" type="checkbox"/> |
| Crystal Golden Shadow F (001 GSHA)    | <input checked="" type="checkbox"/> | <input checked="" type="checkbox"/> | <input checked="" type="checkbox"/> |
| Crystal Lilac Shadow F (001 LISH)     | <input checked="" type="checkbox"/> | <input checked="" type="checkbox"/> | <input checked="" type="checkbox"/> |
| Crystal Luminous Green F (001 LUMG)   | <input checked="" type="checkbox"/> | <input checked="" type="checkbox"/> | <input checked="" type="checkbox"/> |
| Crystal Red Magma F (001 REDM)        | <input checked="" type="checkbox"/> | <input checked="" type="checkbox"/> | <input checked="" type="checkbox"/> |
| Crystal Silver Night (001 SINI)       | <input checked="" type="checkbox"/> | <input checked="" type="checkbox"/> | <input checked="" type="checkbox"/> |
| Metallic Effects                      |                                     |                                     |                                     |
| Crystal Iridescent Green F (001 IRIG) | <input checked="" type="checkbox"/> | <input checked="" type="checkbox"/> | <input checked="" type="checkbox"/> |

## 4678/S

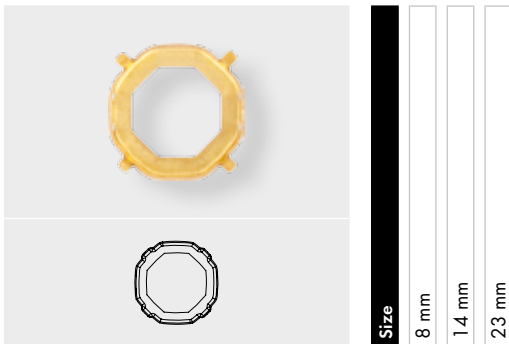

| Ring/Hole, Back Configuration    | 8 mm                                | 14 mm                               | 23 mm                               |
|----------------------------------|-------------------------------------|-------------------------------------|-------------------------------------|
| 00 C = No ring/hole, closed      | <input checked="" type="checkbox"/> | <input checked="" type="checkbox"/> | <input checked="" type="checkbox"/> |
| H2 O = 4 holes/2 each side, open | <input checked="" type="checkbox"/> | <input checked="" type="checkbox"/> | <input checked="" type="checkbox"/> |

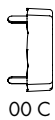

# Fancy Stones & Settings

## 4706 Trilliant Fancy Stone

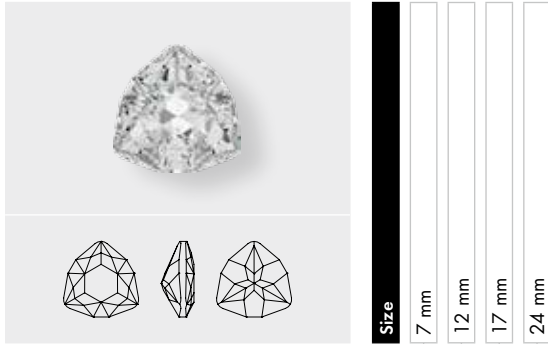

|                                     | 7 mm | 12 mm | 17 mm | 24 mm |
|-------------------------------------|------|-------|-------|-------|
| <b>Crystal</b>                      |      |       |       |       |
| Crystal F (001)                     | ■    | ■     | ■     | ■     |
| <b>Colors</b>                       |      |       |       |       |
| <b>Plain Colors</b>                 |      |       |       |       |
| Amethyst F (204)                    | ■    | ■     | ■     | ■     |
| Aquamarine F (202)                  | ■    | ■     | ■     | ■     |
| Dark Moss Green F (260)             | ■    | ■     | ■     | ■     |
| Light Colorado Topaz F (246)        | ■    | ■     | ■     | ■     |
| Padparadscha F (542)                | ■    | ■     | ■     | ■     |
| Rose F (209)                        | ■    | ■     | ■     | ■     |
| Tanzanite F (539)                   | ■    | ■     | ■     | ■     |
| Vintage Rose F (319)                | ■    | ■     | ■     | ■     |
| <b>Crystal Effects</b>              |      |       |       |       |
| <b>Transparent Effects</b>          |      |       |       |       |
| Crystal AB F (001 AB)               | ■    | ■     | ■     | ■     |
| Crystal Blue Shade F (001 BLSH)     | ■    | ■     | ■     | ■     |
| Crystal Golden Shadow F (001 GSHA)  | ■    | ■     | ■     | ■     |
| Crystal Luminous Green F (001 LUMG) | ■    | ■     | ■     | ■     |
| Crystal Silver Night (001 SINI)     | ■    | ■     | ■     | ■     |
| Crystal Silver Shade F (001 SSHA)   | ■    | ■     | ■     | ■     |
| <b>Crystal Patina</b>               |      |       |       |       |
| Crystal Black Patina F (001 BLAPA)  | ■    | ■     | ■     | ■     |
| Crystal Gold Patina F (001 GOLPA)   | ■    | ■     | ■     | ■     |
| Crystal Rose Patina F (001 ROSPA)   | ■    | ■     | ■     | ■     |
| Crystal Silver Patina F (001 SILPA) | ■    | ■     | ■     | ■     |
| Crystal White Patina F (001 WHIPA)  | ■    | ■     | ■     | ■     |

## 4706/S



|                                      | 7 mm | 12 mm | 17 mm | 24 mm |
|--------------------------------------|------|-------|-------|-------|
| <b>Ring/Hole, Back Configuration</b> |      |       |       |       |
| 00 C = No ring/hole, closed          | ■    | ■     | ■     | ■     |
| H2 O = 4 holes/2 each side, open     | ■    | ■     | ■     | ■     |

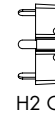
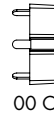

# Fancy Stones & Settings

## 4717 Delta Fancy Stone



Size

15.5 mm

21.5 mm

### Crystal

Crystal F (001)

### Colors

#### Plain Colors

Aquamarine F (202)

Black Diamond F (215)

Denim Blue F (266)

Montana F (207)

Tanzanite F (539)

### Crystal Effects

#### Transparent Effects

Crystal Antique Pink F (001 ANTP)

Crystal Astral Pink F (001 API)

Crystal Golden Shadow F (001 GSHA)

Crystal Red Magma F (001 REDM)

Crystal Silver Shade F (001 SSHA)

## 4717/S

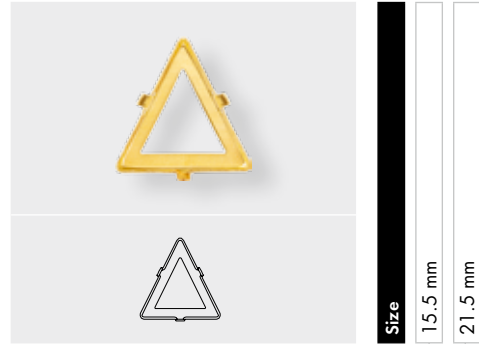

Size

15.5 mm

21.5 mm

### Ring/Hole, Back Configuration

00 C = No ring/hole, closed

H2 O = 4 holes/2 each side, open

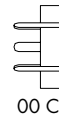

00 C



H2 O

# Fancy Stones & Settings

4722

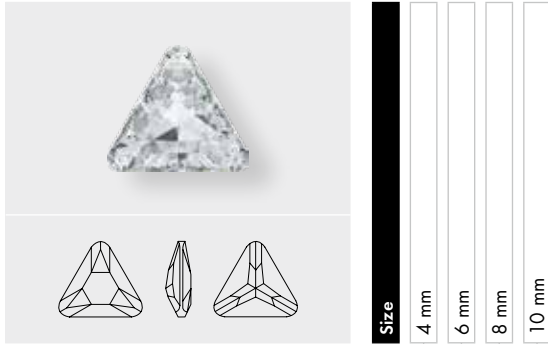

**Crystal**

Crystal F (001)

- Size**
- 4 mm
  - 6 mm
  - 8 mm
  - 10 mm

4722/S

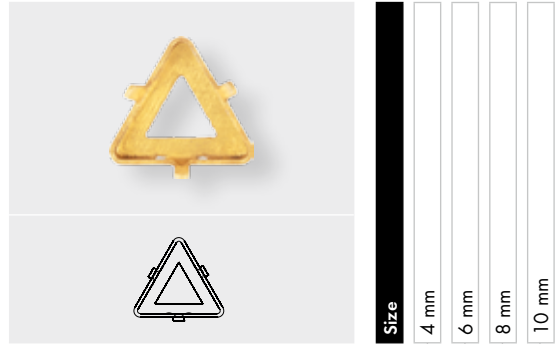

**Ring/Hole, Back Configuration**

00 C = No ring/hole, closed

H2 O = 4 holes/2 each side, open

- Size**
- 4 mm
  - 6 mm
  - 8 mm
  - 10 mm



00 C



H2 O



# Fancy Stones & Settings

4727

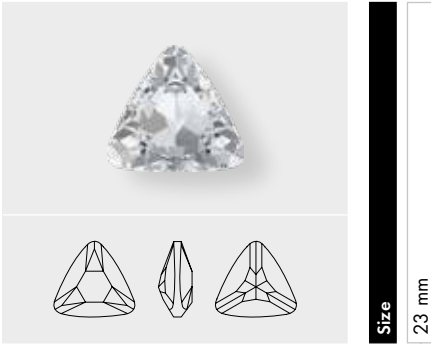

Size

23 mm

**Crystal**

Crystal F (001)

**Crystal Effects**

**Transparent Effects**

Crystal Golden Shadow F (001 GSHA)

Crystal Silver Shade F (001 SSHA)

4727/S

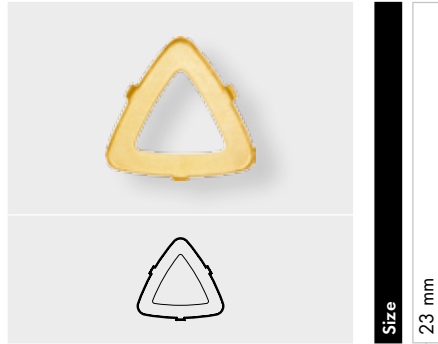

Size

23 mm

**Ring/Hole, Back Configuration**

00 C = No ring/hole, closed

H2 O = 4 holes/2 each side, open

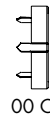

00 C



H2 O

4739 Cosmic Fancy Stone

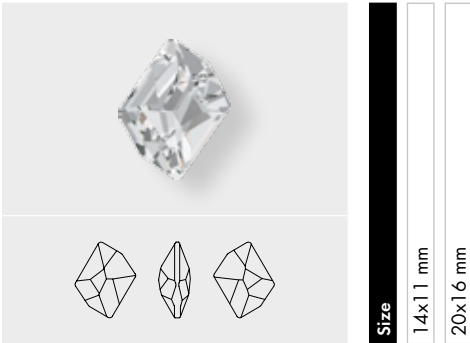

Size

14x11 mm

20x16 mm

**Crystal**

Crystal F (001)

**Colors**

**Plain Colors**

Aquamarine F (202)

Light Amethyst F (212)

Rose F (209)

**Crystal Effects**

**Transparent Effects**

Crystal Golden Shadow F (001 GSHA)

Crystal Silver Shade F (001 SSHA)

4739/S

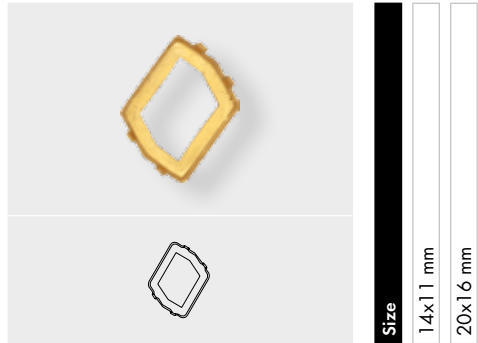

Size

14x11 mm

20x16 mm

**Ring/Hole, Back Configuration**

00 C = No ring/hole, closed

H2 O = 4 holes/2 each side, open



00 C

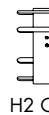

H2 O

# Fancy Stones & Settings

## 4744 Rivoli Flower Fancy Stone

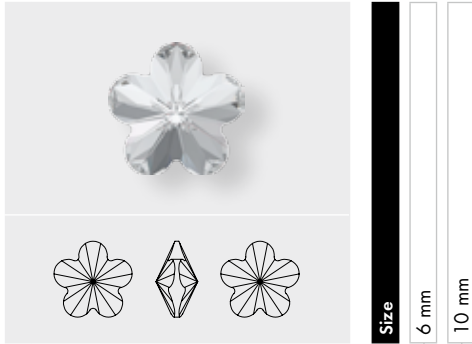

|      |      |       |
|------|------|-------|
| Size | 6 mm | 10 mm |
|------|------|-------|

| Crystal                  |                                   |  |
|--------------------------|-----------------------------------|--|
| <input type="checkbox"/> | Crystal F (001)                   |  |
| Colors                   |                                   |  |
| Plain Colors             |                                   |  |
| <input type="checkbox"/> | Aquamarine F (202)                |  |
| <input type="checkbox"/> | Fuchsia F (502)                   |  |
| <input type="checkbox"/> | Light Rose F (223)                |  |
| <input type="checkbox"/> | Light Siam F (227)                |  |
| <input type="checkbox"/> | Peridot F (214)                   |  |
| <input type="checkbox"/> | Violet F (371)                    |  |
| Crystal Effects          |                                   |  |
| Transparent Effects      |                                   |  |
| <input type="checkbox"/> | Crystal AB F (001 AB)             |  |
| <input type="checkbox"/> | Crystal Lilac Shadow F (001 LISH) |  |

## 4744/S



|      |      |       |
|------|------|-------|
| Size | 6 mm | 10 mm |
|------|------|-------|

| Ring/Hole, Back Configuration |                                  |  |
|-------------------------------|----------------------------------|--|
| <input type="checkbox"/>      | 00 C = No ring/hole, closed      |  |
| <input type="checkbox"/>      | H2 O = 4 holes/2 each side, open |  |



# Fancy Stones & Settings

## 4745 Rivoli Star Fancy Stone

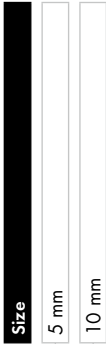

### Crystal

Crystal F (001)

### Colors

#### Plain Colors

Jet (280)

### Crystal Effects

#### Transparent Effects

Crystal AB F (001 AB)

Crystal Bermuda Blue F (001 BBL)

Crystal Golden Shadow F (001 GSHA)

Crystal Silver Shade F (001 SSHA)

Crystal Vitrail Light F (001 VL)

Crystal Vitrail Medium F (001 VM)

#### Metallic Effects

Crystal Rose Gold F (001 ROGL)

### Color Effects

#### Metallic Effects

Jet Hematite (280 HEM)

## 4745/S

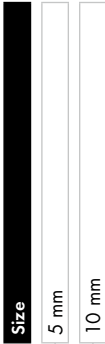
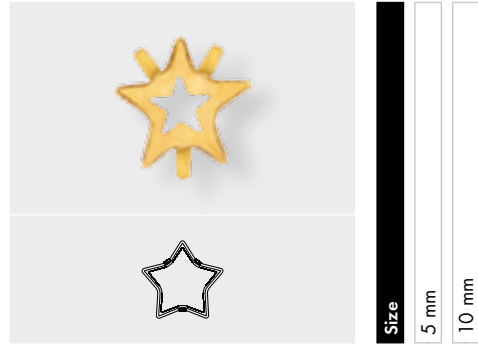

### Ring/Hole, Back Configuration

00 C = No ring/hole, closed

H2 O = 4 holes/2 each side, open



00 C



H2 O

# Fancy Stones & Settings

## 4747 Rivoli Snowflake Fancy Stone

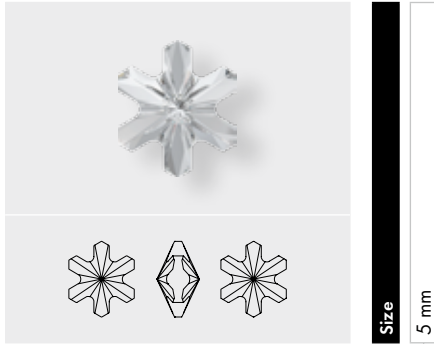

Size 5 mm

### Crystal

Crystal F (001)

### Colors

#### Plain Colors

Erinite F (360)

Indicolite F (379)

Rose Peach F (262)

Tanzanite F (539)

### Crystal Effects

#### Transparent Effects

Crystal AB F (001 AB)

Crystal Golden Shadow F (001 GSHA)

Crystal Silver Night F (001 SINI)

Crystal Vitrail Light F (001 VL)

## 4747/S

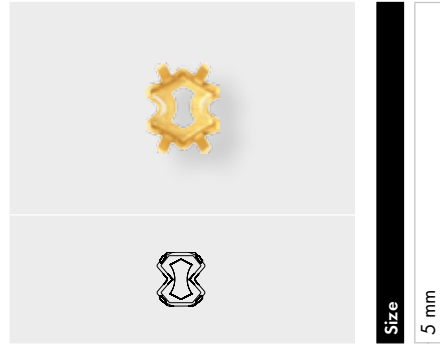

Size 5 mm

### Ring/Hole, Back Configuration

00 C = No ring/hole, closed

H2 O = 4 holes/2 each side, open



00 C



H2 O

## 4748 Rivoli Butterfly Fancy Stone

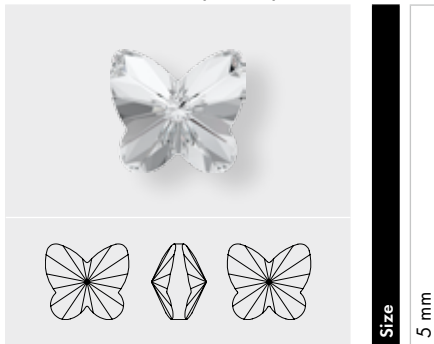

Size 5 mm 10 mm

### Crystal

Crystal F (001)

### Colors

#### Plain Colors

Aquamarine F (202)

Light Amethyst F (212)

Light Rose F (223)

Peridot F (214)

Provence Lavender F (283)

Rose Peach F (262)

### Crystal Effects

#### Transparent Effects

Crystal Astral Pink F (001 API)

Crystal Golden Shadow F (001 GSHA)

Crystal Lilac Shadow F (001 LISH)

## 4748/S

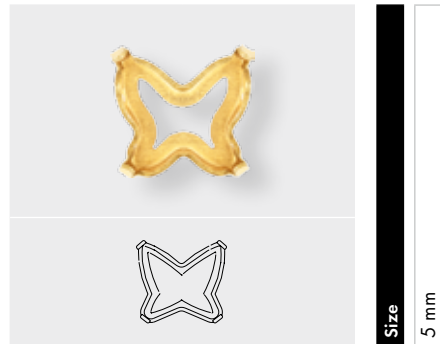

Size 5 mm 10 mm

### Ring/Hole, Back Configuration

00 C = No ring/hole, closed

H2 O = 4 holes/2 each side, open



00 C



H2 O

# Fancy Stones & Settings

## 4756 Galactic Flat Fancy Stone

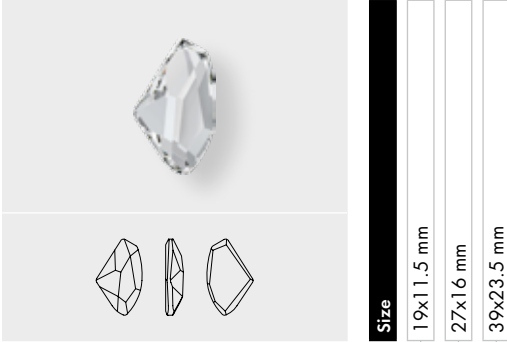

**Size**  
 19x11.5 mm  
 27x16 mm  
 39x23.5 mm

- Crystal**
- Crystal F (001)
- Colors**
- Plain Colors**
- Jet (280)
- Crystal Effects**
- Transparent Effects**
- Crystal Golden Shadow F (001 GSHA)
- Crystal Silver Shade F (001 SSHA)
- Color Effects**
- Metallic Effects**
- Jet Hematite (280 HEM)

## 4756/S

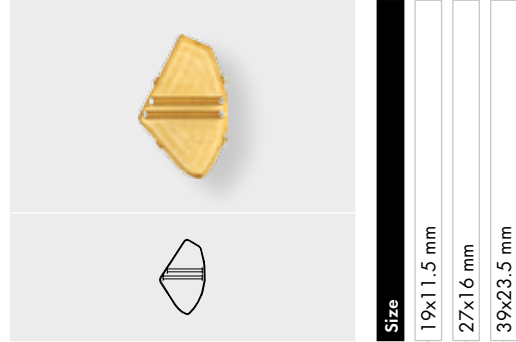

**Size**  
 19x11.5 mm  
 27x16 mm  
 39x23.5 mm

- Ring/Hole, Back Configuration**
- 00 C = No ring/hole, closed
- H2 O = 4 holes/2 each side, open



## 4757 Galactic Fancy Stone



**Size**  
 14x8.5 mm  
 19x11.5 mm

- Crystal**
- Crystal F (001)
- Colors**
- Plain Colors**
- Aquamarine F (202)
- Light Rose F (223)
- Tanzanite F (539)
- Crystal Effects**
- Transparent Effects**
- Crystal Golden Shadow F (001 GSHA)

## 4757/S

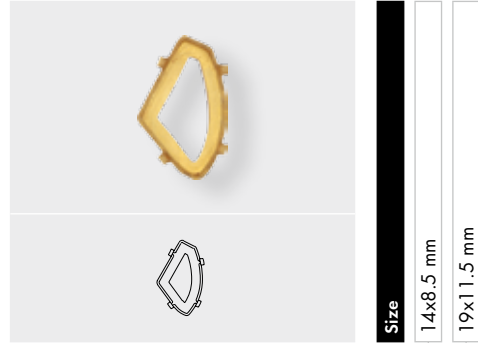

**Size**  
 14x8.5 mm  
 19x11.5 mm

- Ring/Hole, Back Configuration**
- 00 C = No ring/hole, closed
- H2 O = 4 holes/2 each side, open



# Fancy Stones & Settings

## 4760 Calypso Fancy Stone

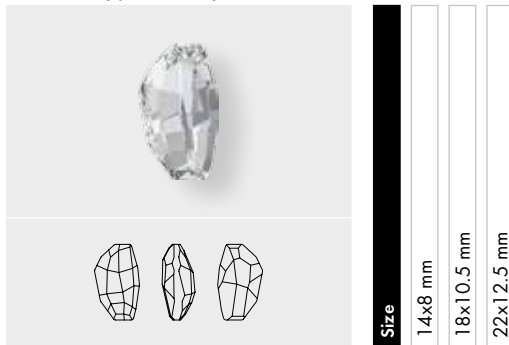

| Crystal                            |                          | 14x8 mm                  | 18x10.5 mm               | 22x12.5 mm               |
|------------------------------------|--------------------------|--------------------------|--------------------------|--------------------------|
| Crystal F (001)                    | <input type="checkbox"/> | <input type="checkbox"/> | <input type="checkbox"/> | <input type="checkbox"/> |
| Colors                             |                          |                          |                          |                          |
| Plain Colors                       |                          |                          |                          |                          |
| Aquamarine F (202)                 | <input type="checkbox"/> | <input type="checkbox"/> | <input type="checkbox"/> | <input type="checkbox"/> |
| Light Rose F (223)                 | <input type="checkbox"/> | <input type="checkbox"/> | <input type="checkbox"/> | <input type="checkbox"/> |
| Crystal Effects                    |                          |                          |                          |                          |
| Transparent Effects                |                          |                          |                          |                          |
| Crystal Golden Shadow F (001 GSHA) | <input type="checkbox"/> | <input type="checkbox"/> | <input type="checkbox"/> | <input type="checkbox"/> |
| Crystal Silver Shade F (001 SSHA)  | <input type="checkbox"/> | <input type="checkbox"/> | <input type="checkbox"/> | <input type="checkbox"/> |

## 4760/S

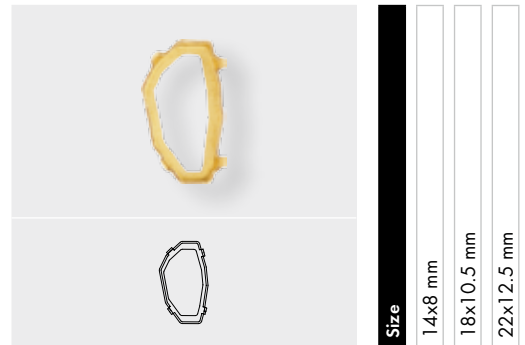

| Ring/Hole, Back Configuration    |                          | 14x8 mm                  | 18x10.5 mm               | 22x12.5 mm               |
|----------------------------------|--------------------------|--------------------------|--------------------------|--------------------------|
| 00 C = No ring/hole, closed      | <input type="checkbox"/> | <input type="checkbox"/> | <input type="checkbox"/> | <input type="checkbox"/> |
| H2 O = 4 holes/2 each side, open | <input type="checkbox"/> | <input type="checkbox"/> | <input type="checkbox"/> | <input type="checkbox"/> |

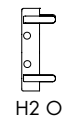
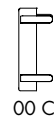

# Fancy Stones & Settings

## 4773 Meteor Fancy Stone

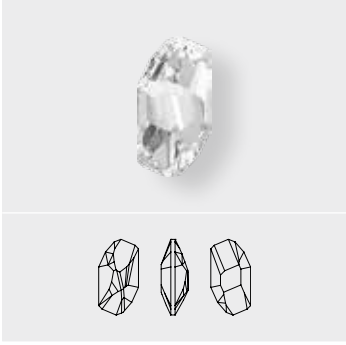

| Size | 14x7.5 mm | 18x9.5 mm | 28x15 mm |
|------|-----------|-----------|----------|
|------|-----------|-----------|----------|

### Crystal

Crystal F (001)

### Colors

#### Plain Colors

Black Diamond F (215)

Jet (280)

Light Turquoise F (263)

Tanzanite F (539)

### Crystal Effects

#### Transparent Effects

Crystal AB F (001 AB)

Crystal Antique Pink F (001 ANTP)

Crystal Blue Shade F (001 BLSH)

Crystal Golden Shadow F (001 GSHA)

Crystal Luminous Green F (001 LUMG)

Crystal Red Magma F (001 REDM)

Crystal Silver Shade F (001 SSHA)

#### Metallic Effects

Crystal Rose Gold F (001 ROGL)

## 4773/S



| Size | 14x7.5 mm | 18x9.5 mm | 28x15 mm |
|------|-----------|-----------|----------|
|------|-----------|-----------|----------|

### Ring/Hole, Back Configuration

00 C = No ring/hole, closed

H2 O = 4 holes/2 each side, open



# Fancy Stones & Settings

**4789** Shell Fancy Stone

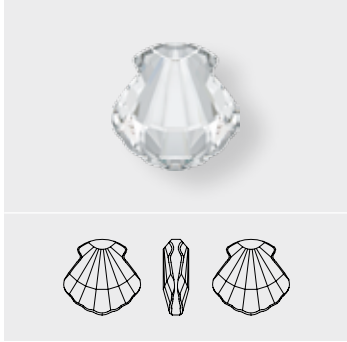

Size 14 mm

**4789** Shell Fancy Stone

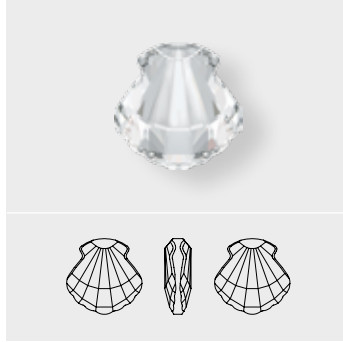

Size 23, 29 mm

**4789**

|                                     | Size 14 mm | 23 mm | 29 mm |
|-------------------------------------|------------|-------|-------|
| <b>Crystal</b>                      |            |       |       |
| Crystal F (001)                     | ■          | ■     | ■     |
| <b>Colors</b>                       |            |       |       |
| <b>Plain Colors</b>                 |            |       |       |
| Aquamarine F (202)                  | ■          | ■     |       |
| Indicolite F (379)                  | ■          | ■     | ■     |
| Provence Lavender F (283)           | ■          | ■     |       |
| <b>Crystal Effects</b>              |            |       |       |
| <b>Transparent Effects</b>          |            |       |       |
| Crystal AB F (001 AB)               | ■          | ■     |       |
| Crystal Antique Pink F (001 ANTP)   | ■          | ■     | ■     |
| Crystal Golden Shadow F (001 GSHA)  | ■          | ■     |       |
| Crystal Luminous Green F (001 LUMG) | ■          | ■     |       |
| Crystal Red Magma F (001 REDM)      | ■          | ■     |       |
| Crystal Silver Night (001 SINI)     | ■          | ■     |       |

**4789/S**

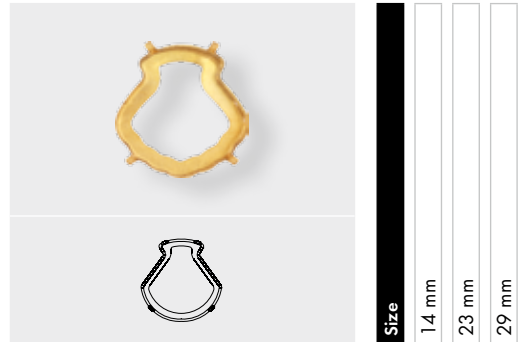

**Ring/Hole, Back Configuration**

00 C = No ring/hole, closed

H2 O = 4 holes/2 each side, open

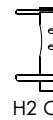



# Fancy Stones & Settings

## 4790 Wing Fancy Stone



| Size | 18x7.5 mm | 23x10 mm | 32x13.5 mm |
|------|-----------|----------|------------|
|------|-----------|----------|------------|

### Crystal

Crystal F (001)

### Colors

#### Plain Colors

Aquamarine F (202)

Fuchsia F (502)

Light Rose F (223)

Provence Lavender F (283)

Tanzanite F (539)

### Crystal Effects

#### Transparent Effects

Crystal Astral Pink F (001 API)

Crystal Golden Shadow F (001 GSHA)

Crystal Red Magma F (001 REDM)

Crystal Silver Shade F (001 SSHA)

## 4790/S

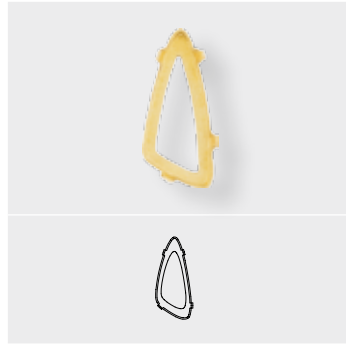

| Size | 18x7.5 mm | 23x10 mm | 32x13.5 mm |
|------|-----------|----------|------------|
|------|-----------|----------|------------|

### Ring/Hole, Back Configuration

00 C = No ring/hole, closed

H2 O = 4 holes/2 each side, open

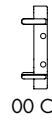

# Fancy Stones & Settings

## 4795 Graphic Fancy Stone

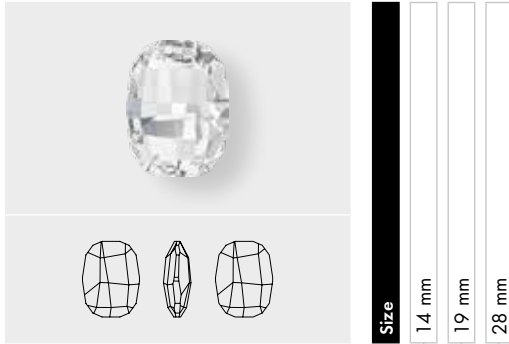

|                                    | 14 mm | 19 mm | 28 mm |
|------------------------------------|-------|-------|-------|
| <b>Crystal</b>                     |       |       |       |
| Crystal F (001)                    | ■     | ■     | ■     |
| <b>Colors</b>                      |       |       |       |
| <b>Plain Colors</b>                |       |       |       |
| Amethyst F (204)                   | ■     | ■     | ■     |
| Aquamarine F (202)                 | ■     | ■     | ■     |
| Black Diamond F (215)              | ■     | ■     | ■     |
| Denim Blue F (266)                 | ■     | ■     | ■     |
| Emerald F (205)                    | ■     | ■     | ■     |
| Light Amethyst F (212)             | ■     | ■     | ■     |
| <b>Crystal Effects</b>             |       |       |       |
| <b>Transparent Effects</b>         |       |       |       |
| Crystal AB F (001 AB)              | ■     | ■     | ■     |
| Crystal Antique Pink F (001 ANTP)  | ■     | ■     | ■     |
| Crystal Astral Pink F (001 API)    | ■     | ■     | ■     |
| Crystal Golden Shadow F (001 GSHA) | ■     | ■     | ■     |
| Crystal Red Magma F (001 REDM)     | ■     | ■     | ■     |
| Crystal Silver Shade F (001 SSHA)  | ■     | ■     | ■     |

## 4795/S

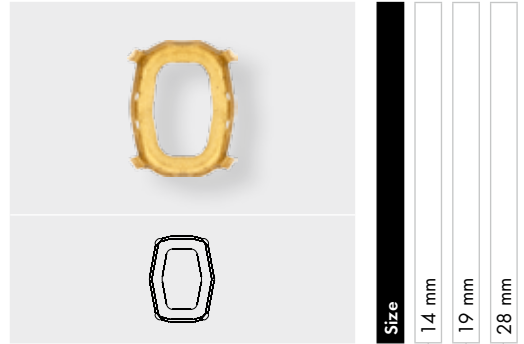

|                                      | 14 mm | 19 mm | 28 mm |
|--------------------------------------|-------|-------|-------|
| <b>Ring/Hole, Back Configuration</b> |       |       |       |
| 00 C = No ring/hole, closed          | ■     | ■     | ■     |
| H2 O = 4 holes/2 each side, open     | ■     | ■     | ■     |

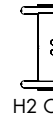
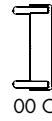

# Fancy Stones & Settings

## 4809 Sweet Heart Fancy Stone



| Size | 13x12 mm | 17x15.5 mm | 27x25 mm |
|------|----------|------------|----------|
|------|----------|------------|----------|

### Crystal

Crystal F (001)

### Colors

#### Plain Colors

- Amethyst F (204)
- Erinite F (360)
- Light Siam F (227)
- Rosaline F (508)
- Rose F (209)
- Violet F (371)

### Crystal Effects

#### Transparent Effects

- Crystal AB F (001 AB)
- Crystal Antique Pink F (001 ANTP)
- Crystal Astral Pink F (001 API)
- Crystal Blue Shade F (001 BLSH)
- Crystal Golden Shadow F (001 GSHA)
- Crystal Lilac Shadow F (001 LISH)
- Crystal Silver Night (001 SINI)
- Crystal Silver Shade F (001 SSHA)

## 4809/S



| Size | 13x12 mm | 17x15.5 mm | 27x25 mm |
|------|----------|------------|----------|
|------|----------|------------|----------|

### Ring/Hole, Back Configuration

00 C = No ring/hole, closed

H2 O = 4 holes/2 each side, open

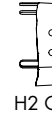
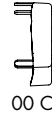

# Fancy Stones & Settings

## 4810 Sweet Heart Fancy Stone

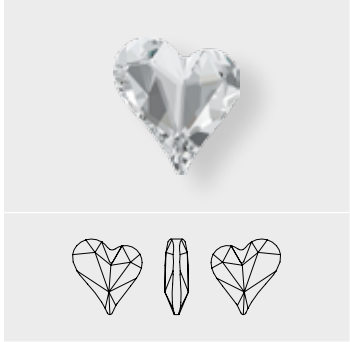

**Size**  
13x12 mm

### Crystal

Crystal F (001)

### Colors

#### Plain Colors

Amethyst F (204)

Erinite F (360)

Light Siam F (227)

Rosaline F (508)

Rose F (209)

Violet F (371)

### Crystal Effects

#### Transparent Effects

Crystal AB F (001 AB)

Crystal Antique Pink F (001 ANTP)

Crystal Astral Pink F (001 API)

Crystal Blue Shade F (001 BLSH)

Crystal Golden Shadow F (001 GSHA)

Crystal Lilac Shadow F (001 LISH)

Crystal Silver Night (001 SINI)

Crystal Silver Shade F (001 SSHA)

## 4810/S



**Size**  
13x12 mm

### Ring/Hole, Back Configuration

00 C = No ring/hole, closed

H2 O = 4 holes/2 each side, open



00 C



H2 O

# Fancy Stones & Settings

4827

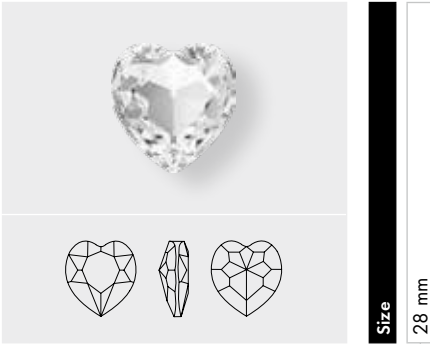

Size

28 mm

**Crystal**

Crystal F (001)

**Colors**

**Plain Colors**

Light Amethyst F (212)

Rosaline F (508)

**Crystal Effects**

**Transparent Effects**

Crystal AB F (001 AB)

Crystal Bermuda Blue (001 BBL)

Crystal Golden Shadow F (001 GSHA)

Crystal Silver Shade F (001 SSHA)

Crystal Vitrail Medium (001 VM)

4827/S

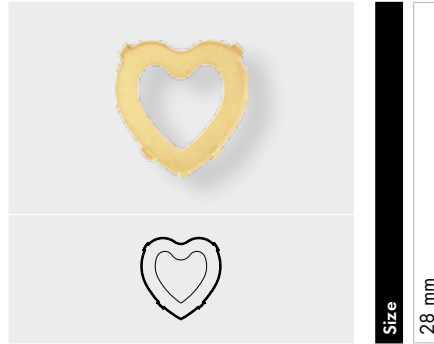

Size

28 mm

**Ring/Hole, Back Configuration**

00 C = No ring/hole, closed

H2 O = 4 holes/2 each side, open



00 C



H2 O

# Fancy Stones & Settings

## 4831 Antique Heart Fancy Stone

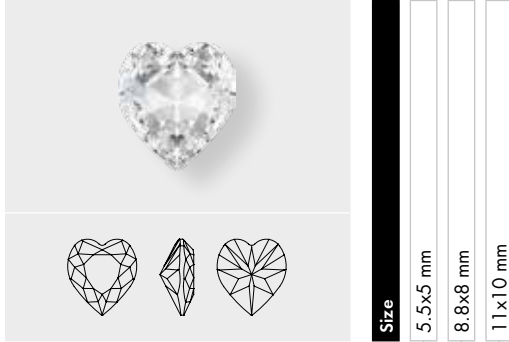

### Crystal

Crystal F (001)

### Colors

#### Plain Colors

Light Amethyst F (212)

Light Rose F (223)

Rosaline F (508)

Siam F (208)

Size

5.5x5 mm

8.8x8 mm

11x10 mm

## 4831/S



### Ring/Hole, Back Configuration

00 C = No ring/hole, closed

H2 O = 4 holes/2 each side, open



00 C



H2 O

Size

5.5x5 mm

8.8x8 mm

11x10 mm

## 4835 Mini Heart Fancy Stone

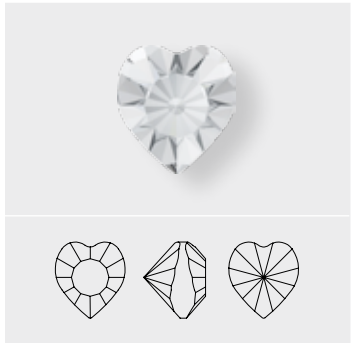

### Crystal

Crystal F (001)

Size

3.5 mm

# Fancy Stones & Settings

4841

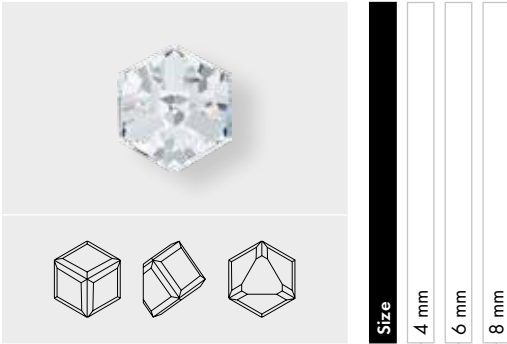

| Size | 4 mm | 6 mm | 8 mm |
|------|------|------|------|
|------|------|------|------|

**Crystal**

Crystal CAL VZ SI (001 CAL VZ SI)

**Colors**

**Plain Colors**

Aquamarine CAL VZ SI (202 CAL VZ SI)

Light Rose CAL VZ SI (223 CAL VZ SI)

Light Siam CAL VZ SI (227 CAL VZ SI)

Peridot CAL VZ SI (214 CAL VZ SI)

Violet CAL VZ SI (371 CAL VZ SI)

**Crystal Effects**

**Transparent Effects**

Crystal AB CAL VZ SI (001 AB CAL VZ SI)

Crystal Bermuda Blue Z (001 BBL Z)

Crystal Heliotrope Z (001 HEL Z)

Crystal Vitrail Light Z (001 VL Z)

Crystal Vitrail Medium Z (001 VM Z)

Crystal Golden Shadow CAL VZ SI (001 GSHA CAL VZ SI)

4869

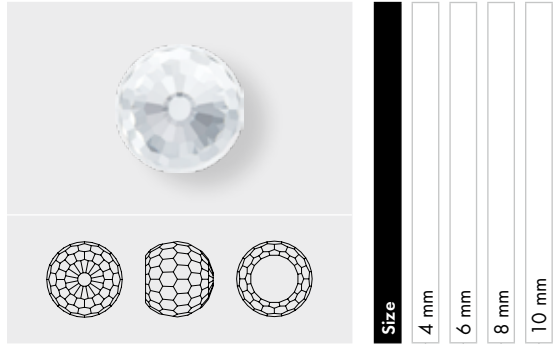

| Size | 4 mm | 6 mm | 8 mm | 10 mm |
|------|------|------|------|-------|
|------|------|------|------|-------|

**Crystal**

Crystal CAL VZ SI (001 CAL VZ SI)

**Colors**

**Plain Colors**

Aquamarine CAL VZ SI (202 CAL VZ SI)

Light Rose CAL VZ SI (223 CAL VZ SI)

Light Siam CAL VZ SI (227 CAL VZ SI)

Violet CAL VZ SI (371 CAL VZ SI)

**Crystal Effects**

**Transparent Effects**

Crystal AB CAL VZ SI (001 AB CAL VZ SI)

Crystal Vitrail Medium Z (001 VM Z)

# Fancy Stones & Settings

## 4884 XILION Heart Fancy Stone

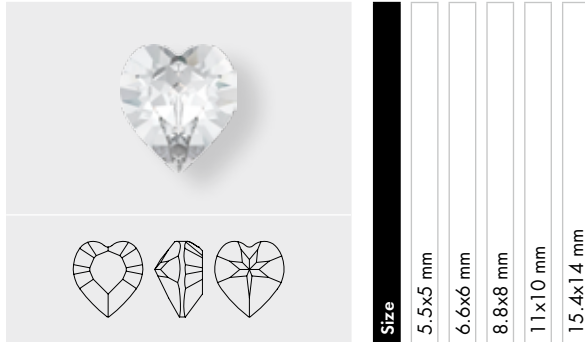

| Crystal                            | 5.5x5 mm | 6.6x6 mm | 8.8x8 mm | 11x10 mm | 15.4x14 mm |
|------------------------------------|----------|----------|----------|----------|------------|
| Crystal F (001)                    | ■        | ■        | ■        | ■        | ■          |
| Colors                             |          |          |          |          |            |
| Plain Colors                       |          |          |          |          |            |
| Amethyst F (204)                   | ■        | ■        | ■        | ■        | ■          |
| Aquamarine F (202)                 | ■        | ■        | ■        | ■        | ■          |
| Light Amethyst F (212)             | ■        | ■        | ■        | ■        | ■          |
| Light Rose F (223)                 | ■        | ■        | ■        | ■        | ■          |
| Light Siam F (227)                 | ■        | ■        | ■        | ■        | ■          |
| Montana F (207)                    | ■        | ■        | ■        | ■        | ■          |
| Peridot F (214)                    | ■        | ■        | ■        | ■        | ■          |
| Rose F (209)                       | ■        | ■        | ■        | ■        | ■          |
| Rose Peach F (262)                 | ■        | ■        | ■        | ■        | ■          |
| Crystal Effects                    |          |          |          |          |            |
| Transparent Effects                |          |          |          |          |            |
| Crystal AB F (001 AB)              | ■        | ■        | ■        | ■        | ■          |
| Crystal Antique Pink F (001 ANTP)  | ■        | ■        | ■        | ■        | ■          |
| Crystal Astral Pink F (001 API)    | ■        | ■        | ■        | ■        | ■          |
| Crystal Golden Shadow F (001 GSHA) | ■        | ■        | ■        | ■        | ■          |

## 4884/S



| Ring/Hole, Back Configuration    | 5.5x5 mm | 6.6x6 mm | 8.8x8 mm | 11x10 mm | 15.4x14 mm |
|----------------------------------|----------|----------|----------|----------|------------|
| 00 C = No ring/hole, closed      | ■        | ■        | ■        | ■        | ■          |
| H2 O = 4 holes/2 each side, open | ■        | ■        | ■        | ■        | ■          |

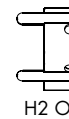



# Fancy Stones & Settings

## PRODUCT DETAILS

| Article Size  | Packing Unit = Minimum Order Quantity in Pieces | Average Net Weight in Gram per Packing Unit Crystal (001) | Average Gross Weight in Gram per Packing Unit Crystal (001) |
|---------------|---|---|---|
| <b>4120</b>   |   |   |   |
| 6x4 mm        | 360   | 31.2  | 42.1  |
| 8x6 mm        | 180   | 44.7  | 45.2  |
| 14x10 mm      | 144   | 170.2   | 193.8   |
| 18x13 mm      | 48  | 112.3   | 132.9   |
| 25x18 mm      | 24  | 152.2   | 177.6   |
| <b>4120/S</b> |   |   |   |
| 6x4 mm        | 360   |   | 43.3  |
| 8x6 mm        | 180   |   | 79.3  |
| 14x10 mm      | 144   |   | 86.0  |
| 18x13 mm      | 48  |   | 49.5  |
| 25x18 mm      | 24  |   | 48.8  |
| <b>4127</b>   |   |   |   |
| 30x22 mm      | 24  | 173.64  | 218.72  |
| 39x28 mm      | 12  | 226.8   | 246.4   |
| <b>4127/S</b> |   |   |   |
| 30x22 mm      | 24  |   | 53.0  |
| 39x28 mm      | 12  |   | 64.4  |
| <b>4128</b>   |   |   |   |
| 6x4 mm        | 360   | 26.8  | 37.6  |
| 8x6 mm        | 360   | 76.5  | 87.3  |
| 10x8 mm       | 144   | 59.9  | 80.2  |
| 14x10 mm      | 144   | 105.6   | 129.2   |
| <b>4128/S</b> |   |   |   |
| 6x4 mm        | 360   |   | 43.3  |
| 8x6 mm        | 360   |   | 79.3  |
| 10x8 mm       | 144   |   | 80.0  |
| 14x10 mm      | 144   |   | 86.0  |
| <b>4137</b>   |   |   |   |
| 15x11 mm      | 72  | 48.2  | 66.4  |
| 22x16 mm      | 24  | 44.2  | 64.2  |
| 33x24 mm      | 18  | 117.5   | 144.2   |
| <b>4139</b>   |   |   |   |
| 14 mm         | 72  | 53.2  | 82.7  |
| 20 mm         | 24  | 46.7  | 78.7  |
| 30 mm         | 18  | 124.6   | 153.0   |
| <b>4161</b>   |   |   |   |
| 15x5 mm       | 72  | 29.5  | 51.6  |
| 21x7 mm       | 48  | 71.5  | 96.5  |
| 27x9 mm       | 24  | 65.8  | 94.2  |
| <b>4161/S</b> |   |   |   |
| 15x5 mm       | 72  |   | 24.3  |
| 21x7 mm       | 48  |   | 27.0  |
| 27x9 mm       | 24  |   | 21.5  |
| <b>4196</b>   |   |   |   |
| 23x20 mm      | 16  | 113.2   | 141.2   |
| 30x26 mm      | 12  | 192.1   | 215.2   |
| <b>4196/S</b> |   |   |   |
| 23x20 mm      | 16  |   | 41.8  |
| 30x26 mm      | 12  |   | 49.1  |

# Fancy Stones & Settings

| Article Size  | Packing Unit = Minimum Order Quantity in Pieces | Average Net Weight in Gram per Packing Unit Crystal (001) | Average Gross Weight in Gram per Packing Unit Crystal (001) |
|---------------|---|---|---|
| <b>4200</b>   |   |   |   |
| 11x3 mm       | 360   | 28.6  | 39.4  |
| 15x4 mm       | 144   | 26.2  | 37.1  |
| 35x9.5 mm     | 16  | 41.9  | 63.8  |
| 48x13 mm      | 6   | 38.3  | 70.8  |
| <b>4200/S</b> |   |   |   |
| 11x3 mm       | 360   |   | 64.9  |
| 15x4 mm       | 144   |   | 39.7  |
| 35x9.5 mm     | 16  |   | 34.1  |
| 48x13 mm      | 6   |   | 23.6  |
| <b>4224</b>   |   |   |   |
| 10x8 mm       | 144   | 51.4  | 63.3  |
| 14x11 mm      | 72  | 53.2  | 72.3  |
| 23x18 mm      | 36  | 59.8  | 79.4  |
| <b>4224/S</b> |   |   |   |
| 10x8 mm       | 144   |   | 62.7  |
| 14x11 mm      | 72  |   | 55.5  |
| 23x18 mm      | 36  |   | 41.5  |
| <b>4227</b>   |   |   |   |
| 32x17 mm      | 24  | 100.8   | 123.4   |
| <b>4227/S</b> |   |   |   |
| 32x17 mm      | 24  |   | 48.0  |
| <b>4228</b>   |   |   |   |
| 4x2 mm        | 720   | 9.2   | 18.3  |
| 5x2.5 mm      | 720   | 18.9  | 28.0  |
| 6x3 mm        | 720   | 30.5  | 39.6  |
| 8x4 mm        | 360   | 32.9  | 42.0  |
| 10x5 mm       | 360   | 60.7  | 72.1  |
| 15x7 mm       | 144   | 63.9  | 88.1  |
| <b>4228/S</b> |   |   |   |
| 5x2.5 mm      | 720   |   | 46.9  |
| 6x3 mm        | 720   |   | 75.7  |
| 8x4 mm        | 360   |   | 50.5  |
| 10x5 mm       | 360   |   | 82.9  |
| 15x7 mm       | 144   |   | 85.8  |
| <b>4230</b>   |   |   |   |
| 14x9 mm       | 144   | 75.116  | 98.824  |
| 19x12 mm      | 72  | 86.486  | 113.884   |
| 23x15 mm      | 48  | 102.816   | 122.976   |
| <b>4230/S</b> |   |   |   |
| 14x9 mm       | 144   |   | 57.6  |
| 19x12 mm      | 72  |   | 72.0  |
| 23x15 mm      | 48  |   | 72.0  |
| <b>4320</b>   |   |   |   |
| 6x4 mm        | 360   | 25.7  | 34.8  |
| 8x6 mm        | 180   | 30.7  | 39.8  |
| 10x7 mm       | 144   | 48.6  | 68.9  |
| 14x10 mm      | 144   | 126.6   | 150.2   |
| 18x13 mm      | 48  | 85.2  | 105.8   |
| <b>4320/S</b> |   |   |   |
| 6x4 mm        | 360   |   | 43.3  |
| 8x6 mm        | 180   |   | 39.7  |
| 10x7 mm       | 144   |   | 71.4  |
| 14x10 mm      | 144   |   | 126.1   |
| 18x13 mm      | 48  |   | 54.6  |

# Fancy Stones & Settings

| Article Size  | Packing Unit = Minimum Order Quantity in Pieces | Average Net Weight in Gram per Packing Unit Crystal (001) | Average Gross Weight in Gram per Packing Unit Crystal (001) |
|---------------|---|---|---|
| <b>4327</b>   |   |   |   |
| 30x20 mm      | 24  | 161.8   | 206.8   |
| 40x27 mm      | 12  | 201.6   | 226.3   |
| <b>4327/S</b> |   |   |   |
| 30x20 mm      | 24  |   | 51.5  |
| 40x27 mm      | 12  |   | 63.7  |
| <b>4328</b>   |   |   |   |
| 6x3.6 mm      | 720   | 40.0  | 50.5  |
| 8x4.8 mm      | 360   | 42.1  | 53.0  |
| 10x6 mm       | 144   | 29.2  | 50.5  |
| 13x7.8 mm     | 144   | 65.1  | 88.3  |
| <b>4328/S</b> |   |   |   |
| 6x3.6 mm      | 720   |   | 79.4  |
| 8x4.8 mm      | 360   |   | 54.1  |
| 10x6 mm       | 144   |   | 33.9  |
| 13x7.8 mm     | 144   |   | 51.2  |
| <b>4370</b>   |   |   |   |
| 11x10 mm      | 144   | 82.8  | 100.9   |
| 15.5x14 mm    | 72  | 107.3   | 127.4   |
| 20x18 mm      | 48  | 149.5   | 170.0   |
| <b>4370/S</b> |   |   |   |
| 11x10 mm      | 144   |   | 78.6  |
| 15.5x14 mm    | 72  |   | 75.0  |
| 20x18 mm      | 48  |   | 77.1  |
| <b>4418</b>   |   |   |   |
| 6 mm          | 216   | 55.35   | 79.20   |
| 8 mm          | 216   | 119.93  | 147.84  |
| <b>4418/S</b> |   |   |   |
| 6 mm          | 216   |   | 54.0  |
| 8 mm          | 216   |   | 138.2   |
| <b>4428</b>   |   |   |   |
| 1.5 mm        | 1,440   | 4.32  | 15.1  |
| 2 mm          | 1,440   | 12.2  | 23.0  |
| 3 mm          | 1,440   | 34.8  | 57.6  |
| 4 mm          | 1,440   | 108.5   | 119.5   |
| 5 mm          | 360   | 51.6  | 61.9  |
| 6 mm          | 360   | 88.55   | 93.0  |
| 8 mm          | 144   | 84.5  | 99.6  |
| <b>4428/S</b> |   |   |   |
| 4 mm          | 1,440   |   | 104.5   |
| 5 mm          | 360   |   | 58.0  |
| 6 mm          | 360   |   | 50.0  |
| 8 mm          | 144   |   | 45.5  |
| <b>4439</b>   |   |   |   |
| 14 mm         | 72  | 88.0  | 111.6   |
| 20 mm         | 24  | 80.4  | 123.0   |
| 30 mm         | 12  | 127.6   | 145.8   |

# Fancy Stones & Settings

| Article Size  | Packing Unit = Minimum Order Quantity in Pieces | Average Net Weight in Gram per Packing Unit Crystal (001) | Average Gross Weight in Gram per Packing Unit Crystal (001) |
|---------------|---|---|---|
| <b>4447</b>   |   |   |   |
| 6 mm          | 360   | 87.5  | 98.3  |
| 8 mm          | 144   | 71.5  | 91.9  |
| 10 mm         | 144   | 133.9   | 157.2   |
| 12 mm         | 72  | 117.6   | 137.9   |
| <b>4447/S</b> |   |   |   |
| 6 mm          | 360   |   | 50.0  |
| 8 mm          | 144   |   | 47.0  |
| 10 mm         | 144   |   | 70.5  |
| 12 mm         | 72  |   | 56.0  |
| <b>4461</b>   |   |   |   |
| 8 mm          | 144   | 56.9  | 77.2  |
| 12 mm         | 72  | 84.4  | 103.4   |
| 16 mm         | 72  | 214.4   | 238.0   |
| <b>4461/S</b> |   |   |   |
| 8 mm          | 144   |   | 62.7  |
| 12 mm         | 72  |   | 52.8  |
| 16 mm         | 72  |   | 92.0  |
| <b>4470</b>   |   |   |   |
| 10 mm         | 144   | 91.6  | 111.9   |
| 12 mm         | 72  | 74.7  | 92.9  |
| 18 mm         | 48  | 170.3   | 190.9   |
| <b>4470/S</b> |   |   |   |
| 10 mm         | 144   |   | 54.5  |
| 12 mm         | 72  |   | 53.3  |
| 18 mm         | 48  |   | 92.0  |
| <b>4500</b>   |   |   |   |
| 3x2 mm        | 1,440   | 20.5  | 32.0  |
| 6x2 mm        | 720   | 18.4  | 27.5  |
| 10x3 mm       | 360   | 36.6  | 47.6  |
| <b>4500/S</b> |   |   |   |
| 6x2 mm        | 720   |   | 61.3  |
| 10x3 mm       | 360   |   | 68.5  |
| <b>4501</b>   |   |   |   |
| 4x2 mm        | 720   | 16.8  | 25.9  |
| 5x2 mm        | 720   | 18.1  | 27.2  |
| 5x2.5 mm      | 720   | 20.9  | 30.0  |
| 7x3 mm        | 720   | 60.2  | 71.1  |
| 10x5 mm       | 360   | 96.2  | 106.9   |
| <b>4501/S</b> |   |   |   |
| 5x2.5 mm      | 720   |   | 61.3  |
| 7x3 mm        | 720   |   | 58.0  |
| 10x5 mm       | 360   |   | 147.7   |
| <b>4502</b>   |   |   |   |
| 3x1 mm        | 720   | 2.2   | 11.4  |
| <b>4505</b>   |   |   |   |
| 8x5 mm        | 240   | 44.2  | 55.0  |
| 10x6 mm       | 144   | 52.6  | 73.7  |
| 14x8 mm       | 108   | 103.4   | 120   |
| <b>4505/S</b> |   |   |   |
| 8x5 mm        | 240   |   | 54.1  |
| 10x6 mm       | 144   |   | 72.8  |
| 14x8 mm       | 108   |   | 91.1  |

# Fancy Stones & Settings

| Article Size  | Packing Unit = Minimum Order Quantity in Pieces | Average Net Weight in Gram per Packing Unit Crystal (001) | Average Gross Weight in Gram per Packing Unit Crystal (001) |
|---------------|---|---|---|
| <b>4524</b>   |   |   |   |
| 12x6 mm       | 144   | 67.7  | 89.4  |
| 16x8 mm       | 72  | 78.0  | 102.7   |
| 23x11 mm      | 36  | 104.0   | 131.9   |
| <b>4524/S</b> |   |   |   |
| 12x6 mm       | 144   |   | 77.1  |
| 16x8 mm       | 72  |   | 64.9  |
| 23x11 mm      | 36  |   | 60.6  |
| <b>4527</b>   |   |   |   |
| 8x6 mm        | 144   | 53.7  | 64.57   |
| 14x10 mm      | 72  | 122.4   | 144.9   |
| 18x13 mm      | 72  | 246.9   | 270.6   |
| <b>4527/S</b> |   |   |   |
| 8x6 mm        | 144   |   | 45.5  |
| 14x10 mm      | 72  |   | 60.3  |
| 18x13 mm      | 72  |   | 104.5   |
| <b>4547</b>   |   |   |   |
| 15x5 mm       | 72  | 37.4  | 58.9  |
| 21x7 mm       | 48  | 65.3  | 98.7  |
| 24x8 mm       | 48  | 97.4  | 130.5   |
| 30x10 mm      | 24  | 101.0   | 124.4   |
| <b>4547/S</b> |   |   |   |
| 15x5 mm       | 72  |   | 36.8  |
| 21x7 mm       | 48  |   | 43.5  |
| 24x8 mm       | 48  |   | 50.5  |
| 30x10 mm      | 24  |   | 39.0  |
| <b>4565</b>   |   |   |   |
| 14x10 mm      | 72  | 71.5  | 88.9  |
| 18x13 mm      | 48  | 101.2   | 121.8   |
| <b>4565/S</b> |   |   |   |
| 14x10 mm      | 72  |   | 64.2  |
| 18x13 mm      | 48  |   | 69.9  |
| <b>4568</b>   |   |   |   |
| 8x6 mm        | 144   | 34.70   | 55.79   |
| 14x10 mm      | 72  | 74.87   | 103.12  |
| 18x13 mm      | 24  | 46.17   | 64.73   |
| 27x18 mm      | 20  | 105.84  | 132.70  |
| <b>4568/S</b> |   |   |   |
| 8x6 mm        | 144   |   | 36.7  |
| 14x10 mm      | 72  |   | 54.0  |
| 18x13 mm      | 24  |   | 37.2  |
| 27x18 mm      | 20  |   | 61.0  |
| <b>4600</b>   |   |   |   |
| 6x4 mm        | 360   | 40.9  | 51.8  |
| 8x6 mm        | 144   | 41.2  | 52.2  |
| 10x8 mm       | 144   | 84.0  | 104.0   |
| 12x10 mm      | 144   | 146.7   | 170.3   |
| <b>4600/S</b> |   |   |   |
| 6x4 mm        | 360   |   | 46.9  |
| 8x6 mm        | 144   |   | 39.7  |
| 10x8 mm       | 144   |   | 90.1  |
| 12x10 mm      | 144   |   | 127.5   |

# Fancy Stones & Settings

| Article Size  | Packing Unit = Minimum Order Quantity in Pieces | Average Net Weight in Gram per Packing Unit Crystal (001) | Average Gross Weight in Gram per Packing Unit Crystal (001) |
|---------------|---|---|---|
| <b>4610</b>   |   |   |   |
| 14x10 mm      | 144   | 171.3   | 194.9   |
| 18x13 mm      | 48  | 124.9   | 145.5   |
| 20x15 mm      | 24  | 88.5  | 105.8   |
| <b>4610/S</b> |   |   |   |
| 14x10 mm      | 144   |   | 104.5   |
| 18x13 mm      | 48  |   | 66.0  |
| 20x15 mm      | 24  |   | 51.0  |
| <b>4627</b>   |   |   |   |
| 27x18.5 mm    | 24  | 125.3   | 170.8   |
| 37x25.5 mm    | 12  | 170.7   | 197.8   |
| <b>4627/S</b> |   |   |   |
| 27x18.5 mm    | 24  |   | 54.0  |
| 37x25.5 mm    | 12  |   | 60.1  |
| <b>4675</b>   |   |   |   |
| 23 mm         | 24  | 175.4   | 220.5   |
| <b>4675/S</b> |   |   |   |
| 23 mm         | 24  |   | 73.8  |
| <b>4678</b>   |   |   |   |
| 8 mm          | 144   | 42.407  | 51.555  |
| 14 mm         | 48  | 81.325  | 102.655   |
| 23 mm         | 16  | 98.784  | 121.309   |
| <b>4678/G</b> |   |   |   |
| 8 mm          | 144   | 42.407  | 51.555  |
| 14 mm         | 48  | 81.325  | 102.655   |
| 23 mm         | 16  | 98.784  | 121.309   |
| <b>4678/S</b> |   |   |   |
| 8 mm          | 144   |   | 37.4  |
| 14 mm         | 48  |   | 38.4  |
| 23 mm         | 16  |   | 49.6  |
| <b>4706</b>   |   |   |   |
| 7 mm          | 144   | 23.714  | 44.378  |
| 12 mm         | 72  | 61.508  | 83.886  |
| 17 mm         | 48  | 96.365  | 119.791   |
| 24 mm         | 16  | 109.066   | 145.716   |
| <b>4706/S</b> |   |   |   |
| 7 mm          | 144   |   | 28.8  |
| 12 mm         | 72  |   | 36.0  |
| 17 mm         | 48  |   | 81.6  |
| 24 mm         | 16  |   | 48.0  |
| <b>4717</b>   |   |   |   |
| 15.5 mm       | 72  | 139.9   | 148.3   |
| 21.5 mm       | 32  | 152.8   | 161.8   |
| <b>4717/S</b> |   |   |   |
| 15.5 mm       | 72  |   | 86.0  |
| 21.5 mm       | 32  |   | 54.0  |
| <b>4722</b>   |   |   |   |
| 4 mm          | 480   | 12.0  | 21.1  |
| 6 mm          | 180   | 16.4  | 25.5  |
| 8 mm          | 144   | 29.0  | 48.1  |
| 10 mm         | 144   | 61.4  | 84.4  |
| <b>4722/S</b> |   |   |   |
| 4 mm          | 480   |   | 46.9  |
| 6 mm          | 180   |   | 30.7  |
| 8 mm          | 144   |   | 45.1  |
| 10 mm         | 144   |   | 74.3  |

# Fancy Stones & Settings

| Article Size  | Packing Unit = Minimum Order Quantity in Pieces | Average Net Weight in Gram per Packing Unit Crystal (001) | Average Gross Weight in Gram per Packing Unit Crystal (001) |
|---------------|---|---|---|
| <b>4727</b>   |   |   |   |
| 23 mm         | 24  | 131.8   | 176.8   |
| <b>4727/S</b> |   |   |   |
| 23 mm         | 24  |   | 41.0  |
| <b>4739</b>   |   |   |   |
| 14x11 mm      | 144   | 143.7   | 170.4   |
| 20x16 mm      | 72  | 200.7   | 229.8   |
| <b>4739/S</b> |   |   |   |
| 14x11 mm      | 144   |   | 117.5   |
| 20x16 mm      | 72  |   | 112.3   |
| <b>4744</b>   |   |   |   |
| 6 mm          | 720   | 62.3  | 72.8  |
| 10 mm         | 288   | 126.0   | 158.1   |
| <b>4744/S</b> |   |   |   |
| 6 mm          | 720   |   | 104.5   |
| 10 mm         | 288   |   | 93.0  |
| <b>4745</b>   |   |   |   |
| 5 mm          | 720   | 35.6  | 46.4  |
| 10 mm         | 144   | 48.5  | 71.3  |
| <b>4745/S</b> |   |   |   |
| 5 mm          | 720   |   | 68.5  |
| 10 mm         | 144   |   | 43.0  |
| <b>4747</b>   |   |   |   |
| 5 mm          | 720   | 40.0  | 49.7  |
| <b>4747/S</b> |   |   |   |
| 5 mm          | 720   |   | 68.5  |
| <b>4748</b>   |   |   |   |
| 5 mm          | 720   | 72.0  | 80.6  |
| 10 mm         | 288   | 195.8   | 241.9   |
| <b>4748/S</b> |   |   |   |
| 5 mm          | 720   |   | 90.1  |
| 10 mm         | 288   |   | 162.1   |
| <b>4756</b>   |   |   |   |
| 19x11.5 mm    | 96  | 112.5   | 171.3   |
| 27x16 mm      | 40  | 152.0   | 194.0   |
| 39x23.5 mm    | 24  | 264.0   | 229.2   |
| <b>4756/S</b> |   |   |   |
| 19x11.5 mm    | 96  |   | 84.3  |
| 27x16 mm      | 40  |   | 66.1  |
| 39x23.5 mm    | 24  |   | 72.3  |
| <b>4757</b>   |   |   |   |
| 14x8.5 mm     | 96  | 82.6  | 104.8   |
| 19x11.5 mm    | 96  | 182.4   | 211.6   |
| <b>4757/S</b> |   |   |   |
| 14x8.5 mm     | 96  |   | 65.2  |
| 19x11.5 mm    | 96  |   | 125.6   |
| <b>4760</b>   |   |   |   |
| 14x8 mm       | 144   | 132.6   | 145.8   |
| 18x10.5 mm    | 96  | 168.7   | 204.7   |
| 22x12.5 mm    | 36  | 126.6   | 154.2   |
| <b>4760/S</b> |   |   |   |
| 14x8 mm       | 144   |   | 105.1   |
| 18x10.5 mm    | 96  |   | 107.0   |
| 22x12.5 mm    | 36  |   | 59.4  |

# Fancy Stones & Settings

| Article Size  | Packing Unit = Minimum Order Quantity in Pieces | Average Net Weight in Gram per Packing Unit Crystal (001) | Average Gross Weight in Gram per Packing Unit Crystal (001) |
|---------------|---|---|---|
| <b>4773</b>   |   |   |   |
| 14x7.5 mm     | 72  | 43.122  | 64.774  |
| 18x9.5 mm     | 48  | 56.448  | 78.503  |
| 28x15 mm      | 20  | 90.720  | 111.115   |
| <b>4773/S</b> |   |   |   |
| 14x7.5 mm     | 72  |   | 28.8  |
| 18x9.5 mm     | 48  |   | 48.0  |
| 28x15 mm      | 20  |   | 41.2  |
| <b>4789</b>   |   |   |   |
| 14 mm         | 72  | 100.8   | 129.2   |
| 23 mm         | 32  | 188.8   | 225.6   |
| 29 mm         | 18  | 214.2   | 242.9   |
| <b>4789/S</b> |   |   |   |
| 14 mm         | 72  |   | 60.6  |
| 23 mm         | 32  |   | 70.9  |
| 29 mm         | 18  |   | 62.0  |
| <b>4790</b>   |   |   |   |
| 18x7.5 mm     | 108   | 72.3  | 97.1  |
| 23x10 mm      | 36  | 48.2  | 71.9  |
| 32x13.5 mm    | 30  | 105.5   | 139.5   |
| <b>4790/S</b> |   |   |   |
| 18x7.5 mm     | 108   |   | 85.9  |
| 23x10 mm      | 36  |   | 47.7  |
| 32x13.5 mm    | 30  |   | 75.5  |
| <b>4795</b>   |   |   |   |
| 14 mm         | 72  | 72.0  | 106.92  |
| 19 mm         | 48  | 124.8   | 152.5   |
| 28 mm         | 24  | 204.0   | 254.8   |
| <b>4795/S</b> |   |   |   |
| 14 mm         | 72  |   | 63.5  |
| 19 mm         | 48  |   | 80.5  |
| 28 mm         | 24  |   | 78.1  |
| <b>4809</b>   |   |   |   |
| 13x12 mm      | 72  | 47.779  | 68.463  |
| 17x15.5 mm    | 48  | 63.302  | 84.793  |
| 27x25 mm      | 16  | 86.312  | 100.020   |
| <b>4809/S</b> |   |   |   |
| 13x12 mm      | 72  |   | 36.0  |
| 17x15.5 mm    | 48  |   | 48.0  |
| 27x25 mm      | 16  |   | 28.8  |
| <b>4810</b>   |   |   |   |
| 13x12 mm      | 72  | 48.384  | 69.068  |
| <b>4810/S</b> |   |   |   |
| 13x12 mm      | 72  |   | 36.0  |
| <b>4827</b>   |   |   |   |
| 28 mm         | 24  | 214.9   | 253.3   |
| <b>4827/S</b> |   |   |   |
| 28 mm         | 24  |   | 55.5  |



# Fancy Stones & Settings

| Article Size  | Packing Unit = Minimum Order Quantity in Pieces | Average Net Weight in Gram per Packing Unit Crystal (001) | Average Gross Weight in Gram per Packing Unit Crystal (001) |
|---------------|---|---|---|
| <b>4831</b>   |   |   |   |
| 5.5x5 mm      | 360   | 26.5  | 37.3  |
| 8.8x8 mm      | 144   | 40.0  | 60.4  |
| 11x10 mm      | 144   | 80.1  | 101.5   |
| <b>4831/S</b> |   |   |   |
| 5.5x5 mm      | 360   |   | 54.1  |
| 8.8x8 mm      | 144   |   | 46.9  |
| 11x10 mm      | 144   |   | 97.3  |
| <b>4835</b>   |   |   |   |
| 3.5 mm        | 1,440   | 48.2  | 54.0  |
| <b>4841</b>   |   |   |   |
| 4 mm          | 288   | 45.3  | 66.6  |
| 6 mm          | 144   | 77.2  | 95.3  |
| 8 mm          | 72  | 89.2  | 107.4   |
| <b>4869</b>   |   |   |   |
| 4 mm          | 480   | 36.2  | 45.3  |
| 6 mm          | 180   | 47.2  | 56.4  |
| 8 mm          | 144   | 90.8  | 109.0   |
| 10 mm         | 72  | 88.3  | 105.3   |
| <b>4884</b>   |   |   |   |
| 5.5x5 mm      | 360   | 39.0  | 49.7  |
| 6.6x6 mm      | 360   | 67.2  | 78.0  |
| 8.8x8 mm      | 288   | 111.4   | 138.1   |
| 11x10 mm      | 144   | 107.3   | 127.4   |
| 15.4x14 mm    | 72  | 128.7   | 149.3   |
| <b>4884/S</b> |   |   |   |
| 5.5x5 mm      | 360   |   | 54.1  |
| 6.6x6 mm      | 360   |   | 72.1  |
| 8.8x8 mm      | 288   |   | 46.9  |
| 11x10 mm      | 144   |   | 101.6   |
| 15.4x14 mm    | 72  |   | 103.1   |

