

Beads

Beads offer the highest standard available on the market. The high-quality precision cutting and the clear through-hole achieve high brilliance and clarity. Rounded hole edges reduce the wear on thread and increase the durability of designs. The assortment is divided into classic, romantic, and progressive shape characteristics. They are available in the latest fashion colors, effects, and cuts. A wide range of colors and effects opens up endless possibilities for different combinations and designs. The main application techniques are beading, wiring, stringing, and weaving. Crystal Mesh Balls are also part of this product group.

COLORS & EFFECTS

Colors

	Provence Lavender 283
	Light Sapphire 211
	Light Azure 361
	Aquamarine 202
	Air Blue Opal 285
	Sapphire 206
	Capri Blue 243
	Dark Indigo 288
	Montana 207
	Turquoise 267
	Caribbean Blue Opal 394
	Light Turquoise 263
	Blue Zircon 229
	Indicolite 379
	Indian Sapphire 217
	Denim Blue 266
	Black Diamond 215
	Pacific Opal 390
	Chrysolite Opal 294
	Chrysolite 238
	Peridot 214
	Erinite 360
	Fern Green 291
	Dark Moss Green 260
	Emerald 205
	Palace Green Opal 393
	Olivine 228
	Khaki 550
	Greige 284
	Light Grey Opal 383

	Sand Opal 287
	Light Colorado Topaz 246
	Jonquil 213
	Citrine 249
	Light Topaz 226
	Sunflower 292
	Topaz 203
	Tangerine 259
	Light Smoked Topaz 221
	Smoked Topaz 220
	Smoky Quartz 225
	Mocca 286
	Jet 280

Crystal Blend Colors

	Amethyst Blend 721
	Provence Lavender-Chrysolite Blend 726
	Crystal-Montana Blend 725
	Burgundy-Blue Zircon Blend 723
	Fern Green-Topaz Blend 724
	Topaz Blend 722

Effects

	Crystal Silver Shade 001 SSHA
	Crystal Moonlight 001 MOL
	Crystal Aurore Boreale 001 AB
	Crystal Aurore Boreale 2x 001 AB2
	Crystal Aurore Boreale Satin 001 ABSAT
	Crystal Luminous Green** 001 LUMG
	Crystal Golden Shadow** 001 GSHA





























	Crystal Rose Gold 001 ROGL
	Crystal Rose Gold 2x 001 ROGL2
	Crystal Copper** 001 COP
	Crystal Astral Pink 001 API
	Crystal Red Magma** 001 REDM
	Crystal Antique Pink 001 ANTP
	Crystal Vitrail Light** 001 VL
	Crystal Vitrail Medium** 001 VM
	Crystal Lilac Shadow 001 LISH
	Crystal Heliotrope** 001 HEL
	Crystal Bermuda Blue** 001 BBL
	Crystal Metallic Blue 2x** 001 METBL2
	Crystal Blue Shade** 001 BLSH

	Crystal Tabac 001 TAB
	Crystal Iridescent Green 001 IRIG
	Crystal Dorado 2x** 001 DOR2
	Crystal Metallic Light Gold 2x** 001 MLGLD2
	Crystal Bronze Shade** 001 BRSH
	Crystal Satin** 001 SAT
	Crystal Comet Argent Light** 001 CAL
	Crystal Silver Night** 001 SINI

	Jet Nut 2x** 280 NUT2
	Jet Hematite** 280 HEM
	Jet Hematite 2x** 280 HEM2

Full Coating

	Crystal Comet Argent Light FC** 001 CAL FC
	Crystal Aurore Boreale FC 001 AB FC
	White Opal AB FC 234 AB FC
	Light Rose AB FC 223 AB FC

	Rose AB FC 209 AB FC
	Violet AB FC 371 AB FC
	Light Amethyst AB FC 212 AB FC
	Light Siam AB FC 227 AB FC
	Crystal Astral Pink FC 001 API FC
	Padparadscha AB FC 542 AB FC
	Emerald AB FC 205 AB FC
	Montana AB FC 207 AB FC
	Indian Sapphire AB FC 217 AB FC
	Indicolite AB FC 379 AB FC
	Capri Blue AB FC 243 AB FC
	Aquamarine AB FC 202 AB FC
	Tanzanite AB FC 539 AB FC
	Sapphire AB FC 206 AB FC
	Turquoise AB FC 267 AB FC
	Fuchsia AB FC 502 AB FC
	Peridot AB FC 214 AB FC
	Chrysolite AB FC 238 AB FC
	Jonquil AB FC 213 AB FC
	Light Colorado Topaz AB FC 246 AB FC
	Topaz AB FC 203 AB FC
	Jet AB FC 280 AB FC
	Black Diamond AB FC 215 AB FC
	Siam AB FC 208 AB FC
	Amethyst AB FC 204 AB FC
	Crystal Iridescent Green FC 001 IRIG FC
	Crystal Bronze Shade FC** 001 BRSH FC
	Crystal Metallic Blue FC* 001 METBL FC
	Jet Hematite FC 280 HEM FC

Numerical Order

001	Crystal	202	Aquamarine	234	White Opal	292	Sunflower
001 AB	Crystal Aurore Boreale	202 AB FC	Aquamarine AB FC	234 AB FC	White Opal AB FC	294	Chrysolite Opal
001 AB2	Crystal Aurore Boreale 2x	203	Topaz	236	Hyacinth	319	Vintage Rose
001 ABSAT	Crystal Aurore Boreale Satin	203 AB FC	Topaz AB FC	237	Fireopal	360	Erinite
001 AB FC	Crystal Aurore Boreale FC	204	Amethyst	238	Chrysolite	361	Light Azore
001 ANTP	Crystal Antique Pink	204 AB FC	Amethyst AB FC	238 AB FC	Chrysolite AB FC	362	Light Peach
001 API	Crystal Astral Pink	205 AB FC	Emerald AB FC	241	Garnet	371	Violet
001 API FC	Crystal Astral Pink FC	205	Emerald	243	Capri Blue	371 AB FC	Violet AB FC
001 BBL	Crystal Bermuda Blue	206	Sapphire	243 AB FC	Capri Blue AB FC	379	Indicolite
001 BLSH	Crystal Blue Shade**	206 AB FC	Sapphire AB FC	246	Light Colorado Topaz	379 AB FC	Indicolite AB FC
001 BRSH	Crystal Bronze Shade**	207	Montana	246 AB FC	Light Colorado Topaz AB FC	383	Light Grey Opal
001 BRSH FC	Crystal Bronze Shade FC**	207 AB FC	Montana AB FC	248	Sun	390	Pacific Opal
001 CAL	Crystal Comet Argent Light**	208	Siam	249	Citrine	391	Silk
001 CAL FC	Crystal Comet Argent Light FC**	208 AB FC	Siam AB FC	259	Tangerine	393	Palace Green Opal
001 COP	Crystal Copper**	209	Rose	260	Dark Moss Green	394	Caribbean Blue Opal
001 DOR2	Crystal Dorado 2x**	209 AB FC	Rose AB FC	261	Light Silk	395	Rose Water Opal
001 GSHA	Crystal Golden Shadow**	211	Light Sapphire	262	Rose Peach	398	Cyclamen Opal
001 HEL	Crystal Heliotrope**	212	Light Amethyst	263	Light Turquoise	501	Ruby
001 IRIG	Crystal Iridescent Green	212 AB FC	Light Amethyst AB FC	266	Denim Blue	502	Fuchsia
001 IRIG FC	Crystal Iridescent Green FC	213	Jonquil	267	Turquoise	502 AB FC	Fuchsia AB FC
001 IISH	Crystal Lilac Shadow	213 AB FC	Jonquil AB FC	267 AB FC	Turquoise AB FC	508	Rosaline
001 LUMG	Crystal Luminous Green**	214	Peridot	277	Purple Velvet	515	Burgundy
001 METBL2	Crystal Metallic Blue 2x**	214 AB FC	Peridot AB FC	280	Jet	539	Tanzanite
001 METBL2 FC	Crystal Metallic Blue FC*	215 AB FC	Black Diamond AB FC	280 AB FC	Jet AB FC	539 AB FC	Tanzanite AB FC
001 MLGLD2	Crystal Metallic Light Gold 2x**	215	Black Diamond	280 HEM	Jet Hematite**	542	Padparadscha
001 MOL	Crystal Moonlight	217	Indian Sapphire	280 HEM2	Jet Hematite 2x**	542 AB FC	Padparadscha AB FC
001 REDM	Crystal Red Magma**	217 AB FC	Indian Sapphire AB FC	280 HEM FC	Jet Hematite FC	550	Khaki
001 ROGL	Crystal Rose Gold	220	Smoked Topaz	280 NUT2	Jet Nut 2x**	721	Amethyst Blend
001 ROGL2	Crystal Rose Gold 2x	221	Light Smoked Topaz	281	White Alabaster	722	Topaz Blend
001 SAT	Crystal Satin**	223	Light Rose	283	Provence Lavender	723	Burgundy-Blue
001 SINI	Crystal Silver Night**	223 AB FC	Light Rose AB FC	284	Greige	724	Zircon Blend
001 SSHA	Crystal Silver Shade**	225	Smoky Quartz	285	Air Blue Opal	725	Fern Green
001 TAB	Crystal Tabac**	226	Light Topaz	286	Mocca	726	Topaz Blend
001 VL	Crystal Vitrail Light**	227	Light Siam	287	Sand Opal		Crystal-Montana Blend
001 VM	Crystal Vitrail Medium	227 AB FC	Light Siam AB FC	288	Dark Indigo		Provence Lavender
		228	Olivine	289	Indian Pink		Chrysolite Blend
		229	Blue Zircon	291	Fern Green		

Alphabetical Order

Air Blue Opal (285)	Crystal Iridescent Green (001 IRIG)	Indicolite (379)	Peridot AB FC (214 AB FC)
Amethyst (204)	Crystal Iridescent Green FC (001 IRIG FC)	Indicolite AB FC (379 AB FC)	Provence Lavender (283)
Amethyst AB FC (204 AB FC)	Crystal Lilac Shadow (001 IISH)	Jet (280)	Provence Lavender-Chrysolite Blend (726)
Amethyst Blend (721)	Crystal Luminous Green** (001 LUMG)	Jet AB FC (280 AB FC)	Purple Velvet (277)
Aquamarine (202)	Crystal Metallic Blue 2x** (001 METBL2)	Jet Hematite** (280 HEM)	Rosaline (508)
Aquamarine AB FC (202 AB FC)	Crystal Metallic Blue FC* (001 METBL2 FC)	Jet Hematite 2x** (280 HEM2)	Rose (209)
Black Diamond (215)	Crystal Metallic Light Gold 2x** (001 MLGLD2)	Jet Hematite FC (280 HEM FC)	Rose AB FC (209 AB FC)
Black Diamond AB FC (215 AB FC)	Crystal-Montana Blend (725)	Jet Nut 2x** (280 NUT2)	Rose Peach (262)
Blue Zircon (229)	Crystal Moonlight (001 MOL)	Jonquil (213)	Rose Water Opal (395)
Burgundy (515)	Crystal Red Magma** (001 REDM)	Jonquil AB FC (213 AB FC)	Ruby (501)
Burgundy-Blue Zircon Blend (723)	Crystal Rose Gold (001 ROGL)	Khaki (550)	Sand Opal (287)
Capri Blue (243)	Crystal Rose Gold 2x (001 ROGL2)	Light Amethyst (212)	Sapphire (206)
Capri Blue AB FC (243 AB FC)	Crystal Satin** (001 SAT)	Light Amethyst AB FC (212 AB FC)	Sapphire AB FC (206 AB FC)
Caribbean Blue Opal (394)	Crystal Silver Night** (001 SINI)	Light Azore (361)	Siam (208)
Chrysolite (238)	Crystal Silver Shade (001 SSHA)	Light Colorado Topaz (246)	Siam AB FC (208 AB FC)
Chrysolite AB FC (238 AB FC)	Crystal Silver Shade** (001 SSHA)	Light Colorado Topaz AB FC (246 AB FC)	Silk (391)
Chrysolite Opal (294)	Crystal Tabac** (001 TAB)	Light Colorado Topaz AB FC (246 AB FC)	Smoked Topaz (220)
Citrine (249)	Crystal Vitrail Light** (001 VL)	Light Grey Opal (383)	Smoky Quartz (225)
Crystal (001)	Crystal Vitrail Medium** (001 VM)	Light Peach (362)	Sun (248)
Crystal Antique Pink (001 ANTP)	Cyclamen Opal (398)	Light Rose (223)	Sunflower (292)
Crystal Astral Pink (001 API)	Dark Indigo (288)	Light Rose AB FC (223 AB FC)	Tangerine (259)
Crystal Astral Pink FC (001 API FC)	Dark Moss Green (260)	Light Sapphire (211)	Tanzanite (539)
Crystal Aurore Boreale (001 AB)	Denim Blue (266)	Light Siam (227)	Tanzanite AB FC (539 AB FC)
Crystal Aurore Boreale 2x (001 AB2)	Emerald (205)	Light Siam AB FC (227 AB FC)	Topaz (203)
Crystal Aurore Boreale FC (001 AB FC)	Emerald AB FC (205 AB FC)	Light Silk (261)	Topaz AB FC (203 AB FC)
Crystal Aurore Boreale Satin (001 ABSAT)	Erinite (360)	Light Smoked Topaz (221)	Topaz Blend (722)
Crystal Bermuda Blue (001 BBL)	Fern Green (291)	Light Topaz (226)	Turquoise (267)
Crystal Blue Shade** (001 BLSH)	Fern Green-Topaz Blend (724)	Light Turquoise (263)	Turquoise AB FC (267 AB FC)
Crystal Bronze Shade** (001 BRSH)	Fireopal (237)	Mocca (286)	Vintage Rose (319)
Crystal Bronze Shade FC** (001 BRSH FC)	Fuchsia (502)	Montana (207)	Violet (371)
Crystal Comet Argent Light** (001 CAL)	Fuchsia AB FC (502 AB FC)	Montana AB FC (207 AB FC)	Violet AB FC (371 AB FC)
Crystal Comet Argent Light FC** (001 CAL FC)	Garnet (241)	Olivine (228)	White Alabaster (281)
Crystal Copper** (001 COP)	Greige (284)	Pacific Opal (390)	White Opal (234)
Crystal Dorado 2x** (001 DOR2)	Hyacinth (236)	Padparadscha (542)	White Opal AB FC (234 AB FC)
Crystal Golden Shadow** (001 GSHA)	Indian Pink (289)	Padparadscha AB FC (542 AB FC)	
Crystal Heliotrope** (001 HEL)	Indian Sapphire (217)	Palace Green Opal (393)	
	Indian Sapphire AB FC (217 AB FC)	Peridot (214)	

This color chart is valid for the product groups Beads, BeCharmed & Pavé and Pendants.

The displayed assortment is not entirely available for all products within the product groups. For details on available colors and effects, please see the product matrix for the respective item.

Classic Colors: This color range offers a wide choice of traditional Swarovski crystal colors.

Exclusive Colors: This color range is offered exclusively by Swarovski.

The standard assortment of colors and effects may vary according to the product group.

Slight changes in shades are unavoidable. Colors may vary according to cut and shape.







































The plating resistance of effects is tested according to Swarovski's plating guidelines (WWW.SWAROVSKI.COM/PROFESSIONAL). Customers are advised to carry out their own tests if customers' plating parameters diverge from Swarovski plating guidelines.

* Colors are only available as special productions.

** Crystals are not resistant to plating and similar processing.

Beads

SUMMARY

1 2 3  5000 2, 3, 4, 5, 6, 7, 8, 10, 12, 14, 16, 18, 20 mm	1 2 3  5055 8x6, 10x8 mm	1 2 3  5540 12, 17 mm
 5003 6, 8, 10, 12, 14 mm	 5056 10x6, 12x8 mm	 5541 11, 15 mm
 5005 8, 12, 16 mm	 5139 12.5 mm	 5542 8, 11 mm
 5020 6, 8, 10 mm	 5181 13x7, 17x9 mm	 5601 4, 6, 8, 10, 12 mm
 5026 6, 8, 10 mm	 5200 6x4, 7.5x5 mm	 5603 8, 10 mm
 5028/4 6, 8, 10 mm	 5203 12x8 mm	 5621 14, 18 mm
 5040 4, 6, 8, 12, 18 mm	 5305 5, 6 mm	 5624 10, 14 mm
 5041 18 mm	 5308 6 mm	 5625 10 mm
 5050 14x10, 22x16 mm	 5328 2.5, 3, 4, 5, 6, 8, 10 mm	 5650 12x8, 16x10 mm
 5051 8x6, 10x8 mm	 5500 9x6, 10.5x7, 12x8 mm	 5714 8, 12 mm
 5052 6, 8 mm	 5520 12 mm	 5727 14 mm
 5053 6, 8 mm	 5523 12, 16 mm	 5742 8, 10 mm
 5054 6, 8 mm	 5535 19x5, 23.5x5 mm	 5743 12, 17 mm

SUMMARY

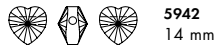
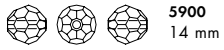
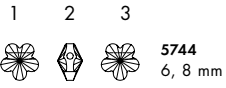

Beads

5000

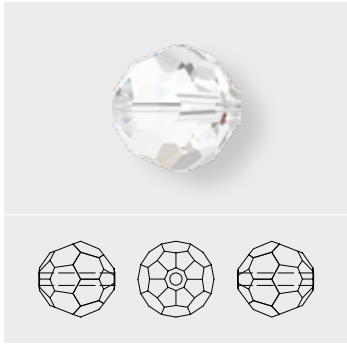

Size	2 mm	3 mm	4 mm	5 mm	6 mm	7 mm	8 mm	10 mm	12 mm	14 mm	16 mm	18 mm	20 mm
------	------	------	------	------	------	------	------	-------	-------	-------	-------	-------	-------

Crystal

Crystal (001)

Colors

Plain Colors

- Amethyst (204)
- Aquamarine (202)
- Black Diamond (215)
- Blue Zircon (229)
- Capri Blue (243)
- Chrysolite (238)
- Dark Indigo (288)
- Dark Moss Green (260)
- Denim Blue (266)
- Emerald (205)
- Erinite (360)
- Fern Green (291)
- Fireopal (237)
- Fuchsia (502)
- Greige (284)
- Indian Pink (289)
- Indian Sapphire (217)
- Indicolite (379)
- Jet (280)
- Jonquil (213)
- Light Amethyst (212)
- Light Azore (361)
- Light Colorado Topaz (246)
- Light Rose (223)
- Light Sapphire (211)
- Light Siam (227)
- Light Silk (261)
- Light Smoked Topaz (221)
- Light Topaz (226)
- Light Turquoise (263)
- Montana (207)
- Olivine (228)
- Padparadscha (542)
- Peridot (214)
- Purple Velvet (277)
- Rose (209)
- Rose Peach (262)
- Sapphire (206)
- Siam (208)

Crystal (001)	■	■	■	■	■	■	■	■	■	■	■	■	■
Amethyst (204)		■	■		■		■	■					
Aquamarine (202)		■	■		■		■	■					
Black Diamond (215)		■	■		■		■	■					
Blue Zircon (229)			■		■		■						
Capri Blue (243)			■		■		■						
Chrysolite (238)			■		■		■						
Dark Indigo (288)			■		■		■	■					
Dark Moss Green (260)		■	■		■		■	■					
Denim Blue (266)			■		■		■	■					
Emerald (205)		■	■		■		■						
Erinite (360)			■		■		■						
Fern Green (291)			■		■		■						
Fireopal (237)			■		■		■						
Fuchsia (502)	■	■	■		■		■	■					
Greige (284)			■		■		■						
Indian Pink (289)			■		■		■						
Indian Sapphire (217)			■		■		■						
Indicolite (379)			■		■		■						
Jet (280)	■	■	■	■	■		■	■	■	■			
Jonquil (213)			■		■		■						
Light Amethyst (212)			■		■		■						
Light Azore (361)			■		■		■						
Light Colorado Topaz (246)		■	■		■		■						
Light Rose (223)		■	■		■		■						
Light Sapphire (211)			■		■		■						
Light Siam (227)		■	■		■		■	■					
Light Silk (261)			■		■		■						
Light Smoked Topaz (221)			■		■		■						
Light Topaz (226)			■		■		■	■					
Light Turquoise (263)		■	■		■		■	■					
Montana (207)			■		■		■	■					
Olivine (228)			■		■		■						
Padparadscha (542)			■		■		■						
Peridot (214)			■		■		■						
Purple Velvet (277)			■		■		■						
Rose (209)			■		■		■						
Rose Peach (262)			■		■		■						
Sapphire (206)			■		■		■						
Siam (208)		■	■		■		■	■					

Beads

04 Beads

	5000													
	Size	2 mm	3 mm	4 mm	5 mm	6 mm	7 mm	8 mm	10 mm	12 mm	14 mm	16 mm	18 mm	20 mm
Silk (391)				■		■		■						
Smoked Topaz (220)				■		■		■						
Tangerine (259)		■	■	■	■	■		■						
Tanzanite (539)				■		■		■						
Topaz (203)				■		■		■						
Turquoise (267)				■		■		■						
Vintage Rose (319)				■		■		■						
Violet (371)				■		■		■						
White Alabaster (281)				■		■		■						
Opal Colors														
Cyclamen Opal (398)				■		■		■						
Pacific Opal (390)				■		■		■						
Palace Green Opal (393)				■		■		■						
White Opal (234)		■	■			■		■						
Crystal Blend Colors														
Burgundy-Blue Zircon Blend (723)						■		■						
Crystal-Montana Blend (725)						■		■	■					
Fern Green-Topaz Blend (724)						■		■						
Provence Lavender-Chrysolite Blend (726)						■		■	■					
Crystal Effects														
Transparent Effects														
Crystal AB (001 AB)	■	■	■	■	■	■	■	■	■	■	■	■	■	■
Crystal Antique Pink (001 ANTP)				■		■		■						
Crystal Blue Shade (001 BLSH)		■	■			■		■	■					
Crystal Bronze Shade (001 BRSH)		■	■			■		■	■					
Crystal Copper (001 COP)				■		■		■						
Crystal Golden Shadow (001 GSHA)	■	■	■			■		■	■	■				
Crystal Lilac Shadow (001 LISH)		■	■			■		■	■					
Crystal Luminous Green (001 LUMG)		■	■			■		■						
Crystal Moonlight (001 MOL)	■		■			■		■	■					
Crystal Satin (001 SAT)				■		■		■						
Crystal Silver Night (001 SINI)		■	■			■		■						
Crystal Silver Shade (001 SSHA)	■	■	■			■		■						
Crystal Vitrail Medium (001 VM)				■		■		■						
Metallic Effects														
Crystal Dorado (001 DOR)				■		■		■						
Crystal Iridescent Green (001 IRIG)		■	■			■		■	■					
Crystal Metallic Light Gold 2x (001 MLG2)	■		■			■		■						
Crystal Rose Gold (001 ROGL)		■	■			■		■						
Full Coating														
Crystal AB FC (001 AB FC)				■		■		■						
Crystal Astral Pink FC (001 API FC)				■		■		■						

Beads

5000	Size												
	2 mm	3 mm	4 mm	5 mm	6 mm	7 mm	8 mm	10 mm	12 mm	14 mm	16 mm	18 mm	20 mm
Crystal Bronze Shade FC (001 BRSH FC)			■		■		■						
Crystal Comet Argent Light FC (001 CAL FC)			■		■		■						
Crystal Iridescent Green FC (001 IRIG FC)			■		■		■						
Crystal Metallic Blue FC (001 METBL FC)			■		■		■						
Color Effects													
Transparent Effects													
Amethyst AB (204 AB)			■		■		■						
Aquamarine AB (202 AB)			■		■		■						
Jet AB (280 AB)			■		■		■						
Light Rose AB (223 AB)			■		■		■						
Light Siam AB (227 AB)			■		■		■						
Rose AB (209 AB)			■		■		■						
Metallic Effects													
Jet Hematite (280 HEM)		■	■		■		■						
Jet Hematite 2x (280 HEM2)		■	■		■		■						
Full Coating													
Amethyst AB FC (204 AB FC)			■		■		■						
Aquamarine AB FC (202 AB FC)			■		■		■						
Black Diamond AB FC (215 AB FC)			■		■		■						
Capri Blue AB FC (243 AB FC)			■		■		■						
Chrysolite AB FC (238 AB FC)			■		■		■						
Emerald AB FC (205 AB FC)			■		■		■						
Fuchsia AB FC (502 AB FC)			■		■		■						
Indian Sapphire AB FC (217 AB FC)			■		■		■						
Indicolite AB FC (379 AB FC)			■		■		■						
Jet AB FC (280 AB FC)			■		■		■						
Jet Hematite FC (280 HEM FC)			■		■		■						
Jonquil AB FC (213 AB FC)			■		■		■						
Light Amethyst AB FC (212 FC)			■		■		■						
Light Colorado Topaz AB FC (246 AB FC)			■		■		■						
Light Rose AB FC (223 AB FC)			■		■		■						
Light Siam AB FC (227 AB FC)			■		■		■						
Montana AB FC (207 AB FC)			■		■		■						
Padparadscha AB FC (542 AB FC)			■		■		■						
Peridot AB FC (214 AB FC)			■		■		■						
Rose AB FC (209 AB FC)			■		■		■						
Sapphire AB FC (206 AB FC)			■		■		■						
Siam AB FC (208 AB FC)			■		■		■						
Tanzanite AB FC (539 AB FC)			■		■		■						
Topaz AB FC (203 AB FC)			■		■		■						
Turquoise AB FC (267 AB FC)			■		■		■						
Violet AB FC (371 AB FC)			■		■		■						
White Opal AB FC (234 AB FC)			■		■		■						

Beads

5003

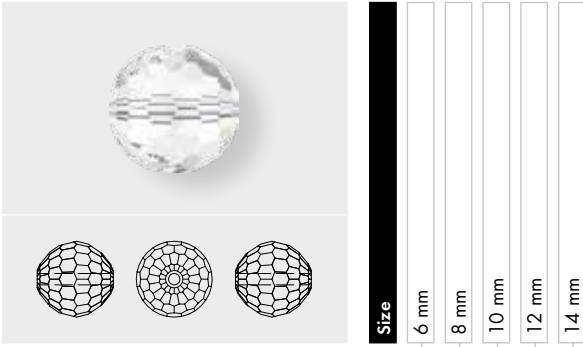

Crystal	6 mm	8 mm	10 mm	12 mm	14 mm
Crystal (001)	■	■	■	■	■
Crystal Effects					
Transparent Effects					
Crystal AB (001 AB)	■	■	■	■	■

5005 Chessboard Bead

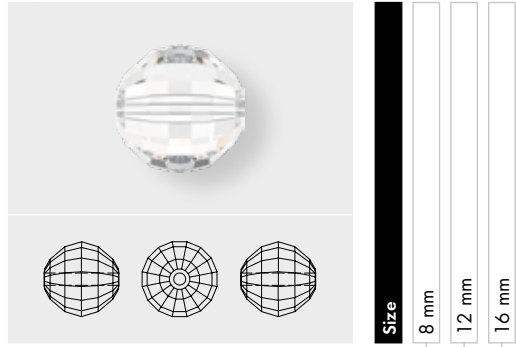

Crystal	8 mm	12 mm	16 mm
Crystal (001)	■	■	■
Crystal Effects			
Transparent Effects			
Crystal AB (001 AB)	■	■	■
Crystal Golden Shadow (001 GSHA)	■	■	■

5020 Helix Bead

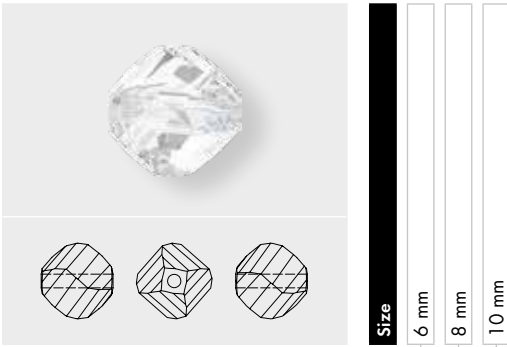

Crystal	6 mm	8 mm	10 mm
Crystal (001)	■	■	■
Crystal Effects			
Transparent Effects			
Crystal AB (001 AB)	■	■	■
Crystal Golden Shadow (001 GSHA)	■	■	■

Beads

5026 Cabochette Bead

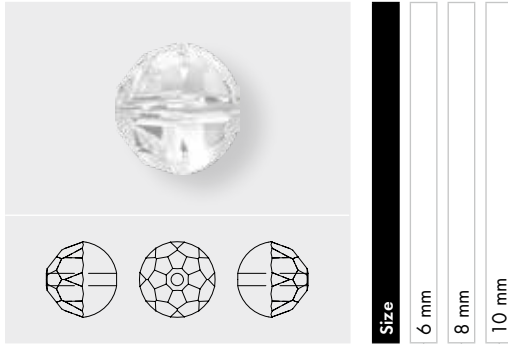

	6 mm	8 mm	10 mm
Crystal			
Crystal (001)	■	■	■
Colors			
Plain Colors			
Amethyst (204)	■	■	■
Black Diamond (215)	■	■	■
Dark Moss Green (260)	■	■	■
Fern Green (291)	■	■	■
Jet (280)	■	■	■
Light Silk (261)	■	■	■
Light Topaz (226)	■	■	■
Light Turquoise (263)	■	■	■
Siam (208)	■	■	■
Crystal Effects			
Transparent Effects			
Crystal Blue Shade (001 BLSH)	■	■	■
Crystal Bronze Shade (001 BRSH)	■	■	■
Crystal Golden Shadow (001 GSHA)	■	■	■
Crystal Lilac Shadow (001 LISH)	■	■	■
Crystal Luminous Green (001 LUMG)	■	■	■
Crystal Satin (001 SAT)	■	■	■
Crystal Silver Shade (001 SSHA)	■	■	■

5028/4 Crystal Globe Bead

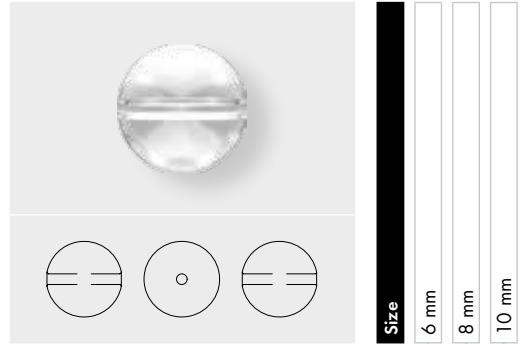

	6 mm	8 mm	10 mm
Crystal			
Crystal (001)	■	■	■
Colors			
Plain Colors			
Amethyst (204)	■	■	■
Aquamarine (202)	■	■	■
Black Diamond (215)	■	■	■
Emerald (205)	■	■	■
Fern Green (291)	■	■	■
Jet (280)	■	■	■
Light Siam (227)	■	■	■
Light Silk (261)	■	■	■
Light Topaz (226)	■	■	■
Peridot (214)	■	■	■
Siam (208)	■	■	■
Crystal Effects			
Transparent Effects			
Crystal AB (001 AB)	■	■	■
Crystal Antique Pink (001 ANTP)	■	■	■
Crystal Blue Shade (001 BLSH)	■	■	■
Crystal Golden Shadow (001 GSHA)	■	■	■
Crystal Lilac Shadow (001 LISH)	■	■	■
Crystal Luminous Green (001 LUMG)	■	■	■
Metallic Effects			
Crystal Iridescent Green (001 IRIG)	■	■	■

Beads

5040 Briolette Bead

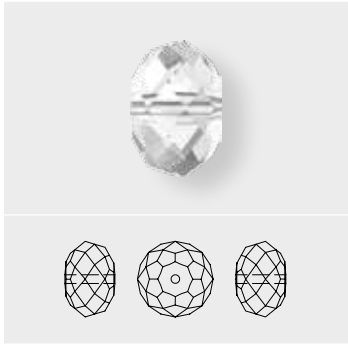

Size	4 mm	6 mm	8 mm	12 mm	18 mm
------	------	------	------	-------	-------

Crystal

Crystal (001)	■	■	■	■	■
---------------	---	---	---	---	---

Colors

Plain Colors

Amethyst (204)	■	■	■		
Aquamarine (202)		■	■	■	
Black Diamond (215)		■	■	■	
Dark Indigo (288)		■	■		
Dark Moss Green (260)	■	■	■		
Denim Blue (266)		■	■	■	
Erinite (360)		■	■	■	
Greige (284)		■	■	■	
Indicolite (379)		■	■		
Jet (280)	■	■	■	■	
Jonquil (213)		■	■		
Light Rose (223)	■	■	■		
Light Siam (227)	■	■	■		
Light Silk (261)		■	■		
Light Turquoise (263)	■	■	■	■	
Mocca (286)		■	■		
Padparadscha (542)		■	■		
Peridot (214)		■	■		
Purple Velvet (277)		■	■		
Rose Peach (262)		■	■		
Siam (208)	■	■	■		
Silk (391)		■	■		
Tangerine (259)	■	■	■		
Tanzanite (539)		■	■		
Vintage Rose (319)		■	■		
Violet (371)		■	■		
Crystal Blend Colors					
Burgundy-Blue Zircon Blend (723)			■		
Crystal-Montana Blend (725)		■	■	■	
Fern Green-Topaz Blend (724)			■		
Provence Lavender-Chrysolite Blend (726)	■	■	■		

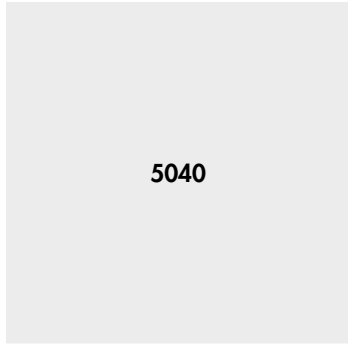

Size	4 mm	6 mm	8 mm	12 mm	18 mm
------	------	------	------	-------	-------

Crystal Effects

Transparent Effects

Crystal AB (001 AB)	■	■	■	■	■
Crystal Antique Pink (001 ANTP)		■	■	■	
Crystal Astral Pink (001 API)	■	■	■	■	■
Crystal Blue Shade (001 BLSH)	■	■	■	■	■
Crystal Bronze Shade (001 BRSH)	■	■	■	■	■
Crystal Copper (001 COP)	■	■	■	■	
Crystal Golden Shadow (001 GSHA)	■	■	■	■	
Crystal Lilac Shadow (001 LISH)	■	■	■	■	
Crystal Luminous Green (001 LUMG)		■	■	■	
Crystal Moonlight (001 MOL)		■	■		
Crystal Red Magma (001 REDM)	■	■	■	■	
Crystal Silver Night (001 SINI)	■	■	■	■	
Crystal Silver Shade (001 SSHA)	■	■	■	■	
Transparent Effects					
Crystal Iridescent Green (001 IRIG)	■	■	■		

Beads

5041 Briolette Bead (large hole)

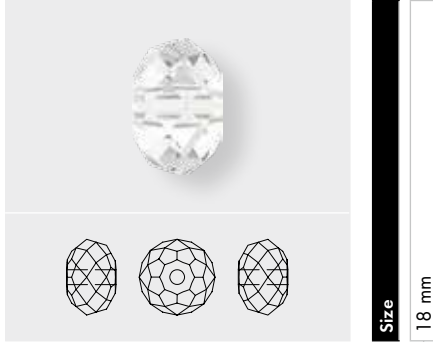

Size

18 mm

Crystal

Crystal (001)

Crystal Effects

Transparent Effects

Crystal AB (001 AB)

Crystal Astral Pink (001 API)

Crystal Golden Shadow (001 GSHA)

Crystal Silver Shade (001 SSHA)

5050 Oval Bead

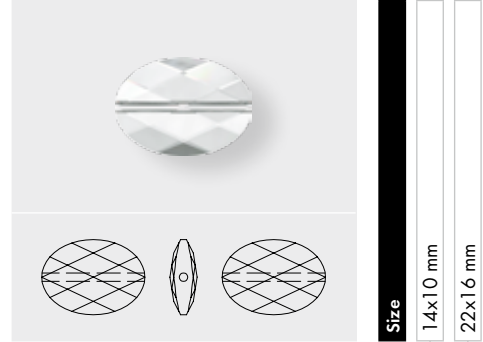

Size

14x10 mm

22x16 mm

Crystal

Crystal (001)

Colors

Plain Colors

Jet (280)

Light Turquoise (263)

Crystal Blend Colors

Provence Lavender-Chrysolite Blend (726)

Crystal Effects

Transparent Effects

Crystal AB (001 AB)

Crystal Blue Shade (001 BLSH)

Crystal Golden Shadow (001 GSHA)

Crystal Lilac Shadow (001 LISH)

Crystal Vitrail Medium P (001 VM)*

Metallic Effects

Crystal Comet Argent Light P (001 CAL)*

Crystal Rose Gold (001 ROGL)

Crystal Rose Gold 2x (001 ROGL2)

* For details about the „protective layer“ please refer to page 24.

Beads

5051 Mini Oval Bead

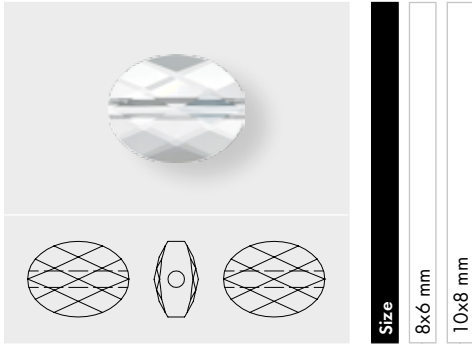

Size
8x6 mm
10x8 mm

Crystal	
Crystal (001)	
Colors	
Plain Colors	
Amethyst (204)	
Aquamarine (202)	
Black Diamond (215)	
Dark Moss Green (260)	
Emerald (205)	
Fern Green (291)	
Indicolite (379)	
Jet (280)	
Light Silk (261)	
Light Turquoise (263)	
Montana (207)	
Rose (209)	
Siam (208)	
Smoked Topaz (220)	
Sunflower (292)	
Tangerine (259)	
Tanzanite (539)	
Crystal Effects	
Transparent Effects	
Crystal AB (001 AB)	
Crystal Antique Pink (001 ANTP)	
Crystal Blue Shade (001 BLSH)	
Crystal Bronze Shade (001 BRSH)	
Crystal Golden Shadow (001 GSHA)	
Crystal Lilac Shadow (001 LISH)	
Crystal Red Magma (001 REDM)	
Crystal Silver Night (001 SINI)	
Crystal Silver Shade (001 SSHA)	
Metallic Effects	
Crystal Iridescent Green (001 IRIG)	
Crystal Rose Gold (001 ROGL)	
Crystal Rose Gold 2x (001 ROGL2)	

5052 Mini Round Bead

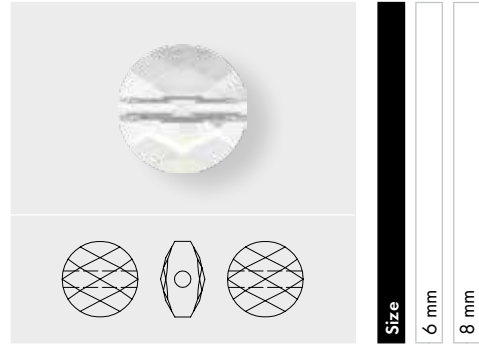

Size
6 mm
8 mm

Crystal	
Crystal (001)	
Colors	
Plain Colors	
Amethyst (204)	
Aquamarine (202)	
Black Diamond (215)	
Dark Moss Green (260)	
Emerald (205)	
Fern Green (291)	
Indicolite (379)	
Jet (280)	
Light Silk (261)	
Light Turquoise (263)	
Montana (207)	
Rose (209)	
Siam (208)	
Smoked Topaz (220)	
Sunflower (292)	
Tangerine (259)	
Tanzanite (539)	
Crystal Effects	
Transparent Effects	
Crystal AB (001 AB)	
Crystal Antique Pink (001 ANTP)	
Crystal Blue Shade (001 BLSH)	
Crystal Bronze Shade (001 BRSH)	
Crystal Golden Shadow (001 GSHA)	
Crystal Lilac Shadow (001 LISH)	
Crystal Red Magma (001 REDM)	
Crystal Silver Night (001 SINI)	
Crystal Silver Shade (001 SSHA)	
Metallic Effects	
Crystal Iridescent Green (001 IRIG)	
Crystal Rose Gold (001 ROGL)	
Crystal Rose Gold 2x (001 ROGL2)	

Beads

5053 Mini Square Bead

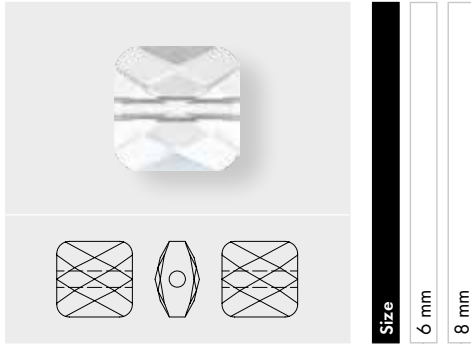

Crystal	
Crystal (001)	■ ■
Colors	
Plain Colors	
Amethyst (204)	■ ■
Aquamarine (202)	■ ■
Black Diamond (215)	■ ■
Dark Moss Green (260)	■ ■
Emerald (205)	■ ■
Fern Green (291)	■ ■
Indicolite (379)	■ ■
Jet (280)	■ ■
Light Silk (261)	■ ■
Light Turquoise (263)	■ ■
Montana (207)	■ ■
Rose (209)	■ ■
Siam (208)	■ ■
Smoked Topaz (220)	■ ■
Sunflower (292)	■ ■
Tangerine (259)	■ ■
Tanzanite (539)	■ ■
Crystal Effects	
Transparent Effects	
Crystal AB (001 AB)	■ ■
Crystal Antique Pink (001 ANTP)	■ ■
Crystal Blue Shade (001 BLSH)	■ ■
Crystal Bronze Shade (001 BRSH)	■ ■
Crystal Golden Shadow (001 GSHA)	■ ■
Crystal Lilac Shadow (001 LISH)	■ ■
Crystal Red Magma (001 REDM)	■ ■
Crystal Silver Night (001 SINI)	■ ■
Crystal Silver Shade (001 SSHA)	■ ■
Metallic Effects	
Crystal Iridescent Green (001 IRIG)	■ ■
Crystal Rose Gold (001 ROGL)	■ ■
Crystal Rose Gold 2x (001 ROGL2)	■ ■

5054 Mini Rhombus Bead

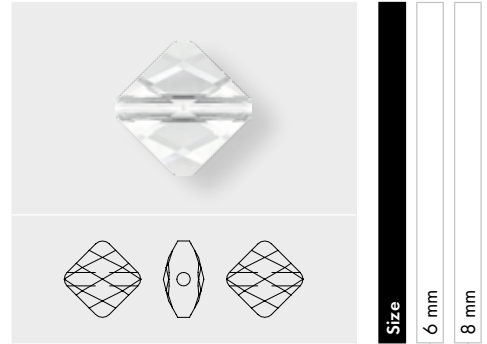

Crystal	
Crystal (001)	■ ■
Colors	
Plain Colors	
Dark Moss Green (260)	■ ■
Indicolite (379)	■ ■
Jet (280)	■ ■
Light Silk (261)	■ ■
Light Turquoise (263)	■ ■
Rose (209)	■ ■
Siam (208)	■ ■
Tangerine (259)	■ ■
Crystal Effects	
Transparent Effects	
Crystal AB (001 AB)	■ ■
Crystal Antique Pink (001 ANTP)	■ ■
Crystal Blue Shade (001 BLSH)	■ ■
Crystal Bronze Shade (001 BRSH)	■ ■
Crystal Golden Shadow (001 GSHA)	■ ■
Crystal Lilac Shadow (001 LISH)	■ ■
Crystal Red Magma (001 REDM)	■ ■
Crystal Silver Night (001 SINI)	■ ■
Crystal Silver Shade (001 SSHA)	■ ■
Metallic Effects	
Crystal Iridescent Green (001 IRIG)	■ ■
Crystal Rose Gold (001 ROGL)	■ ■

Beads

5055 Mini Rectangle Bead

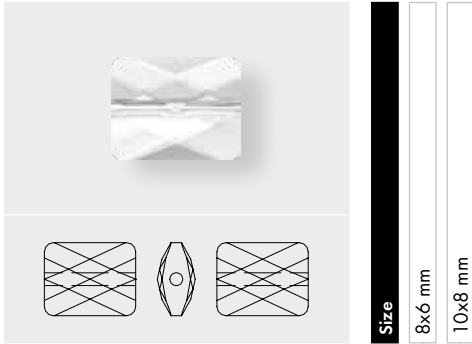

Crystal	
Crystal (001)	■ ■
Colors	
Plain Colors	
Dark Moss Green (260)	■ ■
Indicolite (379)	■ ■
Jet (280)	■ ■
Light Silk (261)	■ ■
Light Turquoise (263)	■ ■
Rose (209)	■ ■
Siam (208)	■ ■
Tangerine (259)	■ ■
Crystal Effects	
Transparent Effects	
Crystal AB (001 AB)	■ ■
Crystal Antique Pink (001 ANTP)	■ ■
Crystal Blue Shade (001 BLSH)	■ ■
Crystal Bronze Shade (001 BRSH)	■ ■
Crystal Golden Shadow (001 GSHA)	■ ■
Crystal Lilac Shadow (001 LISH)	■ ■
Crystal Red Magma (001 REDM)	■ ■
Crystal Silver Night (001 SINI)	■ ■
Crystal Silver Shade (001 SSHA)	■ ■
Metallic Effects	
Crystal Iridescent Green (001 IRIG)	■ ■
Crystal Rose Gold (001 ROGL)	■ ■

5056 Mini Drop Bead

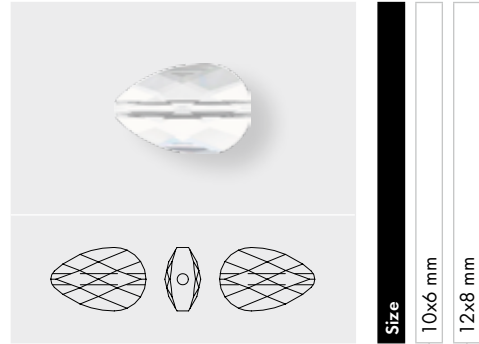

Crystal	
Crystal (001)	■ ■
Colors	
Plain Colors	
Dark Moss Green (260)	■ ■
Indicolite (379)	■ ■
Jet (280)	■ ■
Light Silk (261)	■ ■
Light Turquoise (263)	■ ■
Rose (209)	■ ■
Siam (208)	■ ■
Tangerine (259)	■ ■
Crystal Effects	
Transparent Effects	
Crystal AB (001 AB)	■ ■
Crystal Antique Pink (001 ANTP)	■ ■
Crystal Blue Shade (001 BLSH)	■ ■
Crystal Bronze Shade (001 BRSH)	■ ■
Crystal Golden Shadow (001 GSHA)	■ ■
Crystal Lilac Shadow (001 LISH)	■ ■
Crystal Red Magma (001 REDM)	■ ■
Crystal Silver Night (001 SINI)	■ ■
Crystal Silver Shade (001 SSHA)	■ ■
Metallic Effects	
Crystal Iridescent Green (001 IRIG)	■ ■
Crystal Rose Gold (001 ROGL)	■ ■

Beads

5139 Ring Bead

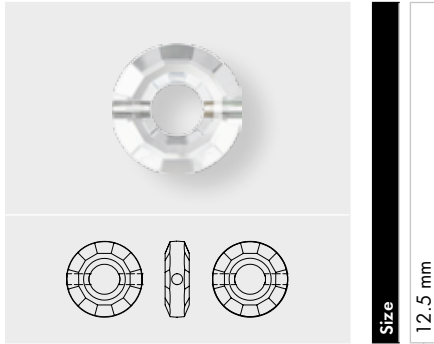

Size

12.5 mm

Crystal

Crystal (001)

Colors

Plain Colors

Light Turquoise (263)

Crystal Effects

Transparent Effects

Crystal AB (001 AB)

Crystal Astral Pink (001 API)

Crystal Golden Shadow (001 GSHA)

Crystal Silver Night (001 SINI)

Metallic Effects

Crystal Rose Gold (001 ROGL)

Crystal Rose Gold 2x (001 ROGL2)

5181 Keystone Bead (two holes)

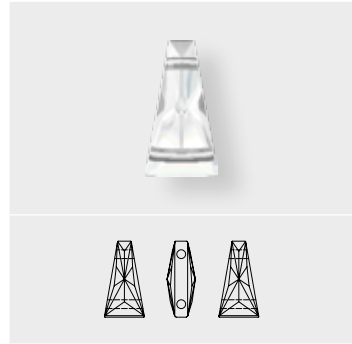

Size

13x7 mm

17x9 mm

Crystal

Crystal (001)

Colors

Plain Colors

Jet (280)

Crystal Effects

Transparent Effects

Crystal AB (001 AB)

Crystal Golden Shadow (001 GSHA)

5200

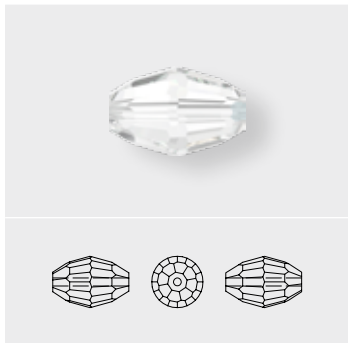

Size

6x4 mm

7.5x5 mm

Crystal

Crystal (001)

Colors

Plain Colors

Jet (280)

Crystal Effects

Transparent Effects

Crystal AB (001 AB)

5203 Polygon Bead

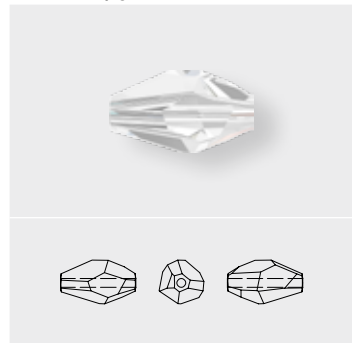

Size

12x8 mm

Crystal

Crystal (001)

Crystal Effects

Transparent Effects

Crystal AB (001 AB)

Beads

5305

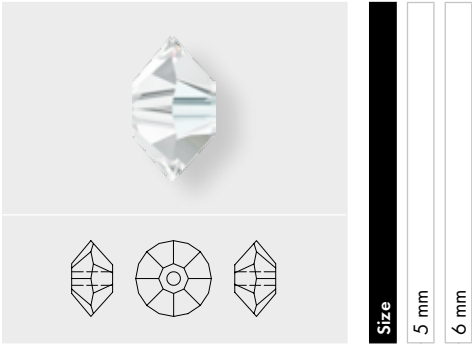

Size
5 mm
6 mm

- Crystal**
- Crystal (001)
- Colors**
- Plain Colors
- Jet (280)
- Crystal Effects**
- Transparent Effects
- Crystal AB (001 AB)

5308

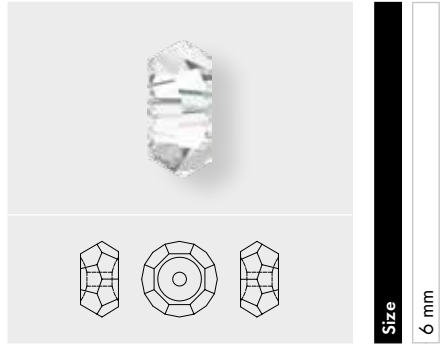

Size
6 mm

- Crystal**
- Crystal (001)
- Crystal Effects**
- Transparent Effects
- Crystal AB (001 AB)

Beads

5328 XILION Bead

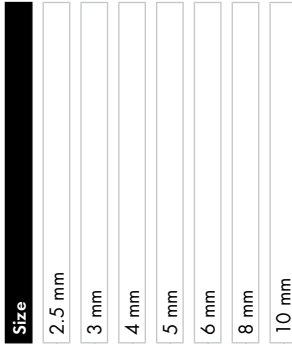
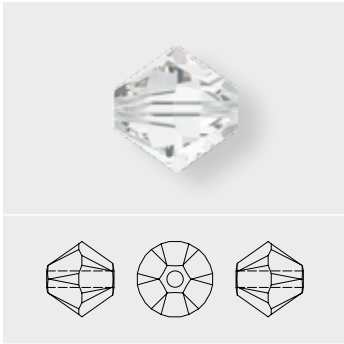

Crystal

Crystal (001)

Colors

Plain Colors

- Amethyst (204)
- Aquamarine (202)
- Black Diamond (215)
- Blue Zircon (229)
- Burgundy (515)
- Capri Blue (243)
- Chrysolite (238)
- Citrine (249)
- Dark Indigo (288)
- Dark Moss Green (260)
- Denim Blue (266)
- Emerald (205)
- Erinite (360)
- Fern Green (291)
- Fireopal (237)
- Fuchsia (502)
- Garnet (241)
- Greige (284)
- Hyacinth (236)
- Indian Pink (289)
- Indian Sapphire (217)
- Indicolite (379)
- Jet (280)
- Jonquil (213)
- Khaki (550)
- Light Amethyst (212)
- Light Azore (361)
- Light Colorado Topaz (246)
- Light Peach (362)
- Light Rose (223)
- Light Sapphire (211)
- Light Siam (227)
- Light Silk (261)
- Light Smoked Topaz (221)
- Light Topaz (226)
- Light Turquoise (263)
- Mocca (286)

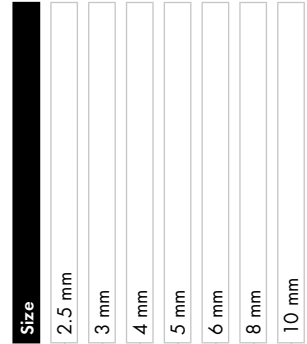
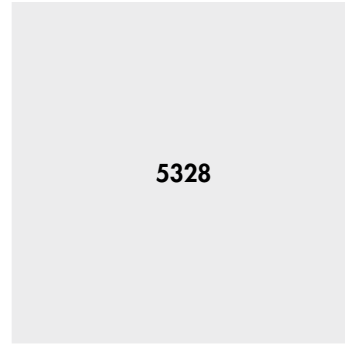

- Montana (207)
 - Olivine (228)
 - Padparadscha (542)
 - Peridot (214)
 - Provence Lavender (283)
 - Purple Velvet (277)
 - Rosaline (508)
 - Rose (209)
 - Rose Peach (262)
 - Ruby (501)
 - Sapphire (206)
 - Siam (208)
 - Silk (391)
 - Smoked Topaz (220)
 - Smoky Quartz (225)
 - Sun (248)
 - Sunflower (292)
 - Tangerine (259)
 - Tanzanite (539)
 - Topaz (203)
 - Turquoise (267)
 - Vintage Rose (319)
 - Violet (371)
 - White Alabaster (281)
- #### Opal Colors
- Air Blue Opal (285)
 - Caribbean Blue Opal (394)
 - Chrysolite Opal (294)
 - Cyclamen Opal (398)
 - Light Grey Opal (383)
 - Pacific Opal (390)
 - Palace Green Opal (393)
 - Rose Water Opal (395)
 - Sand Opal (287)
 - White Opal (234)
- #### Crystal Blend Colors
- Burgundy-Blue Zircon Blend (723)
 - Crystal-Montana Blend (725)
 - Fern Green-Topaz Blend (724)
 - Provence Lavender-Chrysolite Blend (726)

Beads

04 Beads

5328		Size	2.5 mm	3 mm	4 mm	5 mm	6 mm	8 mm	10 mm
Crystal Effects									
Transparent Effects									
Crystal AB (001 AB)			■	■	■	■	■	■	■
Crystal AB 2x (001 AB2)				■	■	■	■		
Crystal AB Satin (001 ABSAT)				■	■				
Crystal Antique Pink (001 ANTP)				■	■	■	■		
Crystal Astral Pink (001 API)				■	■	■	■		
Crystal Blue Shade (001 BLSH)				■	■	■	■	■	■
Crystal Bronze Shade (001 BRSH)				■	■				
Crystal Copper (001 COP)				■	■	■	■		
Crystal Golden Shadow (001 GSHA)		■	■	■	■	■	■	■	
Crystal Heliotrope (001 HEL)			■	■					
Crystal Lilac Shadow (001 LISH)			■	■	■	■	■	■	
Crystal Luminous Green (001 LUMG)			■	■	■	■			
Crystal Moonlight (001 MOL)			■	■	■	■			
Crystal Red Magma (001 REDM)			■	■	■				
Crystal Satin (001 SAT)			■	■	■	■			
Crystal Silver Night (001 SINI)			■	■	■	■			
Crystal Silver Shade (001 SSHA)		■	■	■	■	■	■	■	
Crystal Vitrail Medium (001 VM)			■	■		■			
Metallic Effects									
Crystal CAL (001 CAL)			■	■	■	■			
Crystal Dorado 2x (001 DOR2)			■	■	■	■			
Crystal Iridescent Green (001 IRIG)			■	■	■	■			
Crystal Iridescent Green 2x (001 IRIG2)				■					
Crystal Metallic Blue 2x (001 METBL2)			■	■	■	■			
Crystal Metallic Light Gold 2x (001 MLG2)			■	■	■	■			
Crystal Rose Gold (001 ROGL)			■	■	■	■			
Crystal Rose Gold 2x (001 ROGL2)			■	■	■	■			
Color Effects									
Transparent Effects									
Amethyst AB (204 AB)			■	■	■	■			
Amethyst AB 2x (204 AB2)				■					
Aquamarine AB (202 AB)			■	■	■	■			
Aquamarine AB 2x (202 AB2)				■					
Aquamarine Satin (202 SAT)			■						
Black Diamond AB (215 AB)			■	■	■	■			
Black Diamond AB 2x (215 AB2)				■					
Blue Zircon AB (229 AB)			■						
Blue Zircon AB 2x (229 AB2)				■					
Capri Blue AB (243 AB)			■	■					

5328		Size	2.5 mm	3 mm	4 mm	5 mm	6 mm	8 mm	10 mm
Capri Blue AB 2x (243 AB2)					■				
Chrysolite AB (238 AB)					■				
Chrysolite AB 2x (238 AB2)					■				
Dark Moss Green AB (260 AB)					■				
Dark Moss Green AB 2x (260 AB2)					■				
Emerald AB (205 AB)				■	■				
Emerald AB 2x (205 AB2)					■				
Erinite AB (360 AB)					■				
Fireopal AB (237 AB)					■				
Fireopal AB 2x (237 AB2)					■				
Fuchsia AB (502 AB)				■	■				
Fuchsia AB 2x (502 AB2)					■				
Hyacinth AB (236 AB)					■				
Hyacinth AB 2x (236 AB2)					■				
Indian Sapphire AB (217 AB)					■				
Indicolite AB (379 AB)								■	
Jet AB (280 AB)				■	■	■	■		
Jet AB 2x (280 AB2)				■	■	■	■		
Jonquil AB (213 AB)							■		
Jonquil AB 2x (213 AB2)							■		
Jonquil Satin (213 SAT)							■		
Light Amethyst AB (212 AB)				■	■				
Light Amethyst AB 2x (212 AB2)					■				
Light Azore AB (361 AB)					■				
Light Azore AB 2x (361 AB2)					■				
Light Colorado Topaz AB (246 AB)				■	■	■	■		
Light Colorado Topaz AB 2x (246 AB2)					■				
Light Peach AB (362 AB)					■				
Light Peach Satin (362 SAT)					■				
Light Rose AB (223 AB)				■	■	■	■		
Light Rose AB 2x (223 AB2)					■				
Light Rose Satin (223 SAT)					■				
Light Sapphire AB (211 AB)				■	■				
Light Sapphire AB 2x (211 AB2)					■				
Light Siam AB (227 AB)				■	■	■	■		
Light Siam AB 2x (227 AB2)					■				
Light Siam Satin (227 SAT)					■				
Light Smoked Topaz AB (221 AB)					■				
Light Topaz AB (226 AB)					■				
Light Topaz AB 2x (226 AB2)					■				
Montana AB (207 AB)				■	■				

Beads

5328	Size	2.5 mm	3 mm	4 mm	5 mm	6 mm	8 mm	10 mm
	Montana AB 2x (207 AB2)				■			
Olivine AB (228 AB)			■	■				
Pacific Opal AB 2x (390 AB2)				■				
Peridot AB (214 AB)				■				
Peridot AB 2x (214 AB2)				■				
Purple Velvet AB (277 AB)				■				
Rose AB (209 AB)			■	■	■	■		
Rose AB 2x (209 AB2)				■				
Rose Satin (209 SAT)				■				
Rose Water Opal AB 2x (395 AB2)				■				
Ruby AB (501 AB)				■				
Sapphire AB (206 AB)			■	■				
Sapphire AB 2x (206 AB2)				■				
Siam AB (208 AB)				■	■			
Siam AB 2x (208 AB2)				■				
Smoked Topaz AB (220 AB)				■				
Sun AB 2x (248 AB2)				■				
Tangerine AB (259 AB)				■				
Tangerine AB 2x (259 AB2)				■				
Tanzanite AB (539 AB)			■	■	■	■		
Tanzanite AB 2x (539 AB2)				■				
Topaz AB (203 AB)				■				
Topaz AB 2x (203 AB2)				■				
Turquoise AB (267 AB)			■	■				
Turquoise AB 2x (267 AB2)				■				
Violet AB (371 AB)			■	■		■		
Violet AB 2x (371 AB2)				■				
White Alabaster AB 2x (281 AB2)				■				
White Opal AB (234 AB)			■	■				
White Opal AB 2x (234 AB2)				■				
Metallic Effects								
Jet Hematite (280 HEM)			■	■	■	■		
Jet Hematite 2x (280 HEM2)			■	■	■	■		
Jet Nut 2x (280 NUT2)			■	■				

Beads

5500

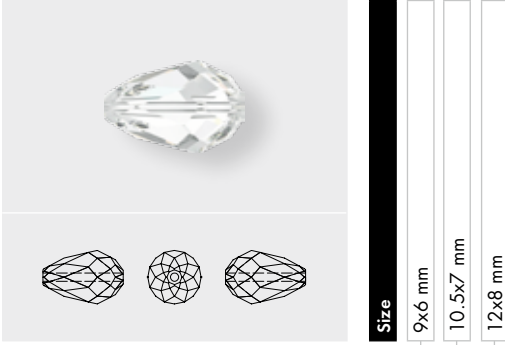

Size
9x6 mm
10.5x7 mm
12x8 mm

- Crystal**
- Crystal (001)
- Colors**
- Plain Colors
- Jet (280)
- Siam (208)
- Crystal Effects**
- Transparent Effects
- Crystal AB (001 AB)

5520 Graphic Bead



Size
12 mm

- Crystal**
- Crystal (001)
- Colors**
- Plain Colors
- Jet (280)
- Crystal Effects**
- Transparent Effects
- Crystal AB (001 AB)
- Crystal Golden Shadow (001 GSHA)

5523 Cosmic Bead



Size
12 mm
16 mm

- Crystal**
- Crystal (001)
- Colors**
- Plain Colors
- Jet (280)
- Crystal Effects**
- Transparent Effects
- Crystal AB (001 AB)
- Crystal Astral Pink (001 API)
- Crystal Golden Shadow (001 GSHA)

5535 Column Bead (two holes)

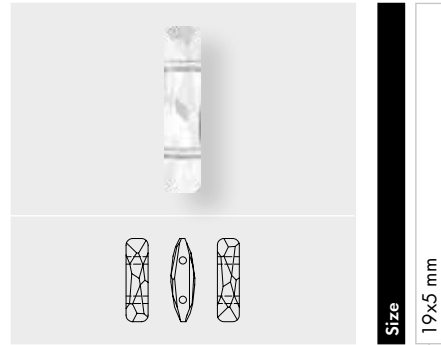

Size
19x5 mm
23.5x5 mm

- Crystal**
- Crystal (001)
- Colors**
- Plain Colors
- Dark Moss Green (260)
- Crystal Effects**
- Transparent Effects
- Crystal AB (001 AB)
- Crystal Lilac Shadow (001 LISH)
- Metallic Effects**
- Crystal Rose Gold (001 ROGL)
- Crystal Rose Gold 2x (001 ROGL2)

Beads

5540 Artemis Bead

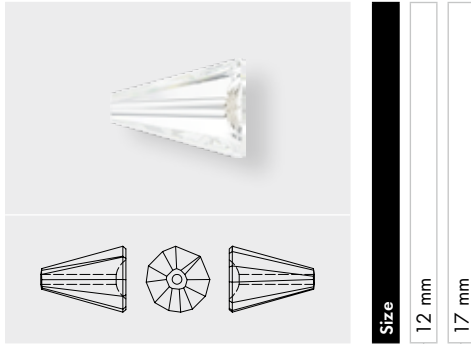

Size
12 mm
17 mm

Crystal	
<input type="checkbox"/> Crystal (001)	<input type="checkbox"/>
Colors	
Plain Colors	
<input type="checkbox"/> Amethyst (204)	<input type="checkbox"/>
<input type="checkbox"/> Aquamarine (202)	<input type="checkbox"/>
<input type="checkbox"/> Dark Indigo (288)	<input type="checkbox"/>
<input type="checkbox"/> Dark Moss Green (260)	<input type="checkbox"/>
<input type="checkbox"/> Jet (280)	<input type="checkbox"/>
<input type="checkbox"/> Olivine (228)	<input type="checkbox"/>
Crystal Effects	
Transparent Effects	
<input type="checkbox"/> Crystal AB (001 AB)	<input type="checkbox"/>
<input type="checkbox"/> Crystal Astral Pink (001 API)	<input type="checkbox"/>
<input type="checkbox"/> Crystal Copper (001 COP)	<input type="checkbox"/>
<input type="checkbox"/> Crystal Golden Shadow (001 GSHA)	<input type="checkbox"/>
<input type="checkbox"/> Crystal Lilac Shadow (001 LISH)	<input type="checkbox"/>
Metallic Effects	
<input type="checkbox"/> Crystal Rose Gold (001 ROGL)	<input type="checkbox"/>
Color Effects	
Metallic Effects	
<input type="checkbox"/> Jet Hematite (280 HEM)	<input type="checkbox"/>

5541 Dome Bead large

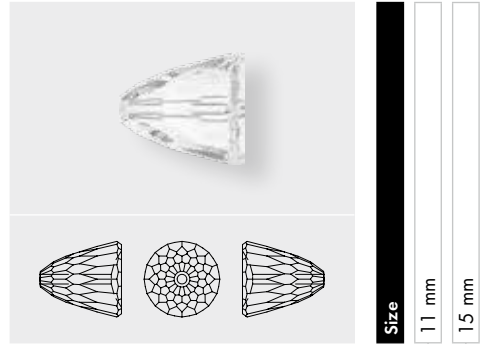

Size
11 mm
15 mm

Crystal	
<input type="checkbox"/> Crystal (001)	<input type="checkbox"/>
Colors	
Plain Colors	
<input type="checkbox"/> Amethyst (204)	<input type="checkbox"/>
<input type="checkbox"/> Dark Indigo (288)	<input type="checkbox"/>
<input type="checkbox"/> Dark Moss Green (260)	<input type="checkbox"/>
<input type="checkbox"/> Fuchsia (502)	<input type="checkbox"/>
<input type="checkbox"/> Jet (280)	<input type="checkbox"/>
<input type="checkbox"/> Light Rose (223)	<input type="checkbox"/>
Crystal Effects	
Transparent Effects	
<input type="checkbox"/> Crystal AB (001 AB)	<input type="checkbox"/>
<input type="checkbox"/> Crystal Antique Pink (001 ANTP)	<input type="checkbox"/>
<input type="checkbox"/> Crystal Astral Pink (001 API)	<input type="checkbox"/>
<input type="checkbox"/> Crystal Blue Shade (001 BLSH)	<input type="checkbox"/>
<input type="checkbox"/> Crystal Bronze Shade (001 BRSH)	<input type="checkbox"/>
<input type="checkbox"/> Crystal Golden Shadow (001 GSHA)	<input type="checkbox"/>
<input type="checkbox"/> Crystal Lilac Shadow (001 LISH)	<input type="checkbox"/>
<input type="checkbox"/> Crystal Red Magma (001 REDM)	<input type="checkbox"/>
<input type="checkbox"/> Crystal Silver Shade (001 SSHA)	<input type="checkbox"/>
Metallic Effects	
<input type="checkbox"/> Crystal Rose Gold (001 ROGL)	<input type="checkbox"/>
Color Effects	
Metallic Effects	
<input type="checkbox"/> Jet Hematite (280 HEM)	<input type="checkbox"/>

Beads

5542 Dome Bead small

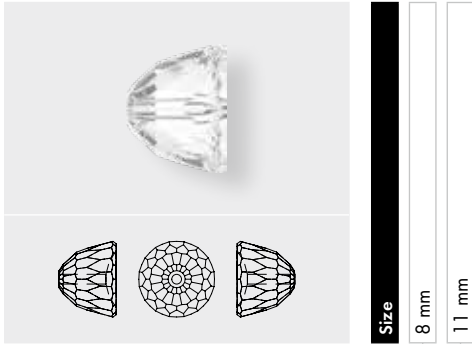

Size	8 mm	11 mm
------	------	-------

Crystal		
Crystal (001)	■	■
Colors		
Plain Colors		
Amethyst (204)	■	■
Dark Indigo (288)	■	■
Dark Moss Green (260)	■	■
Fuchsia (502)	■	■
Jet (280)	■	■
Light Rose (223)	■	■
Crystal Effects		
Transparent Effects		
Crystal AB (001 AB)	■	■
Crystal Antique Pink (001 ANTP)	■	■
Crystal Astral Pink (001 API)	■	■
Crystal Blue Shade (001 BLSH)	■	■
Crystal Bronze Shade (001 BRSH)	■	■
Crystal Golden Shadow (001 GSHA)	■	■
Crystal Lilac Shadow (001 LISH)	■	■
Crystal Red Magma (001 REDM)	■	■
Crystal Silver Shade (001 SSHA)	■	■
Metallic Effects		
Crystal Rose Gold (001 ROGL)	■	■
Color Effects		
Metallic Effects		
Jet Hematite (280 HEM)	■	■

5601



Size	4 mm	6 mm	8 mm	10 mm	12 mm
------	------	------	------	-------	-------

Crystal					
Crystal (001)	■	■	■	■	■
Colors					
Plain Colors					
Amethyst (204)	■	■	■		
Aquamarine (202)	■	■	■		
Dark Moss Green (260)	■	■	■		
Emerald (205)	■	■	■		
Fuchsia (502)		■	■		
Jet (280)		■	■		
Light Siam (227)		■	■		
Light Topaz (226)		■	■		
Light Turquoise (263)	■	■	■		
Peridot (214)	■	■	■		
Sapphire (206)	■	■	■		
Siam (208)	■	■	■		
Tangerine (259)	■	■			
Tanzanite (539)	■	■	■		
Topaz (203)	■	■	■		
Crystal Effects					
Transparent Effects					
Crystal AB B (001 ABB)	■	■	■	■	■
Crystal Blue Shade B (001 BLSHB)	■	■	■		
Crystal Golden Shadow B (001 GSHAB)	■	■	■		
Crystal Lilac Shadow B (001 LISHB)	■	■	■		
Crystal Luminous Green B (001 LUMGB)	■	■	■		
Crystal Silver Night B (001 SINIB)	■	■	■		
Crystal Vitrail Medium B (001 VMB)	■	■	■		
Metallic Effects					
Crystal Rose Gold B (001 ROGLB)	■	■	■		
Crystal Rose Gold B 2x (001 ROGL2B)	■	■	■		

Beads

5603 Graphic Cube Bead

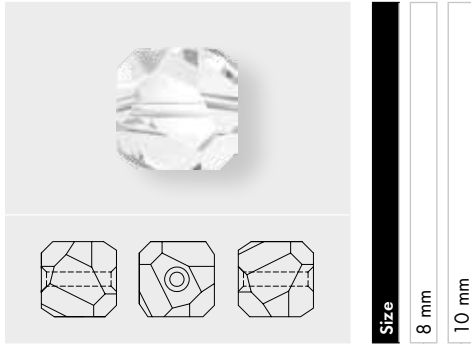

Size	
8 mm	10 mm

Crystal	
Crystal (001)	
Crystal Effects	
Transparent Effects	
Crystal AB (001 AB)	
Crystal Golden Shadow (001 GSHA)	

5621 Twist Bead

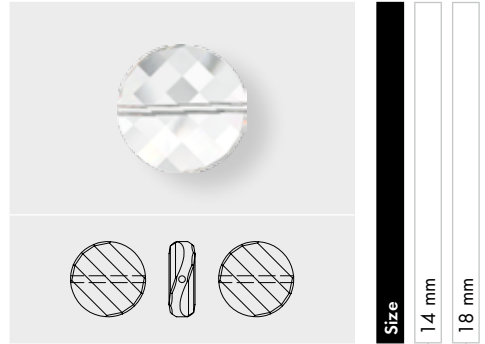

Size	
14 mm	18 mm

Crystal	
Crystal (001)	
Colors	
Plain Colors	
Amethyst (204)	
Aquamarine (202)	
Black Diamond (215)	
Jet (280)	
Crystal Effects	
Transparent Effects	
Crystal Astral Pink (001 API)	
Crystal Golden Shadow (001 GSHA)	
Crystal Silver Night (001 SINI)	
Crystal Vitrail Medium P (001 VM)*	
Metallic Effects	
Crystal Comet Argent Light P (001 CAL)*	

* For details about the „protective layer“ please refer to page 24.

Beads

5624 Stairway Bead

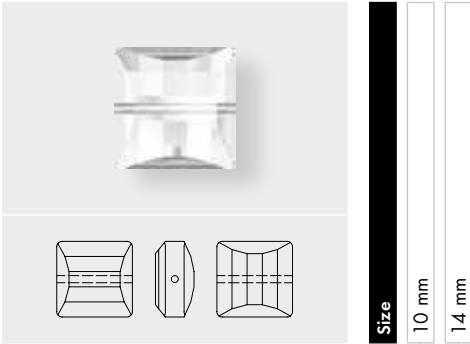

Crystal	
Crystal (001)	■ ■
Colors	
Plain Colors	
Amethyst (204)	■
Denim Blue (266)	■
Jet (280)	■
Light Smoked Topaz (221)	■
Crystal Effects	
Transparent Effects	
Crystal AB (001 AB)	■ ■
Crystal Astral Pink (001 API)	■ ■
Crystal Blue Shade (001 BLSH)	■ ■
Crystal Golden Shadow (001 GSHA)	■ ■
Crystal Lilac Shadow (001 LISH)	■ ■
Crystal Red Magma (001 REDM)	■ ■
Metallic Effects	
Crystal Iridescent Green (001 IRIG)	■ ■

5625 Stairway Bead (two holes)

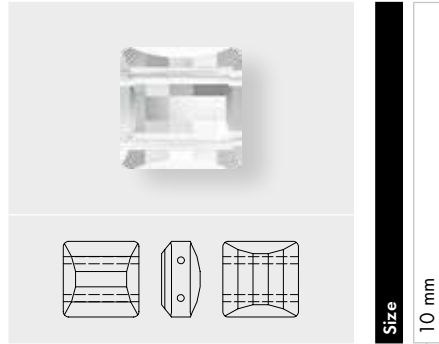

Crystal	
Crystal (001)	■
Colors	
Plain Colors	
Amethyst (204)	■
Aquamarine (202)	■
Black Diamond (215)	■
Dark Moss Green (260)	■
Jet (280)	■
Jonquil (213)	■
Light Smoked Topaz (221)	■
Peridot (214)	■
Rosaline (508)	■
Opal Colors	
White Opal (234)	■
Crystal Effects	
Transparent Effects	
Crystal AB (001 AB)	■
Crystal Blue Shade (001 BLSH)	■
Crystal Copper (001 COP)	■
Crystal Golden Shadow (001 GSHA)	■
Crystal Lilac Shadow (001 LISH)	■
Crystal Red Magma (001 REDM)	■
Crystal Silver Shade (001 SSHA)	■
Metallic Effects	
Crystal Iridescent Green (001 IRIG)	■

Beads

5650 Cubist Bead

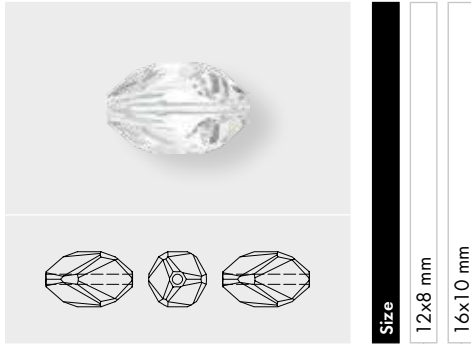

- Size**
12x8 mm
16x10 mm
- Crystal**
- Crystal (001)
- Crystal Effects**
- Transparent Effects**
- Crystal AB (001 AB)
 - Crystal Golden Shadow (001 GSHA)

5714 Star Bead

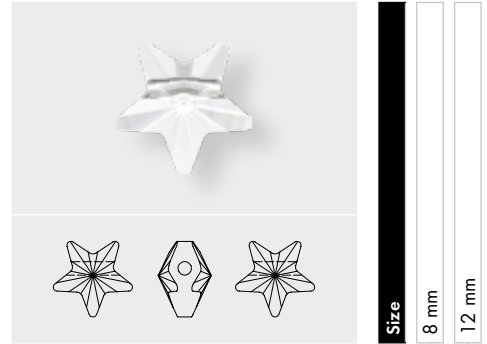

- Size**
8 mm
12 mm
- Crystal**
- Crystal (001)
- Colors**
- Plain Colors**
- Jet (280)
- Crystal Effects**
- Transparent Effects**
- Crystal AB (001 AB)
 - Crystal Golden Shadow (001 GSHA)

5727 Fish Bead

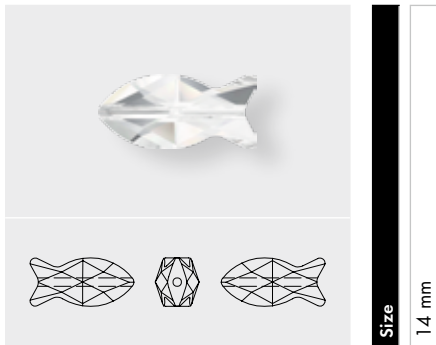

- Size**
14 mm
- Crystal**
- Crystal (001)
- Colors**
- Plain Colors**
- Light Turquoise (263)
- Crystal Effects**
- Transparent Effects**
- Crystal AB (001 AB)
 - Crystal Astral Pink (001 API)
 - Crystal Blue Shade (001 BLSH)
 - Crystal Golden Shadow (001 GSHA)

5742 Heart Bead

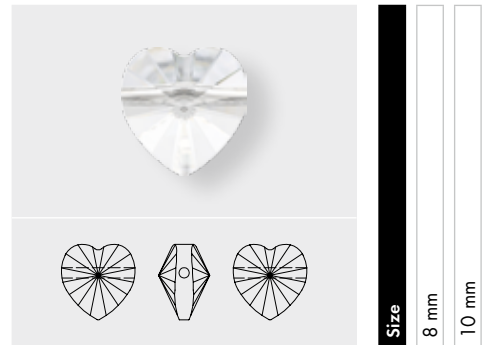

- Size**
8 mm
10 mm
- Crystal**
- Crystal (001)
- Crystal Effects**
- Transparent Effects**
- Crystal AB (001 AB)
 - Crystal Golden Shadow (001 GSHA)

Beads

5743 Wild Heart Bead

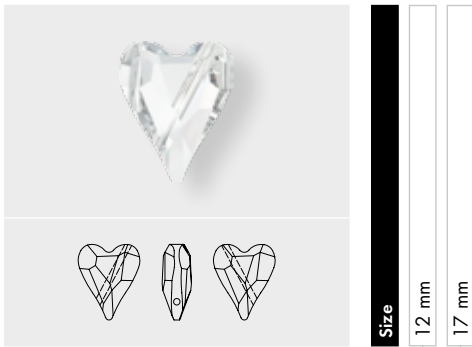

Size
12 mm
17 mm

- Crystal**
- Crystal (001)
- Colors**
- Plain Colors**
- Amethyst (204)
- Aquamarine (202)
- Siam (208)
- Crystal Effects**
- Transparent Effects**
- Crystal AB (001 AB)
- Crystal Golden Shadow (001 GSHA)

5744 Flower Bead

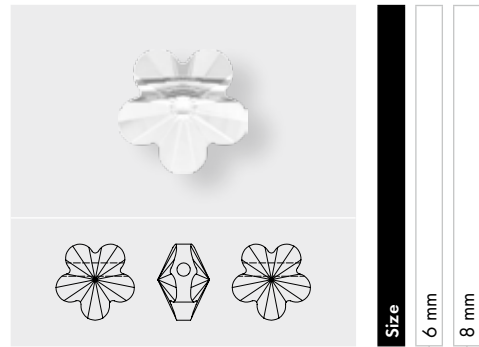

Size
6 mm
8 mm

- Crystal**
- Crystal (001)
- Colors**
- Plain Colors**
- Light Rose (223)
- Violet (371)
- Crystal Effects**
- Transparent Effects**
- Crystal AB (001 AB)

Beads

5747 Double Spike Bead

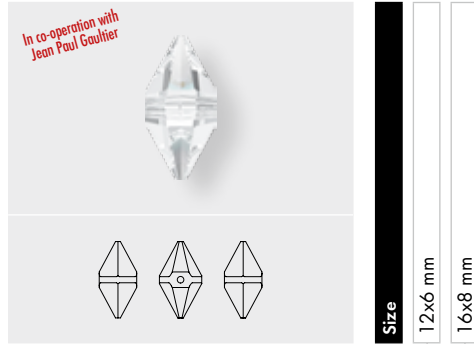

Crystal		
Crystal (001)	■	■
Colors		
Plain Colors		
Jet (280)	■	■
Light Turquoise (263)	■	■
Crystal Effects		
Transparent Effects		
Crystal AB (001 AB)	■	■
Crystal Astral Pink (001 API)	■	■
Crystal Golden Shadow (001 GSHA)	■	■
Crystal Lilac Shadow (001 LISH)	■	■
Crystal Luminous Green (001 LUMG)	■	■
Crystal Silver Night (001 SINI)	■	■
Crystal Silver Night 2x (001 SINI2)	■	■
Crystal Silver Shade (001 SSHA)	■	■
Metallic Effects		
Crystal Iridescent Green (001 IRIG)	■	■
Crystal Metallic Blue 2x (001 METBL2)	■	■
Crystal Metallic Light Gold 2x (001 MLG2)	■	■
Crystal Rose Gold 2x (001 ROGL2)	■	■

5750 Skull Bead

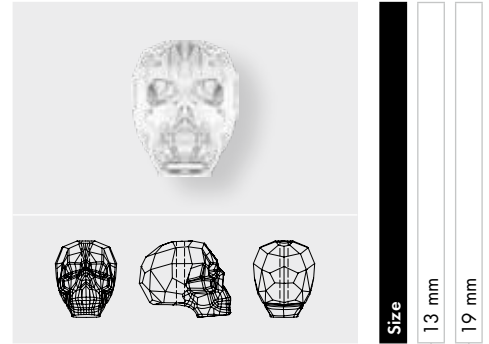

Crystal		
Crystal (001)	■	■
Colors		
Plain Colors		
Denim Blue (266)	■	■
Jet (280)	■	■
Sun (248)	■	■
Crystal Effects		
Transparent Effects		
Crystal AB (001 AB)	■	■
Crystal Astral Pink (001 API)	■	■
Crystal Golden Shadow (001 GSHA)	■	■
Crystal Luminous Green (001 LUMG)	■	■
Crystal Red Magma (001 REDM)	■	■
Crystal Silver Night (001 SINI)	■	■
Crystal Silver Night 2x (001 SINI2)	■	■
Metallic Effects		
Crystal Iridescent Green (001 IRIG)	■	■
Crystal Metallic Blue 2x (001 METBL2)	■	■
Crystal Metallic Light Gold 2x (001 MLG2)	■	■
Crystal Rose Gold 2x (001 ROGL2)	■	■

Beads

5752 Clover Bead

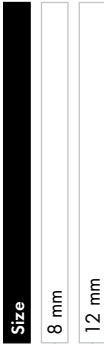
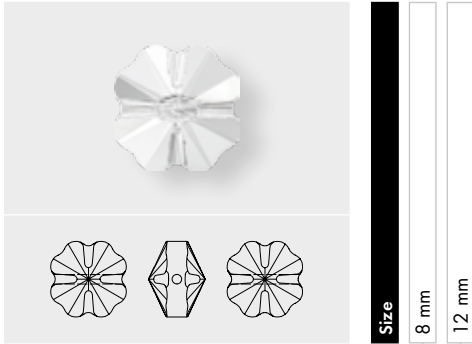

Crystal			
Crystal (001)		■	■
Colors			
Plain Colors			
Dark Moss Green (260)		■	■
Emerald (205)		■	■
Light Siam (227)		■	■
Peridot (214)		■	■
Crystal Effects			
Transparent Effects			
Crystal AB (001 AB)		■	■
Crystal Golden Shadow (001 GSHA)		■	■
Metallic Effects			
Crystal Iridescent Green (001 IRIG)		■	■

5754 Butterfly Bead

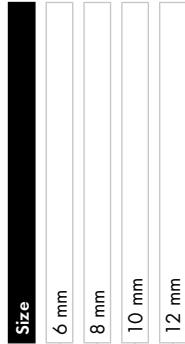
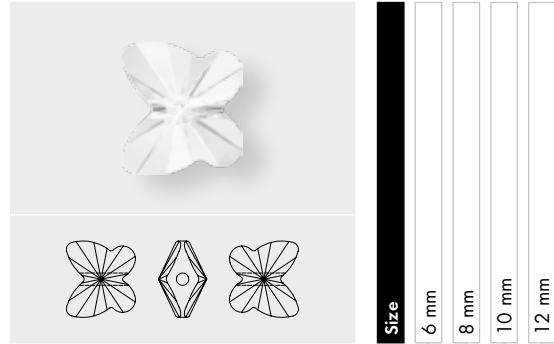

Crystal					
Crystal (001)		■	■	■	■
Colors					
Plain Colors					
Aquamarine (202)		■	■	■	■
Fuchsia (502)		■	■	■	■
Jet (280)		■	■	■	■
Jonquil (213)		■	■	■	■
Light Rose (223)		■	■	■	■
Light Siam (227)		■	■	■	■
Light Turquoise (263)		■	■	■	■
Peridot (214)		■	■	■	■
Rose Peach (262)		■	■	■	■
Tangerine (259)		■	■	■	■
Violet (371)		■	■	■	■
Crystal Blend Colors					
Amethyst Blend (721)		■	■	■	■
Provence Lavender-Chrysolite Blend (726)			■	■	■
Crystal Effects					
Transparent Effects					
Crystal AB (001 AB)		■	■	■	■
Crystal Astral Pink (001 API)		■	■	■	■
Crystal Copper (001 COP)		■	■	■	■
Crystal Golden Shadow (001 GSHA)		■	■	■	■
Crystal Silver Night (001 SINI)		■	■	■	■
Metallic Effects					
Crystal Iridescent Green (001 IRIG)		■	■	■	■
Crystal Metallic Light Gold 2x (001 MLG2)		■	■		

Beads

5900 (large hole)

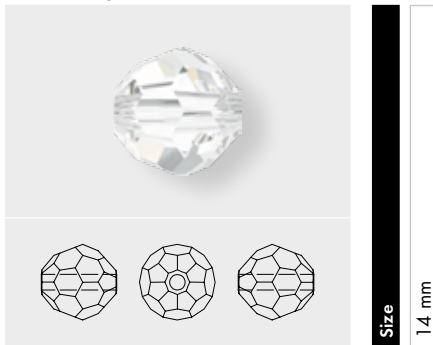

Size

14 mm

Crystal

Crystal (001)

Crystal Effects

Transparent Effects

Crystal AB (001 AB)

Crystal Blue Shade (001 BLSH)

Crystal Golden Shadow (001 GSHA)

5942 Heart Bead (large hole)

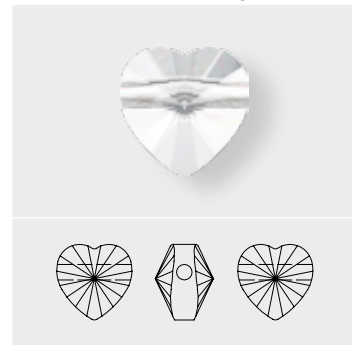

Size

14 mm

Crystal

Crystal (001)

Colors

Plain Colors

Jet (280)

Crystal Effects

Transparent Effects

Crystal AB (001 AB)

Crystal Bronze Shade (001 BRSH)

Crystal Red Magma (001 REDM)

ARTICLE EXPLANATION

40 512 Crystal Mesh Ball



S	12 mm	
M	12 PCS	100%

40 512	S	M	100%
Article Number	Size	Minimum Order Quantity in pieces (PCS)	Documentation size in %

EXPLANATION "COLOR COMBINATIONS"

All mentioned color combinations are preestablished in terms of

- Crystal color
- Crystal Pearl color
- Casing color

and are not modifiable. Within the available combinations you can choose from two different ring configurations.

ORDERING EXAMPLE & PRODUCT VARIETY EXPLANATION

40 512	082	001	001 650	0
Article number	Color of casing	Color of crystals	Color of Crystal Pearl	Ring configuration
		Please see the respective product matrix for available code reference	Please see the respective product matrix for available code reference	0 no jump ring 1 with 1 jump ring

AVAILABLE CRYSTAL MESH BALL COLORS & EFFECTS



Crystal F (001)

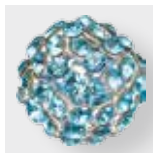

Aquamarine F (202)

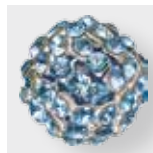

Denim Blue F (266)

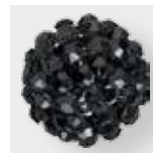

Jet (280)

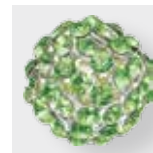

Peridot F (214)

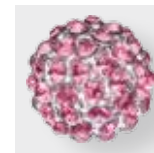

Rose F (209)



Smoky Quartz F (225)

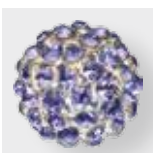

Tanzanite F (539)



Vintage Rose F (319)



Crystal Aurore Boreale F (001 AB)



Crystal Golden Shadow F (001 GSHA)



Crystal Luminous Green F (001 LUMG)



Crystal Silver Night (001 SINI)



Crystal Silver Shade F (001 SSHA)

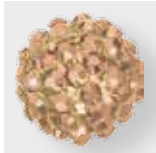

Crystal Rose Gold F
(001 ROGL)



Jet Hematite
(280 HEM)

AVAILABLE CRYSTAL MESH BALL MULTICOLORS

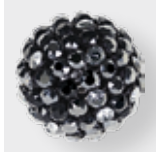

Black Multi (BKMU)

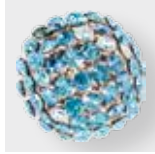

Blue Multi (BLMU)

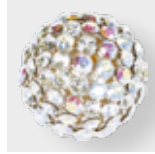

Crystal Multi (CRMU)

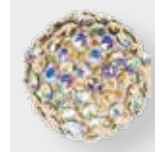

Light Silk Multi
(LSMU)

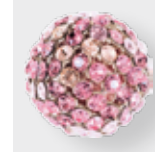

Light Rose Multi
(LRMU)

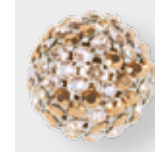

Silk Multi (SIMU)

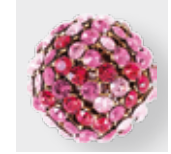

Rose Multi (ROMU)

AVAILABLE CRYSTAL MESH BALL DEGRADÉES

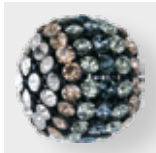

Black Degradée
(BKDE)

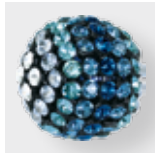

Blue Degradée (BLDE)



Silk Degradée (SIDE)

Beads

Crystal Mesh Ball

40 512 Crystal Mesh Ball

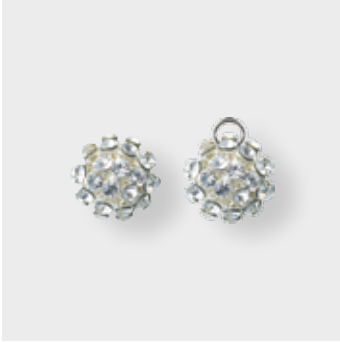

S	12 mm	
M	12 PCS	100%

40 515 Crystal Mesh Ball

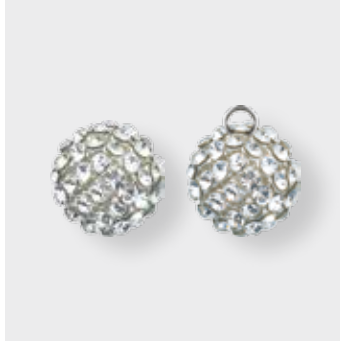

S	15 mm	
M	12 PCS	100%

40 519 Crystal Mesh Ball



S	19 mm	
M	6 PCS	100%

<p>40 512 40 515 40 519</p>	<p>Ring Configuration</p> <p>0 no jump ring*</p> <p>1 with 1 jump ring**</p>	<p>Sizes</p> <p>40 512 12 mm</p> <p>40 515 15 mm</p> <p>40 519 19 mm</p>				
<p>Crystal Combination</p> <ul style="list-style-type: none"> Crystal F (001) Crystal White Pearl (001 650) Casing Color: 082 Silver 						
<p>Color Combinations</p>						
<p>Plain Colors</p> <ul style="list-style-type: none"> Aquamarine F (202) Crystal Light Blue Pearl (001 302) Casing Color: 082 Silver Denim Blue F (266) Crystal Night Blue Pearl (001 818) Casing Color: 082 Silver Jet (280) Crystal Mystic Black Pearl (001 335) Casing Color: 012 Black Peridot F (214) Crystal Light Green Pearl (001 293) Casing Color: 082 Silver Rose F (209) Crystal Powder Rose Pearl (001 352) Casing Color: 082 Silver Smoky Quartz F (225) Crystal Deep Brown Pearl (001 414) Casing Color: 082 Silver Tanzanite F (539) Crystal Mauve Pearl (001 160) Casing Color: 082 Silver Vintage Rose F (319) Crystal Rosaline Pearl (001 294) Casing Color: 082 Silver 						

* The used thread enables a comfortable identification of the hole position and is not meant to be used for further application.

**The color of the jump ring is preestablished and can be seen in the article number. On special request the Crystal Mesh Ball can also be supplied with 2 jump rings.

		40 512			40 515			40 519		
		Ring Configuration			Sizes					
		0 no jump ring*			1 with 1 jump ring**					
		40 512 12 mm			40 515 15 mm			40 519 19 mm		
Crystal Effect Combinations										
Transparent Effects										
Crystal AB F (001 AB) Crystal White Pearl (001 650) Casing Color: 082 Silver		■	■	■	■	■	■	■	■	■
Crystal Golden Shadow F (001 GSHA) Crystal Vintage Gold Pearl (001 651) Casing Color: 082 Silver		■	■	■	■	■	■	■	■	■
Crystal Luminous Green F (001 LUMG) Crystal Gold Pearl (001 296) Casing Color: 081 Gold		■	■	■	■	■	■	■	■	■
Crystal Silver Night F (001 SINI) Crystal Dark Grey Pearl (001 617) Casing Color: 082 Silver		■	■	■	■	■	■	■	■	■
Crystal Silver Shade F (001 SSHA) Crystal Platinum Pearl (001 459) Casing Color: 082 Silver		■	■	■	■	■	■	■	■	■
Metallic Effects										
Crystal Rose Gold F (001 ROGL) Crystal Rose Gold Pearl (001 769) Casing Color: 081 Gold		■	■	■	■	■	■	■	■	■
Color Effect Combinations										
Metallic Effects										
Jet Hematite (280 HEM) Crystal Black Pearl (001 298) Casing Color: 012 Black		■	■	■	■	■	■	■	■	■

* The used thread enables a comfortable identification of the hole position and is not meant to be used for further application.

**The color of the jump ring is preestablished and can be seen in the article number. On special request the Crystal Mesh Ball can also be supplied with 2 jump rings.

	Ring Configuration	0 no jump ring*	1 with 1 jump ring**	Sizes	40 512 12 mm	40 515 15 mm	40 519 19 mm
<p>40 512 40 515 40 519</p>							
Multicolors							
<ul style="list-style-type: none"> Black Multi (BKMU)¹ Crystal Black Pearl (001 298) Casing Color: 012 Black 		■	■		■	■	■
<ul style="list-style-type: none"> Blue Multi (BLMU)² Crystal Light Grey Pearl (001 616) Casing Color: 082 Silver 		■	■		■	■	■
<ul style="list-style-type: none"> Crystal Multi (CRMU)³ Crystal Cream Pearl (001 620) Casing Color: 082 Silver 		■	■		■	■	■
<ul style="list-style-type: none"> Light Silk Multi (LSMU)⁴ Crystal Gold Pearl (001 296) Casing Color: 082 Silver 		■	■		■	■	■
<ul style="list-style-type: none"> Light Rose Multi (LRMU)⁵ Crystal Powder Rose Pearl (001 352) Casing Color: 082 Silver 		■	■		■	■	■
<ul style="list-style-type: none"> Silk Multi (SIMU)⁶ Crystal Rose Gold Pearl (001 769) Casing Color: 082 Silver 		■	■		■	■	■
<ul style="list-style-type: none"> Rose Multi (ROMU)⁷ Crystal Powder Rose Pearl (001 352) Casing Color: 081 Gold 		■	■		■	■	■
Degradées							
<ul style="list-style-type: none"> Black Degradée (BKDE)⁸ Crystal Black Pearl (001 298) Casing Color: 012 Black 		■	■				■
<ul style="list-style-type: none"> Blue Degradée (BLDE)⁹ Crystal Night Blue Pearl (001 818) Casing Color: 012 Black 		■	■				■
<ul style="list-style-type: none"> Silk Degradée (SIDE)¹⁰ Crystal Peach Pearl (001 300) Casing Color: 082 Silver 		■	■				■

* The used thread enables a comfortable identification of the hole position and is not meant to be used for further application.
 ** The color of the jump ring is preestablished and can be seen in the article number. On special request the Crystal Mesh Ball can also be supplied with 2 jump rings.

¹ Black Multi consists of Jet, Jet Hematite, Crystal Silver Night F.
² Blue Multi consists of Aquamarine F, Light Turquoise F, Crystal Blue Shade F.
³ Crystal Multi consists of Crystal F, Crystal Moonlight F, Crystal AB.
⁴ Light Silk Multi consists of Crystal AB F, Crystal Luminous Green F, Crystal Golden Shadow F.
⁵ Light Rose Multi consists of Crystal Antique Pink F, Light Rose F, Vintage Rose F.
⁶ Silk Multi consists of Silk F, Crystal Rose Gold, Light Silk F.
⁷ Rose Multi consists of Light Rose F, Rose F, Indian Pink F.
⁸ Black Degradée consists of Crystal, Crystal Silver Shade, Greige, Black Diamond, Crystal Silver Night.
⁹ Blue Degradée consists of Crystal, Crystal Blue Shade, Indian Sapphire, Denim Blue, Montana.
¹⁰ Silk Degradée consists of Crystal, Light Silk, Silk, Light Peach, Vintage Rose.

COMPLEMENTARY PRODUCTS

These protective plastic spacer rings are recommended for the use in between Beads, as they facilitate the longevity of the designs and enable the utilisation of larger sized Beads and complex cuts. Please order art. 7800 Nr. 646 with Sys.no. 977980 (packing unit = 100 pcs) and art. 7800 Nr. 647 with Sys.no. 977981 (packing unit = 1,000 pcs).

7800 Protective Spacer Rings

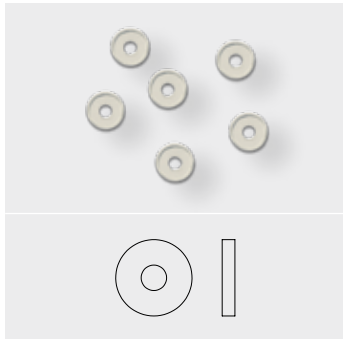

C	Transparent	
S	3 mm (hole 1 mm)	
M	100 PCS (Nr. 646)	
	1,000 PCS (Nr. 647)	150%

Beads

04 Beads

PRODUCT DETAILS

Article Size	Packing Unit = Minimum Order Quantity in Pieces	Average Net Weight in Gram per Packing Unit Crystal (001)	Average Gross Weight in Gram per Packing Unit Crystal (001)
5000			
2 mm	1,440	11.5	20.8
3 mm	720	23.6	33.4
4 mm	720	53.5	62.6
5 mm	720	105.3	116.3
6 mm	360	81.6	92.5
7 mm	288	126.2	159.2
8 mm	288	193.5	200.8
10 mm	144	180.6	199.4
12 mm	72	144.2	166.1
14 mm	72	247.1	280.5
16 mm	48	252.3	296.6
18 mm	24	168.7	185.9
20 mm	12	123.5	142.9
5003			
6 mm	360	109.9	120.8
8 mm	144	100.4	118.6
10 mm	144	195.9	219.2
12 mm	72	158.5	179.2
14 mm	48	172.4	193.0
5005			
8 mm	216	145.4	172.1
12 mm	72	154.3	175.4
16 mm	24	122.1	146.7
5020			
6 mm	360	74.5	85.2
8 mm	288	146.6	178.2
10 mm	144	116.4	139.2
5026			
6 mm	288	71.905	81.052
8 mm	144	72.576	98.340
10 mm	96	99.348	120.476
5028/4			
6 mm	360	75.791	83.435
8 mm	144	74.714	85.634
10 mm	72	70.763	76.467
5040			
4 mm	720	41.3	50.4
6 mm	360	71.8	82.9
8 mm	288	135.6	163.7
12 mm	144	214.4	242.4
18 mm	24	121.4	140.2
5041			
18 mm	24	114.2	133.0
5050			
14x10 mm	72	66.29	86.67
22x16 mm	36	90.40	115.60
5051			
8x6 mm	288	67.249	76.379
10x8 mm	144	50.803	74.903
5052			
6 mm	288	49.728	48.859
8 mm	144	42.336	65.831

Beads

Article Size	Packing Unit = Minimum Order Quantity in Pieces	Average Net Weight in Gram per Packing Unit Crystal (001)	Average Gross Weight in Gram per Packing Unit Crystal (001)
5053			
6 mm	288	49.728	58.859
8 mm	144	54.432	71.820
5054			
6 mm	288	39.997	49.145
8 mm	144	43.344	64.428
5055			
8x6 mm	144	39.476	60.476
10x8 mm	72	32.844	49.661
5056			
10x6 mm	144	41.731	62.731
12x8 mm	96	45.965	67.049
5139			
12.5 mm	48	44.6	61.8
5181			
13x7 mm	144	72.3	94.6
17x9 mm	48	52.2	72.2
5200			
6x4 mm	360	44.1	53.2
7.5x5 mm	360	80.0	91.0
5203			
12x8 mm	144	82.7	106.2
5305			
5 mm	720	52.7	63.9
6 mm	360	50.5	61.4
5308			
6 mm	360	54.4	65.4
5328			
2.5 mm	1,440	23.8	31.4
3 mm	1,440	34.1	45.2
4 mm	1,440	81.8	89.2
5 mm	720	89.3	100.0
6 mm	360	73.7	84.6
8 mm	288	141.8	173.4
10 mm	144	140.4	154.0
5500			
9x6 mm	144	59.0	69.9
10.5x7 mm	144	88.8	109.6
12x8 mm	144	144.0	164.1
5520			
12 mm	144	154.4	178.9
5523			
12 mm	144	143.2	173.6
16 mm	72	156.1	194.7
5535			
19x5 mm	72	60.26	85.54
23.5x5 mm	48	54.48	79.29
5540			
12 mm	72	62.1	86.7
17 mm	48	108.9	133.5

Beads

Article Size	Packing Unit = Minimum Order Quantity in Pieces	Average Net Weight in Gram per Packing Unit Crystal (001)	Average Gross Weight in Gram per Packing Unit Crystal (001)
5541			
11 mm	96	105.638	129.266
15 mm	48	126.202	146.241
5542			
8 mm	96	81.446	102.897
11 mm	48	97.574	118.581
5601			
4 mm	288	43.9	65.2
6 mm	144	70.6	88.9
8 mm	96	100.2	118.4
10 mm	72	138.0	156.5
12 mm	36	129.6	147.7
5603			
8 mm	144	119.3	138.6
10 mm	96	179.1	205.9
5621			
14 mm	96	168.7	202.1
18 mm	72	253.1	283.8
5624			
10 mm	108	117.51	134.15
14 mm	72	174.77	204.50
5625			
10 mm	108	108.86	127.0
5650			
12x8 mm	144	108.1	131.9
16x10 mm	72	138.0	153.9
5714			
8 mm	288	73.3	102.1
12 mm	108	72.3	102.2
5727			
14 mm	108	72.3	105.4
5742			
8 mm	288	120.5	154.5
10 mm	288	233.1	266.5
5743			
12 mm	108	72.23	96.96
17 mm	72	122.58	134.82
5744			
6 mm	360	47.4	58.1
8 mm	288	80.2	112.3
5747			
12x6 mm	144	64.35	81.17
16x8 mm	96	104.75	124.44
5750			
13 mm	12	24.192	43.798
19 mm	12	73.715	99.990
5752			
8 mm	288	106.06	136.88
12 mm	96	117.74	137.49

Beads

Article Size	Packing Unit = Minimum Order Quantity in Pieces	Average Net Weight in Gram per Packing Unit Crystal (001)	Average Gross Weight in Gram per Packing Unit Crystal (001)
5754			
6 mm	360	42.3	53.0
8 mm	288	77.9	109.8
10 mm	288	156.9	188.9
12 mm	144	136.7	168.9
5900			
14 mm	48	137.28	146.98
5942			
14 mm	48	103.25	130.56
40 512			
12 mm	12	25.4	42.8
40 515			
15 mm	12	45.4	61.6
40 519			
19 mm	6	45.1	62.2
7800			
Nr. 646	100	-	-
Nr. 647	1,000	-	-