

Flat Backs No Hotfix

Flat Backs No Hotfix are loose crystal elements backed with platinum foiling for extra brilliance and protection. These Flat Backs are easy to apply to a variety of carrier materials using standard one- or two-component glues. They are available in a multitude of sizes, colors, shapes and cuts.

The most innovative single item in this product group is art. 2088 XIRIUS Rose, with its most progressive and unique cut in the market: multilayer cut technology creates the inspiring XIRIUS star design. Superior fire and a rich, well balanced cloud of light points redefine the market standard.

Swarovski's outstanding quality standards of crystal elements are underlined by highest precision in table size and diameter.

COLORS & EFFECTS

Colors



Crystal
001



White Opal
234



Light Silk
261



Silk
391



Light Peach
362



Vintage Rose
319



Light Rose
223



Rose Peach
262

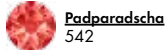

Padparadscha
542



Indian Pink
289



Sun
248



Fireopal*
237



Hyacinth
236



Light Siam
227



Indian Siam*
327



Rose
209



Fuchsia
502



Ruby
501



Siam
208



Burgundy
515



Amethyst
204

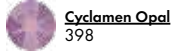

Cyclamen Opal
398



Purple Velvet
277



Cobalt
369



Tanzanite
539



Light Amethyst
212



Provence Lavender
283



Light Sapphire
211



Aquamarine
202



Air Blue Opal
285



Sapphire
206



Capri Blue
243



Dark Indigo
288



Montana
207



Caribbean Blue Opal
394



Light Turquoise
263



Blue Zircon
229



Denim Blue
266



Black Diamond
215



Pacific Opal
390



Chrysolite Opal
294



Chrysolite
238



Peridot
214



Erinite
360



Fern Green
291



Dark Moss Green
260



Emerald
205



Olivine
228



Khaki
550



Greige
284



Light Colorado Topaz
246



Jonquil
213



Citrine
249



Light Topaz
226



Sunflower
292



Topaz
203



Tangerine
259



Smoked Topaz
220



Mocca
286



Jet**
280

Ceramics



Marbled Light Grey
657



Marbled Terracotta
655



Marbled Yellow
652



Marbled Blue
654



Marbled Black
653

Effects



Crystal Silver Shade
001 SSHA



Crystal Moonlight
001 MOL



Crystal Aurore Boreale
001 AB



Crystal Luminous Green***
001 LUMG



Crystal Golden Shadow
001 GSHA



Crystal Rose Gold
001 ROGL



Crystal Copper***
001 COP



Crystal Astral Pink
001 API



Light Siam Aurore Boreale
227 AB



Crystal Red Magma***
001 REDM



Light Rose Aurore Boreale
223 AB



Crystal Antique Pink
001 ANTP



Rose Aurore Boreale
209 AB



Crystal Volcano
001 VOL



Crystal Lilac Shadow
001 LISH



Sapphire Aurore Boreale
206 AB



Crystal Metallic Blue***
001 METBL



Crystal Meridian Blue
001 MBL



Aquamarine Aurore Boreale
202 AB



Crystal Blue Shade
001 BLSH



Peridot Aurore Boreale
214 AB



Jonquil Aurore Boreale
213 AB



Crystal Iridescent Green
001 IRIG



Crystal Dorado***
001 DOR



Crystal Metallic Light Gold***
001 MLGID



Crystal Bronze Shade***
001 BRSH



Topaz Aurore Boreale
203 AB



Crystal Silver Night
001 SINI



Jet Nut***
280 NUT



Crystal Cosmojet*
001 COS



Jet Hematite**/**
280 HEM

Numerical Order

001	Crystal	203	Topaz	229	Blue Zircon	289	Indian Pink
001 AB	Crystal Aurore Boreale	203 AB	Topaz Aurore Boreale	234	White Opal	291	<u>Fern Green</u>
001 ANTP	<u>Crystal Antique Pink</u>	204	Amethyst	236	Hyacinth	292	<u>Sunflower</u>
001 API	<u>Crystal Astral Pink</u>	205	Emerald	237	<u>Fireopal*</u>	294	<u>Chrysolite Opal</u>
001 BLSH	<u>Crystal Blue Shade</u>	206	Sapphire	238	Chrysolite	319	<u>Vintage Rose</u>
001 BRSH	<u>Crystal Bronze Shade***</u>	206 AB	Sapphire Aurore Boreale	243	Capri Blue	327	<u>Indian Siam*</u>
001 COP	<u>Crystal Copper***</u>	207	Montana	246	Light Colorado Topaz	360	<u>Erinite</u>
001 COS	<u>Crystal Cosmojet*</u>	208	Siam	248	Sun	362	Light Peach
001 DOR	<u>Crystal Dorado***</u>	209	Rose	249	Citrine	369	Cobalt
001 GSHA	<u>Crystal Golden Shadow</u>	209 AB	Rose Aurore Boreale	259	<u>Tangerine</u>	390	<u>Pacific Opal</u>
001 IRIG	<u>Crystal Iridescent Green</u>	211	Light Sapphire	260	<u>Dark Moss Green</u>	391	Silk
001 LISH	<u>Crystal Lilac Shadow</u>	212	Light Amethyst	261	<u>Light Silk</u>	394	<u>Caribbean Blue Opal</u>
001 LUMG	<u>Crystal Luminous Green***</u>	213	Jonquil	262	<u>Rose Peach</u>	398	<u>Cyclamen Opal</u>
001 MBL	<u>Crystal Meridian Blue</u>	213 AB	Jonquil Aurore Boreale	263	Light Turquoise	501	Ruby
001 METBL	<u>Crystal Metallic Blue***</u>	214	Peridot	266	<u>Denim Blue</u>	502	Fuchsia
001 MLGLD	<u>Crystal Metallic Light Gold***</u>	214 AB	Peridot Aurore Boreale	277	Purple Velvet	515	Burgundy
001 MOL	Crystal Moonlight	215	Black Diamond	280	Jet**	539	Tanzanite
001 REDM	<u>Crystal Red Magma***</u>	220	Smoked Topaz	280 HEM	Jet Hematite**/**	542	<u>Padparadscha</u>
001 ROGL	<u>Crystal Rose Gold</u>	223	Light Rose	280 NUT	Jet Nut***	550	Khaki
001 SINI	<u>Crystal Silver Night</u>	223 AB	Light Rose Aurore Boreale	283	Provence Lavender	652	<u>Marbled Yellow</u>
001 SSHA	<u>Crystal Silver Shade</u>	226	Light Topaz	284	<u>Greige</u>	653	<u>Marbled Black</u>
001 VOL	Crystal Volcano	227	Light Siam	285	<u>Air Blue Opal</u>	654	<u>Marbled Blue</u>
202	Aquamarine	227 AB	Light Siam Aurore Boreale	286	<u>Mocca</u>	655	<u>Marbled Terracotta</u>
202 AB	Aquamarine Aurore Boreale	228	Olivine	288	<u>Dark Indigo</u>	657	<u>Marbled Light Grey</u>

Alphabetical Order

<u>Air Blue Opal (285)</u>	<u>Crystal Lilac Shadow (001 LISH)</u>	Jet (280)**	Olivine (228)
Amethyst (204)	<u>Crystal Luminous Green (001 LUMG)***</u>	Jet Hematite (280 HEM)**/**	<u>Pacific Opal (390)</u>
Aquamarine (202)	<u>Crystal Meridian Blue (001 MBL)</u>	Jet Nut (280 NUT)***	<u>Padparadscha (542)</u>
Aquamarine Aurore Boreale (202 AB)	<u>Crystal Metallic Blue (001 METBL)***</u>	Jonquil (213)	Peridot (214)
Black Diamond (215)	<u>Crystal Metallic Light Gold (001 MLGLD)***</u>	Jonquil Aurore Boreale (213 AB)	Peridot Aurore Boreale (214 AB)
Blue Zircon (229)	<u>Crystal Moonlight (001 MOL)</u>	Khaki (550)	Provence Lavender (283)
Burgundy (515)	<u>Crystal Red Magma (001 REDM)***</u>	Light Amethyst (212)	Purple Velvet (277)
Capri Blue (243)	<u>Crystal Rose Gold (001 ROGL)</u>	Light Colorado Topaz (246)	Rose (209)
<u>Caribbean Blue Opal (394)</u>	<u>Crystal Silver Night (001 SINI)</u>	Light Peach (362)	Rose Aurore Boreale (209 AB)
Chrysolite (238)	<u>Crystal Silver Shade (001 SSHA)</u>	Light Rose (223)	<u>Rose Peach (262)</u>
<u>Chrysolite Opal (294)</u>	<u>Crystal Volcano (001 VOL)</u>	Light Rose Aurore Boreale (223 AB)	Ruby (501)
Citrine (249)	<u>Cyclamen Opal (398)</u>	Light Sapphire (211)	Sapphire (206)
Cobalt (369)	<u>Dark Indigo (288)</u>	Light Siam (227)	Sapphire Aurore Boreale (206 AB)
Crystal (001)	<u>Dark Moss Green (260)</u>	Light Siam Aurore Boreale (227 AB)	Siam (208)
<u>Crystal Antique Pink (001 ANTP)</u>	<u>Denim Blue (266)</u>	<u>Light Silk (261)</u>	Silk (391)
<u>Crystal Astral Pink (001 API)</u>	Emerald (205)	Light Topaz (226)	Smoked Topaz (220)
Crystal Aurore Boreale (001 AB)	<u>Erinite (360)</u>	Light Turquoise (263)	Sun (248)
<u>Crystal Blue Shade (001 BLSH)</u>	<u>Fern Green (291)</u>	<u>Marbled Black (653)</u>	<u>Sunflower (292)</u>
<u>Crystal Bronze Shade (001 BRSH)***</u>	<u>Fireopal (237)*</u>	<u>Marbled Blue (654)</u>	<u>Tangerine (259)</u>
<u>Crystal Copper (001 COP)***</u>	Fuchsia (502)	<u>Marbled Light Grey (657)</u>	Tanzanite (539)
<u>Crystal Cosmojet (001 COS)*</u>	<u>Greige (284)</u>	<u>Marbled Terracotta (655)</u>	Topaz (203)
Crystal Dorado (001 DOR)***	Hyacinth (236)	<u>Marbled Yellow (652)</u>	Topaz Aurore Boreale (203 AB)
<u>Crystal Golden Shadow (001 GSHA)</u>	Indian Pink (289)	<u>Mocca (286)</u>	<u>Vintage Rose (319)</u>
<u>Crystal Iridescent Green (001 IRIG)</u>	<u>Indian Siam* (327)</u>	Montana (207)	White Opal (234)

This color chart is valid for the product group Flat Backs No Hotfix.

The displayed assortment is not entirely available for all products within the product group. For details on available colors and effects, please see the product matrix for the respective item.

Classic Colors: This color range offers a wide choice of traditional Swarovski crystal colors.
Exclusive Colors: This color range is offered exclusively by Swarovski.

The standard assortment of colors and effects may vary according to the product group.

Slight changes in shades are unavoidable. Colors may vary according to cut and shape.



































































* Only available in limited sizes.

** In these colors art. 2088 is available as foiled or unfoiled version.

***Crystals are not resistant to plating and similar processing.

Flat Backs No Hotfix

SUMMARY

1 	2 	2000 SS 3, 4	1 	2 	2483 10, 25 mm	1 	2 	2788 8, 10, 14 mm
		2006 10, 12, 14, 16 mm			2493 8, 10, 12, 20, 30 mm			2797 8x4, 10x5 mm
		2035 6, 10, 14, 20, 30, 40 mm			2520 8x6, 10x8, 14x10 mm			2808 6, 10, 14 mm
		2037 8, 14, 17 mm			2555 8x2.6, 12x4, 15x5 mm			2816 5 mm
		2058 SS 5, 6, 7, 8, 9, 10 mm			2570 50x16 mm			2826 5 mm
		2058/B SS 7, 9, 12, 16, 20			2585 8, 10, 14 mm			2854 8, 12, 18 mm
		2072 8, 10, 12 mm			2611 8, 10, 14 mm			2858 6x4.5, 9x6.5, 12x8.5 mm
		2088 SS 12, 14, 16, 20, 30, 34, 40, 48			2611/G 8, 10, 14 mm			
		2200 8x4 mm			2708 8x8.7, 12.5x13.6 mm			
		2204 6x4.8, 10x8, 14x11 mm			2709 10x6, 13x8 mm			
		2300 8x4.8, 10x6 mm			2716 5 mm			
		2400 3, 4, 6 mm			2720 7.5, 9, 12.5 mm			
		2420 10, 25 mm			2770 6x3.5, 12x7 mm			

1 Top view 2 Side view

• The logo position is marked with a red dot.

Flat Backs No Hotfix

2000 Rose Flat Back

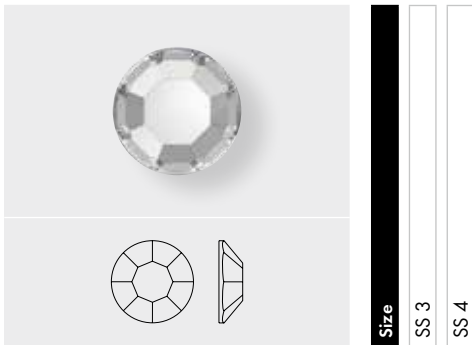

Size
SS 3
SS 4

Crystal

Crystal F (001)

Colors

Plain Colors

Amethyst F (204)

Aquamarine F (202)

Black Diamond F (215)

Indian Siam F (327)

Jet (280)

Jonquil F (213)

Light Colorado Topaz F (246)

Light Rose F (223)

Montana F (207)

Peridot F (214)

Smoked Topaz F (220)

Crystal Effects

Transparent Effects

Crystal AB F (001 AB)

Crystal Golden Shadow F (001 GSHA)

Crystal Silver Shade F (001 SSHA)

Metallic Effects

Crystal Metallic Blue F (001 METBL)

Crystal Metallic Light Gold F (001 MLGLD)

Crystal Rose Gold F (001 ROGL)

Color Effects

Metallic Effects

Jet Hematite (280 HEM)

2006 Rivoli Flat Back

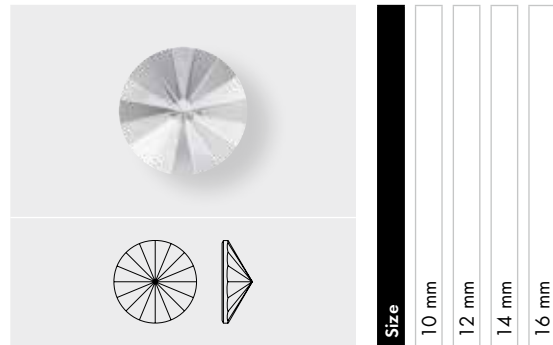

Size
10 mm
12 mm
14 mm
16 mm

Crystal

Crystal F (001)

Flat Backs No Hotfix

2035 Chessboard Circle Flat Back

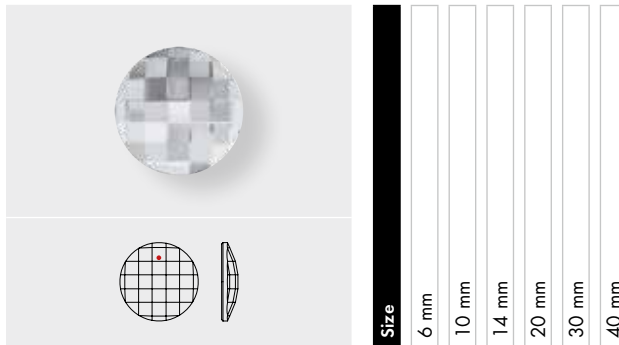

Crystal	6 mm	10 mm	14 mm	20 mm	30 mm	40 mm
Crystal F (001)	■	■	■	■	■	■
Crystal CAL SI (001 CAL SI) ¹⁾⁺²⁾				■		
Crystal CAL V SI (001 CAL V SI) ¹⁾				■	■	■
Colors						
Plain Colors						
Aquamarine F (202)	■	■	■			
Black Diamond F (215)	■	■	■	■		
Jet (280)	■	■	■	■		
Crystal Effects						
Transparent Effects						
Crystal AB F (001 AB)	■	■				
Crystal Antique Pink F (001 ANTP)	■	■				
Crystal Golden Shadow F (001 GSHA)	■	■	■	■		
Crystal Red Magma F (001 REDM)	■	■	■			

2037 Eclipse Flat Back

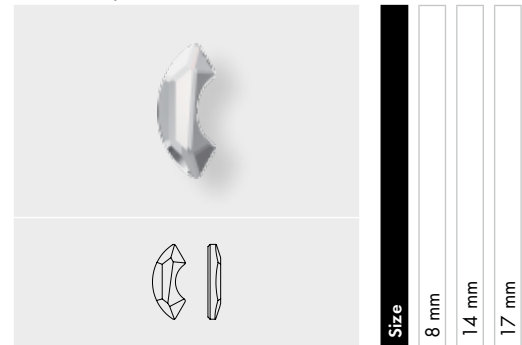

Crystal	8 mm	14 mm	17 mm
Crystal F (001)	■	■	■

¹⁾ Integrated articles of the former Bath & Wellness Collection may be partly delivered with a laser-engraved logo.

● The logo position is marked with a red dot.

²⁾ Coated on faceted side.

Flat Backs No Hotfix

2058 XILION Rose Enhanced

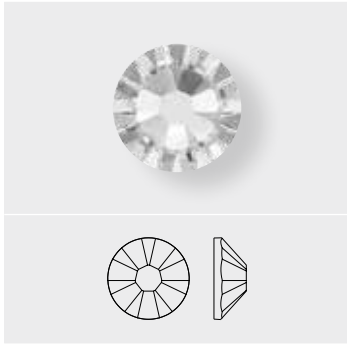

Size	SS 5	SS 6	SS 7	SS 8	SS 9	SS 10
------	------	------	------	------	------	-------

Crystal

Crystal F (001)	■	■	■	■	■	■
-----------------	---	---	---	---	---	---

Colors

Plain Colors

Amethyst F (204)	■	■	■		■	■
Aquamarine F (202)	■	■	■		■	■
Black Diamond F (215)	■	■	■	■	■	■
Blue Zircon F (229)	■	■	■		■	■
Burgundy F (515)	■		■		■	
Capri Blue F (243)	■	■	■		■	■
Chrysolite F (238)	■		■		■	
Citrine F (249)	■	■	■		■	■
Cobalt F (369)	■		■		■	
Dark Indigo F (288)	■		■		■	
Dark Moss Green F (260)	■		■		■	
Denim Blue F (266)	■		■		■	
Emerald F (205)	■	■	■		■	■
Erinite F (360)	■		■		■	
Fern Green F (291)	■		■		■	
Fuchsia F (502)	■	■	■		■	■
Greige F (284)	■		■		■	
Hyacinth F (236)	■	■	■		■	■
Indian Pink F (289)	■		■		■	
Indian Siam F (327)	■		■		■	
Jet (280)	■	■	■	■	■	■
Jet F (280)	■	■	■	■	■	■
Jonquil F (213)	■	■	■		■	■
Light Amethyst F (212)	■	■	■		■	■
Light Colorado Topaz F (246)	■	■	■	■	■	■
Light Peach F (362)	■		■		■	
Light Rose F (223)	■	■	■	■	■	■
Light Sapphire F (211)	■	■	■		■	■
Light Siam F (227)	■	■	■	■	■	■
Light Silk F (261)	■		■		■	
Light Topaz F (226)	■		■		■	
Light Turquoise F (263)	■		■		■	
Mocca F (286)	■		■		■	
Montana F (207)	■	■	■		■	■
Olivine F (228)	■		■		■	
Padparadscha F (542)	■		■		■	
Peridot F (214)	■	■	■		■	■

08 Flat Backs No Hotfix

Flat Backs No Hotfix

2058		Size	SS 5	SS 6	SS 7	SS 8	SS 9	SS 10
Provence Lavender F (283)			■		■		■	
Purple Velvet F (277)			■		■		■	
Rose F (209)			■	■	■	■	■	■
Rose Peach F (262)			■		■		■	
Ruby F (501)			■	■	■		■	■
Sapphire F (206)			■	■	■		■	■
Siam F (208)			■	■	■		■	■
Silk F (391)			■		■		■	
Smoked Topaz F (220)			■	■	■		■	■
Sun F (248)			■	■	■		■	■
Sunflower F (292)			■		■		■	
Tangerine F (259)			■		■		■	
Tanzanite F (539)			■	■	■		■	■
Topaz F (203)			■	■	■		■	■
Vintage Rose F (319)			■		■		■	
Opal Colors								
Air Blue Opal F (285)			■		■		■	
Caribbean Blue Opal F (394)			■		■		■	
Chrysolite Opal F (294)			■		■		■	
Cyclamen Opal F (398)			■		■		■	
Pacific Opal F (390)			■		■		■	
White Opal F (234)			■		■		■	
Crystal Effects								
Transparent Effects								
Crystal AB F (001 AB)			■	■	■	■	■	■
Crystal Antique Pink F (001 ANTP)			■		■		■	
Crystal Blue Shade F (001 BLSH)			■		■		■	
Crystal Bronze Shade F (001 BRSH)			■		■		■	
Crystal Copper F (001 COP)			■		■		■	
Crystal Cosmojet F (001 COS)			■		■		■	
Crystal Golden Shadow F (001 GSHA)			■		■		■	
Crystal Lilac Shadow F (001 LISH)			■		■		■	
Crystal Luminous Green F (001 LUMG)			■		■		■	
Crystal Meridian Blue F (001 MBL)			■		■		■	
Crystal Moonlight F (001 MOL)			■		■		■	
Crystal Red Magma F (001 REDM)			■		■		■	
Crystal Silver Night F (001 SINI)			■		■		■	
Crystal Silver Shade F (001 SSHA)			■		■		■	
Crystal Volcano F (001 VOL)			■	■	■		■	■
Metallic Effects								
Crystal Dorado F (001 DOR)			■		■		■	

Flat Backs No Hotfix

08 Flat Backs No Hotfix

2058		Size	SS 5	SS 6	SS 7	SS 8	SS 9	SS 10
	Crystal Iridescent Green F (001 IRIG)		■		■		■	
	Crystal Metallic Blue F (001 METBL)		■		■		■	
	Crystal Metallic Light Gold F (001 MLGLD)		■		■		■	
	Crystal Rose Gold F (001 ROGL)		■		■		■	
Color Effects								
Transparent Effects								
	Aquamarine AB F (202 AB)		■		■		■	
	Jonquil AB F (213 AB)		■		■		■	
	Light Rose AB F (223 AB)		■		■		■	
	Light Siam AB F (227 AB)		■		■		■	
	Peridot AB F (214 AB)		■		■		■	
	Rose AB F (209 AB)		■		■		■	
	Sapphire AB F (206 AB)		■		■		■	
	Topaz AB F (203 AB)		■		■		■	
Metallic Effects								
	Jet Hematite (280 HEM)		■	■	■		■	■
	Jet Hematite F (280 HEM)		■	■	■		■	■
	Jet Nut F (280 NUT)		■		■		■	

2058/B XILION Rose Flat Back

2058/B XILION Rose Flat Back		Size	SS 7	SS 9	SS 12	SS 16	SS 20
	Marbled Black (653)		■	■	■	■	■
	Marbled Blue (654)		■	■	■	■	■
	Marbled Light Grey (657)		■	■	■	■	■
	Marbled Terracotta (655)		■	■	■	■	■
	Marbled Yellow (652)		■	■	■	■	■

2072 Rose Cut Flat Back

2072 Rose Cut Flat Back		Size	8 mm	10 mm	12 mm
	Crystal F (001)		■	■	■
Colors					
Plain Colors					
	Jet (280)		■	■	

Flat Backs No Hotfix

2088 XIRIUS Rose

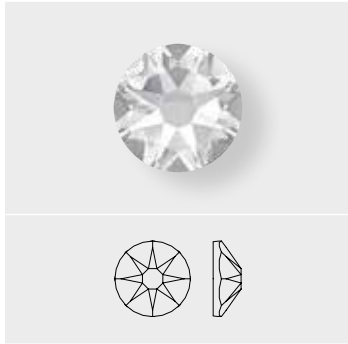

	SS 12	SS 14	SS 16	SS 20	SS 30	SS 34	SS 40	SS 48
Crystal								
Crystal F (001)	■	■	■	■	■	■	■	■
Colors								
Plain Colors								
Amethyst F (204)	■		■	■	■	■		
Aquamarine F (202)	■		■	■	■	■		
Black Diamond F (215)	■	■		■	■	■		
Blue Zircon F (229)	■		■	■	■	■		
Burgundy F (515)	■		■	■	■	■		
Capri Blue F (243)	■		■	■	■	■		
Chrysolite F (238)	■		■	■	■	■		
Citrine F (249)	■		■	■	■	■		
Cobalt F (369)	■		■	■	■	■		
Dark Indigo F (288)	■		■	■	■	■		
Dark Moss Green F (260)	■		■	■	■	■		
Denim Blue F (266)	■		■	■	■	■		
Emerald F (205)	■		■	■	■	■		
Erinite F (360)	■		■	■	■	■		
Fern Green F (291)	■		■	■	■	■		
Fireopal F (237)	■		■	■	■	■		
Fuchsia F (502)	■		■	■	■	■		
Greige F (284)	■		■	■	■	■		
Hyacinth F (236)	■		■	■	■	■		
Indian Pink F (289)	■		■	■	■	■		
Indian Siam F (327)	■		■	■	■	■		
Jet (280)	■	■		■	■	■		
Jet F (280)	■	■		■	■	■		
Jonquil F (213)	■		■	■	■	■		
Light Amethyst F (212)	■		■	■	■	■		
Light Colorado Topaz F (246)	■	■		■	■	■		
Light Peach F (362)	■		■	■	■	■		
Light Rose F (223)	■		■	■	■	■		
Light Sapphire F (211)	■		■	■	■	■		
Light Siam F (227)	■	■		■	■	■		
Light Silk F (261)	■		■	■	■	■		
Light Topaz F (226)	■		■	■	■	■		
Light Turquoise F (263)	■		■	■	■	■		
Mocca F (286)	■		■	■	■	■		
Montana F (207)	■		■	■	■	■		
Olivine F (228)	■		■	■	■	■		
Padparadscha F (542)	■		■	■	■	■		

Flat Backs No Hotfix

08 Flat Backs No Hotfix

2088		Size	SS 12	SS 14	SS 16	SS 20	SS 30	SS 34	SS 40	SS 48
Peridot F (214)			■		■	■	■	■		
Provence Lavender F (283)			■		■	■	■			
Purple Velvet F (277)			■		■	■	■	■		
Rose F (209)			■		■	■	■	■		
Rose Peach F (262)			■		■	■	■	■		
Ruby F (501)			■		■	■	■	■		
Sapphire F (206)			■		■	■	■	■		
Siam F (208)			■		■	■	■	■		
Silk F (391)			■		■	■	■	■		
Smoked Topaz F (220)			■		■	■	■	■		
Sun F (248)			■		■	■	■	■		
Sunflower F (292)			■		■	■	■	■		
Tangerine F (259)			■		■	■	■	■		
Tanzanite F (539)			■	■	■	■	■	■		
Topaz F (203)			■	■	■	■	■	■		
Vintage Rose F (319)			■		■	■	■	■		
Opal Colors										
Air Blue Opal F (285)			■		■	■	■	■		
Caribbean Blue Opal F (394)			■		■	■	■	■		
Chrysolite Opal F (294)			■		■	■	■			
Cyclamen Opal F (398)			■		■	■	■	■		
Pacific Opal F (390)			■		■	■	■	■		
White Opal F (234)			■		■	■	■	■		
Crystal Effects										
Transparent Effects										
Crystal AB F (001 AB)			■	■	■	■	■	■	■	■
Crystal Antique Pink F (001 ANTP)			■		■	■	■	■		
Crystal Blue Shade F (001 BLSH)			■		■	■	■	■		
Crystal Bronze Shade F (001 BRSH)			■		■	■	■			
Crystal Copper F (001 COP)			■		■	■	■	■		
Crystal Cosmojet F (001 COS)			■		■	■	■			
Crystal Golden Shadow F (001 GSHA)			■		■	■	■	■		
Crystal Lilac Shadow F (001 LISH)			■		■	■	■	■		
Crystal Luminous Green F (001 LUMG)			■		■	■	■	■		
Crystal Meridian Blue F (001 MBL)			■		■	■	■			
Crystal Moonlight F (001 MOL)			■		■	■	■	■		
Crystal Red Magma F (001 REDM)			■		■	■	■	■		
Crystal Silver Night F (001 SINI)			■		■	■	■	■		
Crystal Silver Shade F (001 SSHA)			■		■	■	■	■		
Crystal Volcano F (001 VOL)			■		■	■				

Flat Backs No Hotfix

2088		Size	SS 12	SS 14	SS 16	SS 20	SS 30	SS 34	SS 40	SS 48
Metallic Effects										
	Crystal Dorado F (001 DOR)		■		■	■	■	■		
	Crystal Iridescent Green F (001 IRIG)		■		■	■	■	■		
	Crystal Metallic Blue F (001 METBL)		■		■	■	■	■		
	Crystal Metallic Light Gold F (001 MLGLD)		■		■	■	■	■		
	Crystal Rose Gold F (001 ROGL)		■		■	■	■	■		
Color Effects										
Transparent Effects										
	Aquamarine AB F (202 AB)		■		■	■	■			
	Jonquil AB F (213 AB)		■		■	■	■			
	Light Rose AB F (223 AB)		■		■	■	■			
	Light Siam AB F (227 AB)		■		■	■	■			
	Peridot AB F (214 AB)		■		■	■	■			
	Rose AB F (209 AB)		■		■	■	■			
	Sapphire AB F (206 AB)		■		■	■	■			
	Topaz AB F (203 AB)		■		■	■	■			
Metallic Effects										
	Jet Hematite (280 HEM)		■		■	■	■	■		
	Jet Hematite F (280 HEM)		■		■	■	■	■		
	Jet Nut F (280 NUT)		■		■	■	■			

2200 Navette Flat Back

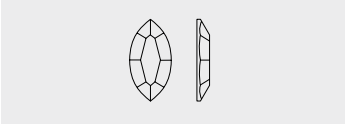
2200 Navette Flat Back		Size
 		8x4 mm
Crystal		
	Crystal F (001)	■

Flat Backs No Hotfix

2204 Pure Leaf Flat Back

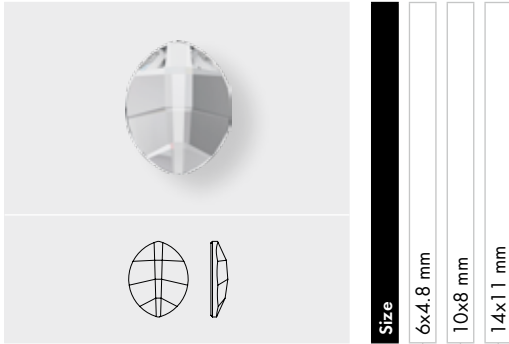

Size	6x4.8 mm	10x8 mm	14x11 mm
------	----------	---------	----------

Crystal

Crystal F (001)

Colors

Plain Colors

Amethyst F (204)

Dark Moss Green F (260)

Emerald F (205)

Jet (280)

Light Siam F (227)

Peridot F (214)

Crystal Effects

Transparent Effects

Crystal AB F (001 AB)

Crystal Blue Shade F (001 BLSH)

Crystal Golden Shadow F (001 GSHA)

Crystal Luminous Green F (001 LUMG)

Crystal Silver Night F (001 SINI)

2300 Drop Flat Back



Size	8x4.8 mm	10x6 mm
------	----------	---------

Crystal

Crystal F (001)

2400 Square Flat Back

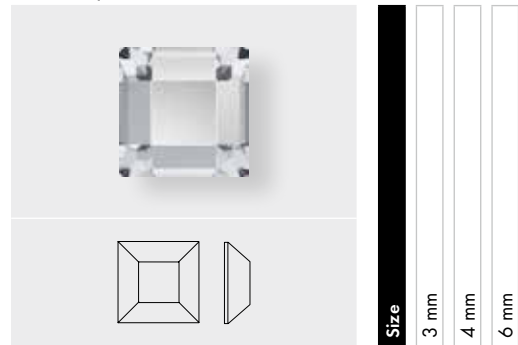

Size	3 mm	4 mm	6 mm
------	------	------	------

Crystal

Crystal F (001)

Flat Backs No Hotfix

2420 Asymmetric Square Flat Back ¹⁾

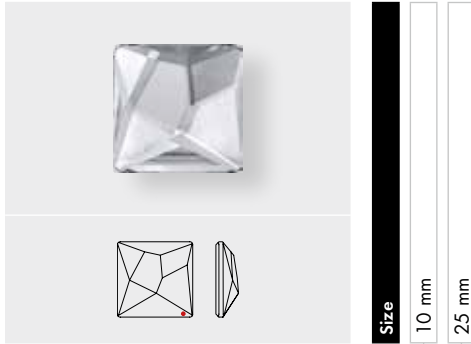

Size	
10 mm	25 mm

Crystal	
Crystal F (001)	
Crystal CAL V SI (001 CAL V SI)	
Crystal Effects	
Transparent Effects	
Crystal Bermuda Blue F (001 BBL)	

2483 Classic Square Flat Back

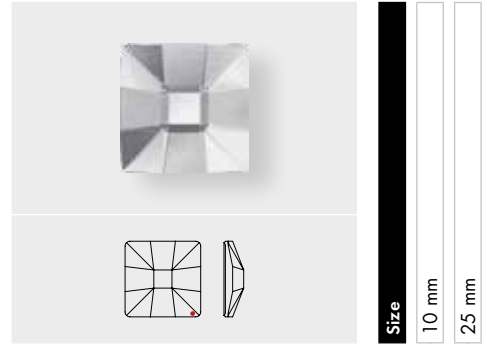

Size	
10 mm	25 mm

Crystal	
Crystal F (001)	
Crystal CAL SI (001 CAL SI) ¹⁾⁺²⁾	
Crystal CAL V SI (001 CAL V SI) ¹⁾	
Colors	
Plain Colors	
Jet (280)	

2493 Chessboard Flat Back

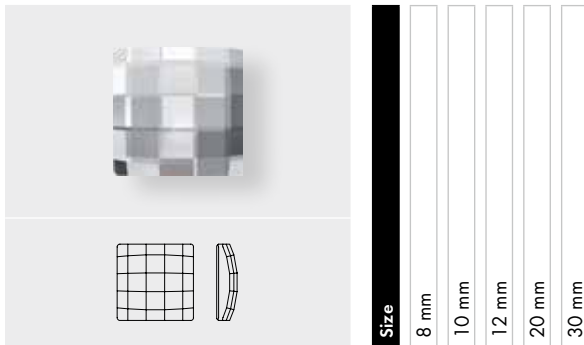

Size				
8 mm	10 mm	12 mm	20 mm	30 mm

Crystal				
Crystal F (001)				
Colors				
Plain Colors				
Black Diamond F (215)				
Jet F (280)				
Crystal Effects				
Transparent Effects				
Crystal AB F (001 AB)				
Crystal Golden Shadow F (001 GSHA)				
Crystal Patina				
Crystal Black Patina F (001 BLAPA)				
Crystal Gold Patina F (001 GOLPA)				
Crystal Rose Patina F (001 ROSPA)				
Crystal Silver Patina F (001 SILPA)				
Crystal White Patina F (001 WHIPA)				

2520 Cosmic Flat Back

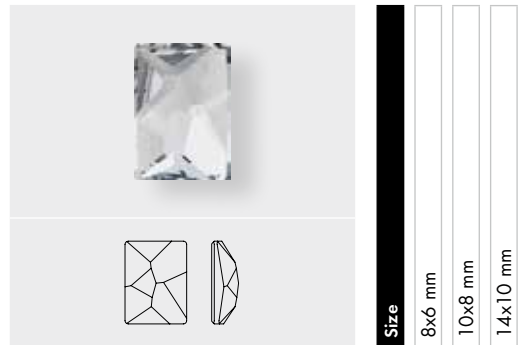

Size		
8x6 mm	10x8 mm	14x10 mm

Crystal		
Crystal F (001)		
Colors		
Plain Colors		
Jet (280)		
Crystal Effects		
Transparent Effects		
Crystal AB F (001 AB)		
Crystal Golden Shadow F (001 GSHA)		

¹⁾ Integrated articles of the former Bath & Wellness Collection may be partly delivered with a laser-engraved logo.

• The logo position is marked with a red dot.

²⁾ Coated on faceted side.

Flat Backs No Hotfix

2555 Cosmic Baguette Flat Back

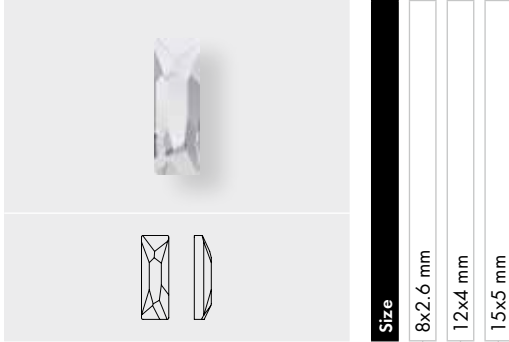

Size	8x2,6 mm	12x4 mm	15x5 mm
------	----------	---------	---------

- Crystal**
- Crystal F (001)
- Colors**
- Plain Colors**
- Jet (280)
- Crystal Effect**
- Transparent Effects**
- Crystal Golden Shadow F (001 GSHA)

2570 Vigour Rectangle Flat Back ¹⁾



Size	50x16 mm
------	----------

- Crystal**
- Crystal F (001)
- Crystal CAL SI (001 CAL SI) ¹⁾⁺²⁾
- Crystal CAL V SI (001 CAL V SI) ¹⁾

2585 Graphic Flat Back

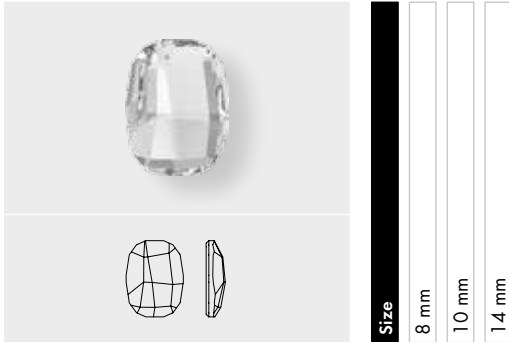

Size	8 mm	10 mm	14 mm
------	------	-------	-------

- Crystal**
- Crystal F (001)
- Colors**
- Plain Colors**
- Rose Peach F (262)
- Crystal Effects**
- Transparent Effects**
- Crystal AB F (001 AB)
- Crystal Luminous Green F (001 LUMG)

2611 Solaris Flat Back

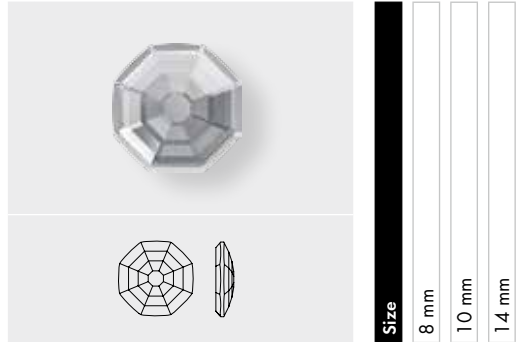

Size	8 mm	10 mm	14 mm
------	------	-------	-------

- Crystal**
- Crystal F (001)
- Colors**
- Plain Colors**
- Aquamarine F (202)
- Jet (280)
- Light Rose F (223)
- Crystal Effects**
- Transparent Effects**
- Crystal AB F (001 AB)
- Crystal Golden Shadow F (001 GSHA)
- Crystal Luminous Green F (001 LUMG)
- Crystal Silver Night F (001 SINI)
- Metallic Effects**
- Crystal Iridescent Green F (001 IRIG)

¹⁾ Integrated articles of the former Bath & Wellness Collection may be partly delivered with a laser-engraved logo.

• The logo position is marked with a red dot.

²⁾ Coated on faceted side.

Flat Backs No Hotfix

2611/G Solaris Flat Back partly frosted

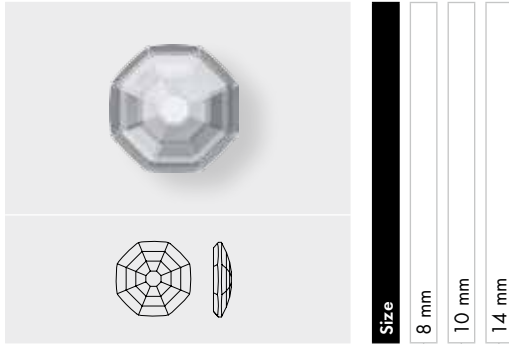

Size
8 mm
10 mm
14 mm

Crystal	8 mm	10 mm	14 mm
Crystal F (001)	■	■	■
Colors			
Plain Colors			
Aquamarine F (202)	■	■	■
Jet (280)	■	■	■
Light Rose F (223)	■	■	■
Crystal Effects			
Transparent Effects			
Crystal AB F (001 AB)	■	■	■
Crystal Golden Shadow F (001 GSHA)	■	■	■
Crystal Luminous Green F (001 LUMG)	■	■	■
Crystal Silver Night F (001 SINI)	■	■	■
Metallic Effects			
Crystal Iridescent Green F (001 IRIG)	■	■	■

2708 Molecule Flat Back

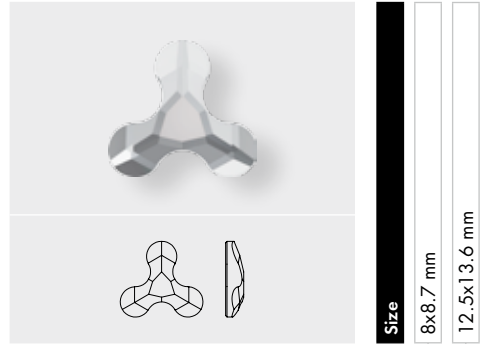

Size
8x8.7 mm
12.5x13.6 mm

Crystal	8x8.7 mm	12.5x13.6 mm
Crystal F (001)	■	■
Colors		
Plain Colors		
Amethyst F (204)	■	■
Blue Zircon F (229)	■	■
Dark Moss Green F (260)	■	■
Denim Blue F (266)	■	■
Fuchsia F (502)	■	■
Jet (280)	■	■
Light Silk F (261)	■	■
Light Turquoise F (263)	■	■
Crystal Effects		
Transparent Effects		
Crystal AB F (001 AB)	■	■
Crystal Antique Pink F (001 ANTP)	■	■
Crystal Blue Shade F (001 BLSH)	■	■
Crystal Golden Shadow F (001 GSHA)	■	■
Crystal Silver Night F (001 SINI)	■	■
Metallic Effects		
Crystal Iridescent Green F (001 IRIG)	■	■
Crystal Rose Gold F (001 ROGL)	■	■

Flat Backs No Hotfix

2709 Rhombus Flat Back

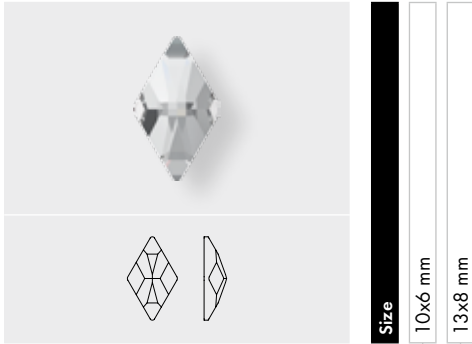

Size
10x6 mm
13x8 mm

- Crystal**
- Crystal F (001)
- Colors**
- Plain Colors**
- Aquamarine F (202)
- Black Diamond F (215)
- Light Rose F (223)
- Light Siam F (227)
- Crystal Effects**
- Transparent Effects**
- Crystal AB F (001 AB)
- Crystal Golden Shadow F (001 GSHA)
- Crystal Silver Shade F (001 SSHA)

2716 Rivoli Triangle Flat Back

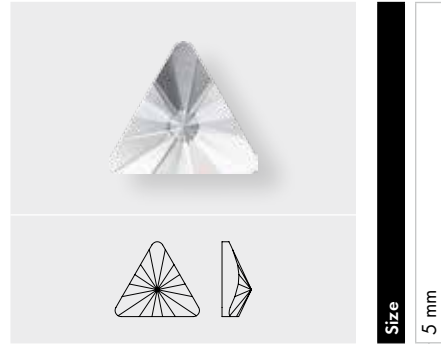

Size
5 mm

- Crystal**
- Crystal F (001)
- Crystal Effect**
- Transparent Effects**
- Crystal AB F (001 AB)

2720 Cosmic Delta Flat Back

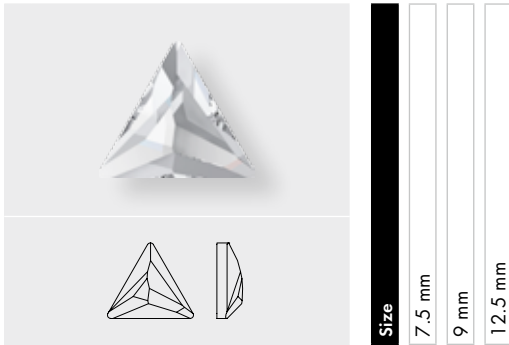

Size
7.5 mm
9 mm
12.5 mm

- Crystal**
- Crystal F (001)

2770 Wing Flat Back

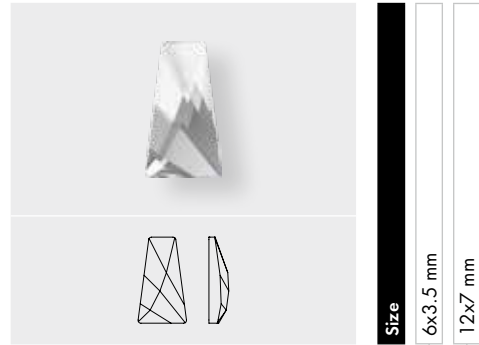

Size
6x3.5 mm
12x7 mm

- Crystal**
- Crystal F (001)
- Color**
- Plain Color**
- Black Diamond F (215)
- Crystal Effects**
- Transparent Effects**
- Crystal Golden Shadow F (001 GSHA)
- Crystal Silver Shade F (001 SSHA)

Flat Backs No Hotfix

2788 Wave Flat Back



Size	8 mm	10 mm	14 mm
Crystal			
Crystal F (001)	<input type="checkbox"/>	<input type="checkbox"/>	<input type="checkbox"/>

2797 Diamond Leaf Flat Back

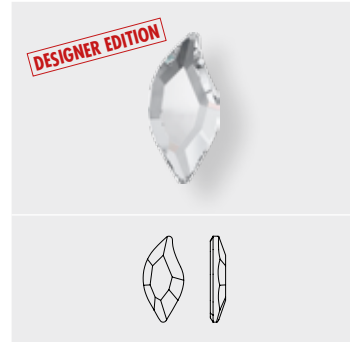

Size	8x4 mm	10x5 mm
Crystal		
Crystal F (001)	<input type="checkbox"/>	<input type="checkbox"/>
Crystal Effect		
Transparent Effects		
Crystal AB F (001 AB)	<input type="checkbox"/>	<input type="checkbox"/>

2808 Heart Flat Back

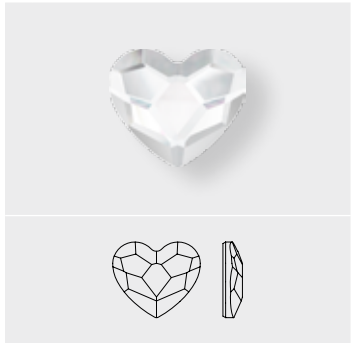

Size	6 mm	10 mm	14 mm
Crystal			
Crystal F (001)	<input type="checkbox"/>	<input type="checkbox"/>	<input type="checkbox"/>
Colors			
Plain Colors			
Dark Moss Green F (260)	<input type="checkbox"/>	<input type="checkbox"/>	<input type="checkbox"/>
Denim Blue F (266)	<input type="checkbox"/>	<input type="checkbox"/>	<input type="checkbox"/>
Fuchsia F (502)	<input type="checkbox"/>	<input type="checkbox"/>	<input type="checkbox"/>
Jet (280)	<input type="checkbox"/>	<input type="checkbox"/>	<input type="checkbox"/>
Light Siam F (227)	<input type="checkbox"/>	<input type="checkbox"/>	<input type="checkbox"/>
Light Silk F (261)	<input type="checkbox"/>	<input type="checkbox"/>	<input type="checkbox"/>
Rosaline F (508)	<input type="checkbox"/>	<input type="checkbox"/>	<input type="checkbox"/>
Crystal Effects			
Transparent Effects			
Crystal AB F (001 AB)	<input type="checkbox"/>	<input type="checkbox"/>	<input type="checkbox"/>
Crystal Antique Pink F (001 ANTP)	<input type="checkbox"/>	<input type="checkbox"/>	<input type="checkbox"/>
Crystal Astral Pink F (001 API)	<input type="checkbox"/>	<input type="checkbox"/>	<input type="checkbox"/>
Crystal Golden Shadow F (001 GSHA)	<input type="checkbox"/>	<input type="checkbox"/>	<input type="checkbox"/>
Metallic Effects			
Crystal Rose Gold F (001 ROGL)	<input type="checkbox"/>	<input type="checkbox"/>	<input type="checkbox"/>
Crystal Patina			
Crystal Black Patina F (001 BLAPA)	<input type="checkbox"/>	<input type="checkbox"/>	<input type="checkbox"/>
Crystal Gold Patina F (001 GOLPA)	<input type="checkbox"/>	<input type="checkbox"/>	<input type="checkbox"/>
Crystal Rose Patina F (001 ROSPA)	<input type="checkbox"/>	<input type="checkbox"/>	<input type="checkbox"/>
Crystal Silver Patina F (001 SILPA)	<input type="checkbox"/>	<input type="checkbox"/>	<input type="checkbox"/>
Crystal White Patina F (001 WHIPA)	<input type="checkbox"/>	<input type="checkbox"/>	<input type="checkbox"/>

Flat Backs No Hotfix

2816 Rivoli Star Flat Back

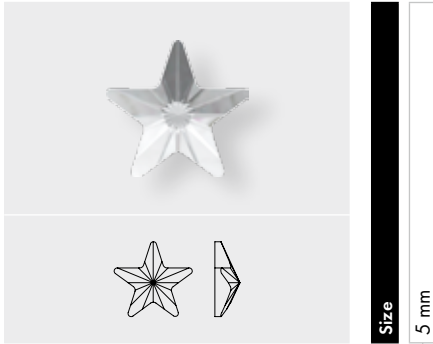

Size
5 mm

- Crystal**
- Crystal F (001)
- Crystal Effects**
- Transparent Effects**
- Crystal AB F (001 AB)

2826 Rivoli Snowflake Flat Back

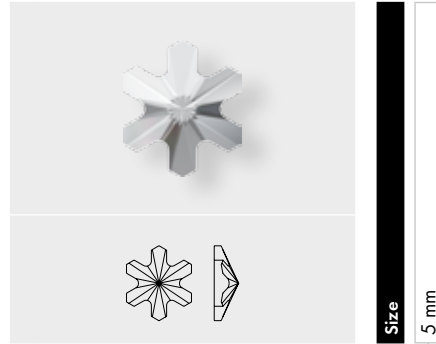

Size
5 mm

- Crystal**
- Crystal F (001)
- Crystal Effects**
- Transparent Effects**
- Crystal AB F (001 AB)

2854 Butterfly Flat Back

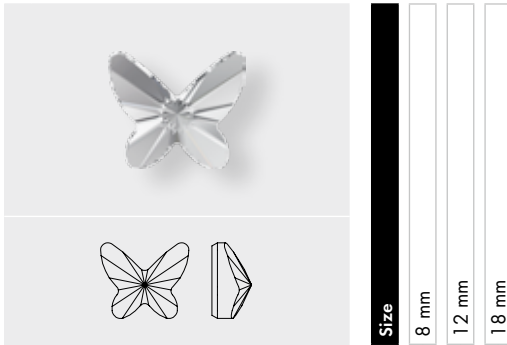

Size
8 mm
12 mm
18 mm

- Crystal**
- Crystal F (001)
- Colors**
- Plain Colors**
- Amethyst F (204)
- Denim Blue F (266)
- Light Rose F (223)
- Rose Peach F (262)
- Crystal Effects**
- Transparent Effects**
- Crystal AB F (001 AB)
- Crystal Antique Pink F (001 ANTP)
- Crystal Golden Shadow F (001 GSHA)
- Crystal Silver Night F (001 SINI)

2858 Bow Tie Flat Back

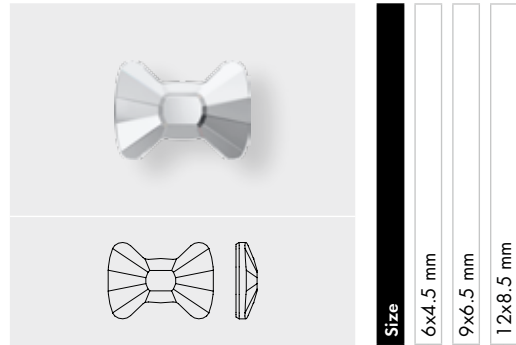

Size
6x4.5 mm
9x6.5 mm
12x8.5 mm

- Crystal**
- Crystal F (001)
- Colors**
- Plain Colors**
- Denim Blue F (266)
- Jet (280)
- Light Amethyst F (212)
- Light Siam F (227)
- Tangerine F (259)
- Vintage Rose F (319)
- Opal Colors**
- White Opal F (234)
- Crystal Effects**
- Transparent Effects**
- Crystal AB F (001 AB)
- Crystal Golden Shadow F (001 GSHA)
- Crystal Luminous Green F (001 LUMG)
- Crystal Silver Night F (001 SINI)
- Metallic Effects**
- Crystal Iridescent Green F (001 IRIG)

Flat Backs No Hotfix

PRODUCT DETAILS

Article Size	Packing Unit = Minimum Order Quantity in Pieces	Average Net Weight in Gram per Packing Unit Crystal (001)	Average Gross Weight in Gram per Packing Unit Crystal (001)
2000			
SS 3	1,440	1.8	12.7
SS 4	1,440	3.3	13.7
2006			
10 mm	288	89.9	116.4
12 mm	144	87.2	110.9
14 mm	144	132.4	158.7
16 mm	144	188.6	222.4
2035			
6 mm	360	27.1	34.8
10 mm	192	56.2	88.0
14 mm	96	88.4	109.0
20 mm	40	82.0	121.4
30 mm	12	95.4	130.8
40 mm	6	105.3	140.3
2037			
8 mm	240	14.48	23.58
14 mm	72	12.05	39.99
17 mm	72	27.72	52.20
2058			
SS 5	1,440	4.36	17.87
SS 6	1,440	5.66	17.62
SS 7	1,440	7.06	19.01
SS 8	1,440	10.11	19.63
SS 9	1,440	12.44	21.95
SS 10	1,440	15.79	25.30
2058/B			
SS 7	1,440	7.06	19.01
SS 9	1,440	10.11	19.63
SS 12	1,440	22.06	30.26
SS 16	1,440	39.89	49.83
SS 20	1,440	72.20	80.89
2072			
8 mm	288	92.9	119.6
10 mm	144	90.6	111.0
12 mm	72	82.0	100.1
2088			
SS 12	1,440	22.06	30.26
SS 14	1,440	30.09	38.30
SS 16	1,440	39.89	49.83
SS 20	1,440	72.20	80.89
SS 30	288	34.56	63.02
SS 34	144	25.92	48.59
SS 40	144	50.04	75.07
SS 48	96	76.13	101.33
2200			
8x4 mm	720	49.6	60.2
2204			
6x4.8 mm	360	27.237	36.368
10x8 mm	144	31.450	53.332
14x11 mm	108	52.618	74.012

Flat Backs No Hotfix

08 Flat Backs No Hotfix

Article Size	Packing Unit = Minimum Order Quantity in Pieces	Average Net Weight in Gram per Packing Unit Crystal (001)	Average Gross Weight in Gram per Packing Unit Crystal (001)
2300			
8x4.8 mm	720	83.9	94.5
10x6 mm	360	56.9	67.8
2400			
3 mm	1,440	25.3	36.8
4 mm	720	30.0	41.0
6 mm	144	21.6	32.5
2420			
10 mm	144	91.6	118.2
25 mm	32	200.8	251.8
2483			
10 mm	144	90.3	120.2
25 mm	32	233.3	261.5
2493			
8 mm	216	72.3	91.8
10 mm	144	84.4	106.1
12 mm	96	96.4	127.8
20 mm	24	108.5	137.9
30 mm	6	92.4	123.2
2520			
8x6 mm	288	50.8	80.2
10x8 mm	144	72.3	90.4
14x10 mm	144	119.3	140.8
2555			
8x2.6 mm	240	18.4	27.5
12x4 mm	144	28.8	33.6
15x5 mm	72	28.9	46.0
2570			
50x16 mm	6	52.9	81.6
2585			
8 mm	288	48.21	68.08
10 mm	288	72.32	104.28
14 mm	144	106.06	145.52
2611			
8 mm	144	29.400	38.548
10 mm	216	93.623	115.940
14 mm	48	42.336	63.504
2611/G			
8 mm	144	29.400	38.548
10 mm	216	93.623	115.940
14 mm	48	42.336	63.504
2708			
8x8.7 mm	288	28.063	57.335
12.5x13.6 mm	96	49.318	69.271
2709			
10x6 mm	288	48.2	73.6
13x8 mm	144	41.0	60.1
2716			
5 mm	720	35.78	75.11

Flat Backs No Hotfix

Article Size	Packing Unit = Minimum Order Quantity in Pieces	Average Net Weight in Gram per Packing Unit Crystal (001)	Average Gross Weight in Gram per Packing Unit Crystal (001)
2720			
7.5 mm	240	27.9	37.0
9 mm	180	45.1	54.2
12.5 mm	144	71.1	87.1
2770			
6x3.5 mm	1,440	60.3	70.3
12x7 mm	192	49.8	98.4
2788			
8 mm	288	7.54	18.43
10 mm	216	10.54	37.75
14 mm	144	16.99	45.07
2797			
8x4 mm	240	14.9	24.0
10x15 mm	180	23.4	32.6
2808			
6 mm	288	19.772	28.919
10 mm	144	38.823	55.902
14 mm	96	56.448	86.849
2816			
5 mm	720	23.56	30.69
2826			
5 mm	720	23.06	30.07
2854			
8 mm	216	35.98	52.18
12 mm	144	84.37	103.81
18 mm	72	120.53	144.22
2858			
6x4.5 mm	240	12.51	21.66
9x6.5 mm	144	23.39	44.05
12x8.5 mm	96	28.71	49.79