



## Flat Backs Hotfix

Flat Backs Hotfix are loose crystal elements with a flat reverse side that has been pre-coated with a heat-sensitive glue. These Flat Backs can be easily applied to a large range of textile carrier materials using heat to produce a durable and long-lasting crystal effect.

Flat Backs Hotfix are available in a multitude of colours, shapes and cuts. The increased light reflection and warmer appearance of the Flat Back Rose are achieved through a particular silver mirror on the reverse side.

The most innovative single item in this product group is art. 2078 XIRIUS Rose, with its most progressive and unique cut in the market: multilayer cut technology creates the inspiring XIRIUS star design. Superior fire and a rich, well balanced cloud of light points redefine the market standard.

Swarovski's outstanding quality standards of crystal elements are underlined by highest precision in table size and diameter.

COLORS & EFFECTS

## Colors



Crystal  
001



Chalkwhite  
279



White Opal  
234



Light Silk  
261



Silk  
391



Light Peach  
362



Rosaline  
508



Vintage Rose  
319



Light Rose  
223



Rose Peach  
262



Padparadscha  
542



Indian Pink  
289



Sun  
248



Fireopal\*  
237



Hyacinth  
236



Light Siam  
227



Indian Siam\*  
327



Rose  
209



Fuchsia  
502



Ruby  
501



Siam  
208



Burgundy  
515



Amethyst  
204



Purple Velvet  
277



Cobalt  
369



Tanzanite  
539



Light Amethyst  
212



Provence Lavender  
283



Light Sapphire  
211



Aquamarine  
202



Sapphire  
206



Capri Blue  
243



Dark Indigo  
288



Montana  
207



Caribbean Blue Opal  
394



Light Turquoise  
263



Blue Zircon  
229



Denim Blue  
266



Black Diamond  
215



Pacific Opal  
390



Chrysolite  
238



Peridot  
214



Erinite  
360



Fern Green  
291



Dark Moss Green  
260



Emerald  
205



Olivine  
228



Khaki  
550



Greige  
284



Light Grey Opal  
383



Light Colorado Topaz  
246



Jonquil  
213



Citrine  
249



Light Topaz  
226

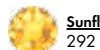

Sunflower  
292



Topaz  
203



Tangerine  
259

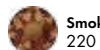

Smoked Topaz  
220



Mocca  
286



Jet  
280

## Ceramics



Marbled Light Grey  
657



Marbled Terracotta  
655



Marbled Yellow  
652



Marbled Blue  
654



Marbled Black  
653

## Effects



Crystal Hotfix Transparent\*  
001 HFT



Crystal Silver Shade  
001 SSHA

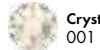

Crystal Moonlight  
001 MOL



Crystal Aurore Boreale  
001 AB



Crystal Luminous Green\*\*  
001 LUMG



Crystal Golden Shadow  
001 GSHA



Crystal Rose Gold  
001 ROGL



Crystal Copper\*\*  
001 COP



Crystal Astral Pink  
001 API



Light Siam Aurore Boreale  
227 AB



Light Siam Satin\*\*  
227 SAT



Crystal Red Magma  
001 REDM



Light Rose Aurore Boreale  
223 AB



Crystal Antique Pink  
001 ANTP



Crystal Transmission  
Hotfix Transparent  
001 TRA HFT



Crystal Volcano  
001 VOL



Crystal Lilac Shadow  
001 LISH

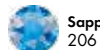

Sapphire Satin\*\*  
206 SAT



Crystal Metallic Blue\*\*  
001 METBL



Crystal Meridian Blue  
001 MBL



Crystal Blue Shade  
001 BLSH



Blue Zircon Satin\*\*  
229 SAT



Jonquil Aurore Boreale  
213 AB

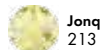

Jonquil Satin\*\*  
213 SAT

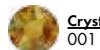

Crystal Tabac  
001 TAB



Crystal Iridescent Green  
001 IRIG

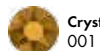

Crystal Dorado\*\*  
001 DOR



Crystal Metallic Light  
Gold\*\*  
001 MLGLD



Crystal Bronze Shade\*\*  
001 BRSH

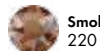

Smoked Topaz Satin\*\*  
220 SAT



Crystal Silver Night  
001 SINI



Jet Nut\*\*  
280 NUT

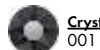

Crystal Cosmojet\*  
001 COS



Jet Hematite\*\*  
280 HEM



Jet Aurore Boreale  
280 AB

## Cabochons

### Colors



Crystal White Pearl HF  
001 650



Crystal Nacre HF  
001 191



Crystal Creampearl HF  
001 291



Crystal Golden Shadow HF  
001 GSHA



Crystal Bronze Pearl HF  
001 295



Crystal Rosaline Pearl HF  
001 294



Crystal Chrome V HF  
001 CHRMV



Crystal Light Grey Pearl HF  
001 616



Crystal Dark Grey Pearl HF  
001 617



Jet HF  
280



Jet Hematite HF  
280 HEM

### Gemcolors



Crystal Pink Coral Pearl HF  
001 716



Crystal Red Coral Pearl HF  
001 718



Crystal Turquoise Pearl HF  
001 709



Crystal Jade Pearl HF  
001 715

## Numerical Order

001	Crystal	001 MLGLD	<u>Crystal Metallic Light Gold**</u>	223 AB	Light Rose Aurore Boreale	280 NUT	Jet Nut**
001 191	Crystal Narce HF	001 MOL	Crystal Moonlight	226	Light Topaz	283	Provence Lavender
001 291	Crystal Creampearl HF	001 REDM	<u>Crystal Red Magma</u>	227	Light Siam	284	Greige
001 294	Crystal Rosaline Pearl HF	001 ROGL	<u>Crystal Rose Gold</u>	227 AB	Light Siam Aurore Boreale	286	Mocca
001 295	Crystal Bronze Pearl HF	001 SINI	<u>Crystal Silver Night</u>	227 SAT	Light Siam Satin**	288	<u>Dark Indigo</u>
001 616	Crystal Light Grey Pearl HF	001 SSHA	<u>Crystal Silver Shade</u>	228	Olivine	289	Indian Pink
001 617	Crystal Dark Grey Pearl HF	001 TAB	<u>Crystal Tabac</u>	229	Blue Zircon	291	<u>Fern Green</u>
001 650	Crystal White Pearl HF	001 TRA HFT	<u>Crystal Transmission Hofix Transparent</u>	229 SAT	Blue Zircon Satin**	292	<u>Sunflower</u>
001 709	Crystal Turquoise Pearl HF	001 VOL	Crystal Volcano	234	White Opal	319	<u>Vintage Rose</u>
001 715	Crystal Jade Pearl HF	202	Aquamarine	236	Hyacinth	327	<u>Indian Siam*</u>
001 716	Crystal Pink Coral Pearl HF	203	Topaz	237	<u>Fireopal*</u>	360	<u>Erinite</u>
001 718	Crystal Red Coral Pearl HF	204	Amethyst	238	Chrysolite	362	Light Peach
001 AB	Crystal Aurore Boreale	205	Emerald	243	Capri Blue	369	Cobalt
001 ANTP	<u>Crystal Antique Pink</u>	206	Sapphire	246	Light Colorado Topaz	383	<u>Light Grey Opal</u>
001 API	<u>Crystal Astral Pink</u>	206 SAT	Sapphire Satin**	248	Sun	390	<u>Pacific Opal</u>
001 BLSH	<u>Crystal Blue Shade</u>	207	Montana	249	Citrine	391	Silk
001 BRSH	<u>Crystal Bronze Shade**</u>	208	Siam	259	<u>Tangerine</u>	394	<u>Caribbean Blue Opal</u>
001 CHRMV	Crystal Chrome V HF	209	Rose	260	<u>Dark Moss Green</u>	501	Ruby
001 COP	<u>Crystal Copper**</u>	211	Light Sapphire	261	Light Silk	502	Fuchsia
001 COS	<u>Crystal Cosmojet*</u>	212	Light Amethyst	262	<u>Rose Peach</u>	508	Rosaline
001 DOR	Crystal Dorado**	213	Jonquil	263	Light Turquoise	515	Burgundy
001 GSHA	<u>Crystal Golden Shadow</u>	213 AB	Jonquil Aurore Boreale	266	Denim Blue	539	Tanzanite
001 GSHA	<u>Crystal Golden Shadow HF</u>	213 SAT	Jonquil Satin**	277	Purple Velvet	542	<u>Padparadscha</u>
001 HFT	<u>Crystal Hofix Transparent*</u>	214	Peridot	279	Chalkwhite	550	<u>Khaki</u>
001 IRIG	<u>Crystal Iridescent Green</u>	215	Black Diamond	280	Jet	652	<u>Marbled Yellow</u>
001 LISH	<u>Crystal Lilac Shadow</u>	220	Smoked Topaz	280	Jet HF	653	<u>Marbled Black</u>
001 LUMG	<u>Crystal Luminous Green**</u>	220 SAT	Smoked Topaz Satin**	280 AB	Jet Aurore Boreale	654	<u>Marbled Blue</u>
001 MBL	<u>Crystal Meridian Blue</u>	223	Light Rose	280 HEM	Jet Hematite**	655	<u>Marbled Terracotta</u>
001 METBL	Crystal Metallic Blue**			280 HEM	Jet Hematite HF	657	<u>Marbled Light Grey</u>

## Alphabetical Order

Amethyst (204)	Crystal Jade Pearl HF (001 715)	Fuchsia (502)	<u>Marbled Blue (654)</u>
Aquamarine (202)	Crystal Light Grey Pearl HF (001 616)	<u>Greige (284)</u>	<u>Marbled Light Grey (657)</u>
Black Diamond (215)	<u>Crystal Lilac Shadow (001 LISH)</u>	Hyacinth (236)	<u>Marbled Terracotta (655)</u>
Blue Zircon (229)	<u>Crystal Luminous Green (001 LUMG)**</u>	Indian Pink (289)	<u>Marbled Yellow (652)</u>
Blue Zircon Satin (229 SAT)**	<u>Crystal Meridian Blue (001 MBL)</u>	Indian Siam (327)*	Mocca (286)
Burgundy (515)	Crystal Metallic Blue (001 METBL)**	Jet (280)	Montana (207)
Capri Blue (243)	<u>Crystal Metallic Light Gold (001 MLGLD)**</u>	Jet Aurore Boreale (280 AB)	Olivine (228)
Caribbean Blue Opal (394)	Crystal Moonlight (001 MOL)	Jet Hematite (280 HEM)**	<u>Pacific Opal (390)</u>
Chalkwhite (279)	Crystal Narce HF (001 191)	Jet Hematite HF (280 HEM)	<u>Padparadscha (542)</u>
Chrysolite (238)	Crystal Pink Coral Pearl HF (001 716)	Jet HF (280)	Peridot (214)
Citrine (249)	Crystal Red Coral Pearl HF (001 718)	Jet Nut (280 NUT)**	Provence Lavender (283)
Cobalt (369)	<u>Crystal Red Magma (001 REDM)</u>	Jonquil (213)	Purple Velvet (277)
Crystal (001)	Crystal Rosaline Pearl HF (001 294)	Jonquil Aurore Boreale (213 AB)	Rosaline (508)
<u>Crystal Antique Pink (001 ANTP)</u>	Crystal Rose Gold (001 ROGL)	Jonquil Satin (213 SAT)**	Rose (209)
<u>Crystal Astral Pink (001 API)</u>	<u>Crystal Silver Night (001 SINI)</u>	Khaki (550)	<u>Rose Peach (262)</u>
Crystal Aurore Boreale (001 AB)	<u>Crystal Silver Shade (001 SSHA)</u>	Light Amethyst (212)	Ruby (501)
<u>Crystal Blue Shade (001 BLSH)</u>	<u>Crystal Tabac (001 TAB)</u>	Light Colorado Topaz (246)	Sapphire (206)
Crystal Bronze Pearl HF (001 295)	<u>Crystal Transmission Hofix Transparent (001 TRA HFT)</u>	<u>Light Grey Opal (383)</u>	Sapphire Satin (206 SAT)**
<u>Crystal Bronze Shade (001 BRSH)**</u>	Crystal Turquoise Pearl HF (001 709)	Light Peach (362)	Siam (208)
Crystal Chrome V HF (001 CHRMV)	Crystal Volcano (001 VOL)	Light Rose (223)	Silk (391)
<u>Crystal Copper (001 COP)**</u>	Crystal White Pearl HF (001 650)	Light Rose Aurore Boreale (223 AB)	Smoked Topaz (220)
<u>Crystal Cosmojet (001 COS)*</u>	<u>Dark Indigo (288)</u>	Light Sapphire (211)	Smoked Topaz Satin (220 SAT)**
Crystal Creampearl HF (001 291)	<u>Denim Blue (266)</u>	Light Siam (227)	<u>Sunflower (292)</u>
Crystal Dark Grey Pearl HF (001 617)	Emerald (205)	Light Siam Aurore Boreale (227 AB)	<u>Tangerine (259)</u>
Crystal Dorado (001 DOR)**	Erinite (360)	Light Siam Satin (227 SAT)**	Tanzanite (539)
<u>Crystal Golden Shadow (001 GSHA)</u>	<u>Fern Green (291)</u>	<u>Light Silk (261)</u>	Topaz (203)
<u>Crystal Golden Shadow HF (001 GSHA)</u>	<u>Fireopal (237)*</u>	Light Topaz (226)	<u>Vintage Rose (319)</u>
<u>Crystal Hofix Transparent (001 HFT)*</u>		Light Turquoise (263)	White Opal (234)
<u>Crystal Iridescent Green (001 IRIG)</u>		<u>Marbled Black (653)</u>	

This color chart is valid for the product groups Flat Backs Hofix and Sew-on Stones.

The displayed assortment is not entirely available for all products within the product groups. For details on available colors and effects, please see the product matrix for the respective item.

**Classic Colors:** This color range offers a wide choice of traditional Swarovski crystal colors.

**Exclusive Colors:** This color range is offered exclusively by Swarovski.

The standard assortment of colors and effects may vary according to the product group.

Slight changes in shades are unavoidable. Colors may vary according to cut and shape.

\* Only available in limited sizes.

\*\* Crystals are not resistant to plating and similar processing.



# Flat Backs Hotfix

## SUMMARY

1	2		1	2		1	2	
		<b>2000 A HF</b> SS 3			<b>2520 M HF</b> 8x6, 10x8, 14x10 mm			<b>2797 M HF</b> 8x4 mm
		<b>2035 M HF</b> 6, 10, 14, 20 mm			<b>2555 M HF</b> 8x2.6, 12x4, 15x5 mm			<b>2808 M HF</b> 6, 10, 14 mm
		<b>2037 M HF</b> 8, 14, 17 mm			<b>2585 M HF</b> 8, 10, 14 mm			<b>2816 M HF</b> 5 mm
		<b>2038 A HF</b> SS 5, 6, 8, 10			<b>2610 M HF</b> 6x4 mm			<b>2817 M HF</b> 5 mm
		<b>2038/B HF</b> SS 8, 10, 12, 16, 20			<b>2611 M HF</b> 8, 10, 14 mm			<b>2826 M HF</b> 5 mm
		<b>2078 A HF</b> SS 12, 16, 20, 30, 34, 40, 48			<b>2611/G M HF</b> 8, 10, 14 mm			<b>2855 M HF</b> 8 mm
		<b>2080/4 HF</b> SS 10, 16, 34			<b>2708 M HF</b> 8x8.7, 12.5x13.6 mm			<b>2855/G M HF</b> 8 mm
		<b>2200 M HF</b> 8x4 mm			<b>2709 M HF</b> 10x6 mm			<b>2858 M HF</b> 6x4.5, 9x6.5, 12x8.5 mm
		<b>2204 M HF</b> 6x4.8, 10x8, 14x11 mm			<b>2711 M HF</b> 6 mm			
		<b>2300 M HF</b> 8x4.8 mm			<b>2716 M HF</b> 5 mm			
		<b>2400 M HF</b> 3, 4 mm			<b>2720 M HF</b> 7.5, 9, 12.5 mm			
		<b>2483 M HF</b> 10 mm			<b>2728 M HF</b> SS 10, 16, 20, 34			
		<b>2493 M HF</b> 8, 10, 12, 20 mm			<b>2770 M HF</b> 6x3.5, 12x7, 16x9.5 mm			
		<b>2510 M HF</b> 5x2.5 mm			<b>2788 M HF</b> 8, 10, 14 mm			

# Flat Backs Hotfix

## 2000 Rose

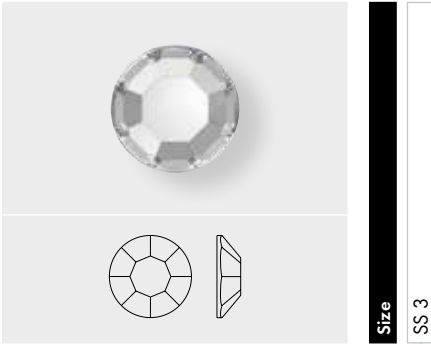

Size  
SS 3

- Crystal**
- Crystal A HF (001)
- Colors**
- Plain Colors**
- Amethyst A HF (204)
- Aquamarine A HF (202)
- Black Diamond A HF (215)
- Jet A HF (280)
- Light Colorado Topaz A HF (246)
- Light Rose A HF (223)
- Montana A HF (207)
- Peridot A HF (214)
- Smoked Topaz A HF (220)
- Crystal Effect**
- Transparent Effects**
- Crystal AB A HF (001 AB)
- Crystal Golden Shadow HF (001 GSHA)
- Crystal Silver Shade HF (001 SSHA)
- Metallic Effects**
- Crystal Metallic Blue HF (001 METBL)
- Crystal Metallic Light Gold HF (001 MLGLD)
- Crystal Rose Gold HF (001 ROGL)
- Crystal Effect**
- Metallic Effects**
- Jet Hematite (280 HEM)

## 2035 Chessboard Circle Flat Back

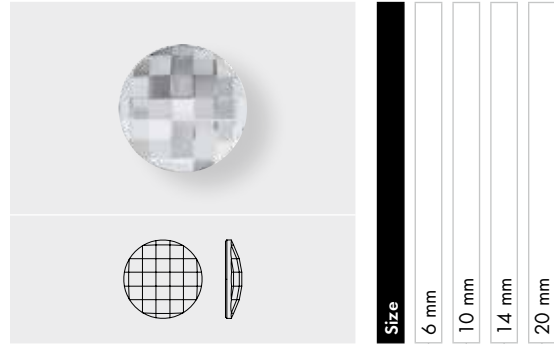

Size  
6 mm  
10 mm  
14 mm  
20 mm

- Crystal**
- Crystal M HF (001)
- Colors**
- Plain Colors**
- Jet M HF (280)
- Crystal Effects**
- Transparent Effects**
- Crystal AB M HF (001 AB)
- Crystal Golden Shadow M HF (001 GSHA)
- Crystal Red Magma M HF (001 REDM)

## 2037 Eclipse Flat Back

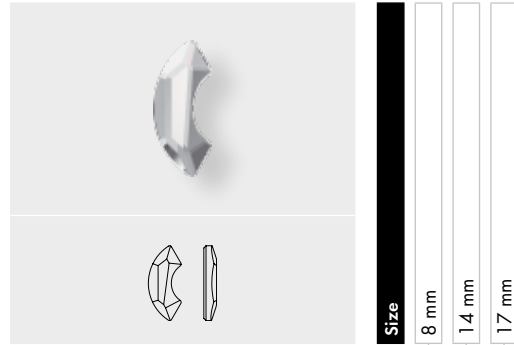

Size  
8 mm  
14 mm  
17 mm

- Crystal**
- Crystal M HF (001)
- Crystal Effect**
- Transparent Effects**
- Crystal Golden Shadow M HF (001 GSHA)



# Flat Backs Hotfix

## 2038 XILION Rose Hotfix

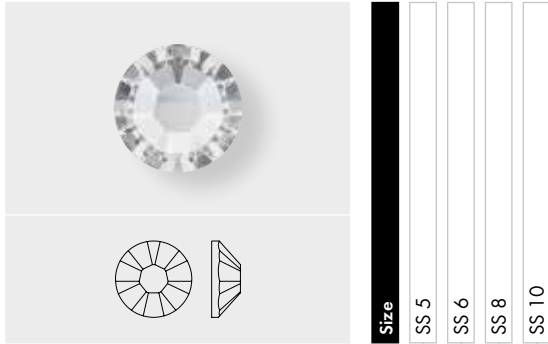

	Size	SS 5	SS 6	SS 8	SS 10
<b>Crystal</b>					
Crystal A HF (001)		■	■	■	■
Crystal Hotfix Transparent (001 HFT)			■	■	■
<b>Colors</b>					
<b>Plain Colors</b>					
Amethyst A HF (204)			■	■	■
Aquamarine A HF (202)			■	■	■
Black Diamond A HF (215)		■	■	■	■
Blue Zircon A HF (229)		■	■	■	■
Burgundy A HF (515)			■	■	■
Capri Blue A HF (243)		■	■	■	■
Chalkwhite A HF (279)			■	■	■
Chrysolite A HF (238)			■	■	■
Citrine A HF (249)			■	■	■
Cobalt A HF (369)			■	■	■
Dark Indigo A HF (288)			■	■	■
Dark Moss Green A HF (260)			■	■	■
Denim Blue A HF (266)			■	■	■
Emerald A HF (205)			■	■	■
Erinte A HF (360)			■	■	■
Fern Green A HF (291)			■	■	■
Fireopal A HF (237)					■
Fuchsia A HF (502)			■	■	■
Greige A HF (284)			■	■	■
Hyacinth A HF (236)			■	■	■
Indian Pink A HF (289)			■	■	■
Indian Siam A HF (327)			■	■	■
Jet A HF (280)		■	■	■	■
Jonquil A HF (213)			■	■	■
Khaki A HF (550)			■	■	■
Light Amethyst A HF (212)			■	■	■
Light Colorado Topaz A HF (246)		■	■	■	■
Light Peach A HF (362)			■	■	■
Light Rose A HF (223)		■	■	■	■
Light Sapphire A HF (211)			■	■	■
Light Siam A HF (227)		■	■	■	■
Light Silk A HF (261)			■	■	■
Light Topaz A HF (226)			■	■	■
Light Turquoise A HF (263)			■	■	■
Mocca A HF (286)			■	■	■
Montana A HF (207)			■	■	■

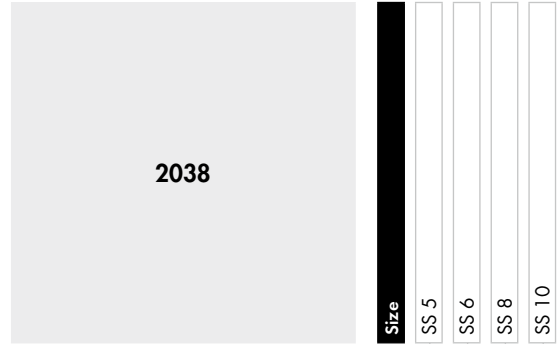

	Size	SS 5	SS 6	SS 8	SS 10
Olivine A HF (228)			■	■	■
Padparadscha A HF (542)			■	■	■
Peridot A HF (214)			■	■	■
Provence Lavender A HF (283)			■	■	■
Purple Velvet A HF (277)			■	■	■
Rose A HF (209)		■	■	■	■
Rose Peach A HF (262)			■	■	■
Ruby A HF (501)			■	■	■
Sapphire A HF (206)			■	■	■
Siam A HF (208)			■	■	■
Silk A HF (391)			■	■	■
Smoked Topaz A HF (220)			■	■	■
Sun A HF (248)			■	■	■
Sunflower A HF (292)			■	■	■
Tangerine A HF (259)			■	■	■
Tanzanite A HF (539)			■	■	■
Topaz A HF (203)			■	■	■
Vintage Rose A HF (319)			■	■	■
<b>Opal Colors</b>					
Caribbean Blue Opal A HF (394)			■	■	■
Light Grey Opal A HF (383)			■	■	■
Pacific Opal A HF (390)			■	■	■
White Opal A HF (234)			■	■	■
<b>Crystal Effects</b>					
<b>Transparent Effects</b>					
Crystal AB A HF (001 AB)			■	■	■
Crystal Antique Pink A HF (001 ANTP)			■	■	■
Crystal Blue Shade A HF (001 BLSH)			■	■	■
Crystal Bronze Shade A HF (001 BRSH)			■	■	■
Crystal Copper A HF (001 COP)			■	■	■
Crystal Cosmojet A HF (001 COS)			■	■	■
Crystal Golden Shadow A HF (001 GSHA)			■	■	■
Crystal Lilac Shadow A HF (001 LISH)			■	■	■
Crystal Luminous Green A HF (001 LUMG)			■	■	■
Crystal Meridian Blue A HF (001 MBL)			■	■	■
Crystal Moonlight A HF (001 MOL)			■	■	■
Crystal Silver Night A HF (001 SINI)			■	■	■
Crystal Silver Shade A HF (001 SSHA)			■	■	■
Crystal Tabac A HF (001 TAB)			■	■	■
Crystal Transmission HFT (001 TRA HFT)			■	■	■
Crystal Volcano A HF (001 VOL)			■	■	■

# Flat Backs Hotfix

2038		Size	SS 5	SS 6	SS 8	SS 10
<b>Metallic Effects</b>						
	Crystal Dorado A HF (001 DOR)			■	■	■
	Crystal Iridescent Green A HF (001 IRIG)			■	■	■
	Crystal Metallic Blue A HF (001 METBL)			■	■	■
	Crystal Metallic Light Gold A HF (001 MLGLD)			■	■	■
	Crystal Rose Gold A HF (001 ROGL)			■	■	■
<b>Color Effects</b>						
<b>Transparent Effects</b>						
	Blue Zircon Satin A HF (229 SAT)			■	■	■
	Jet AB A HF (280 AB)			■	■	■
	Jonquil AB A HF (213 AB)			■	■	■
	Jonquil Satin A HF (213 SAT)			■	■	■
	Light Rose AB A HF (223 AB)			■	■	■
	Light Siam AB A HF (227 AB)			■	■	■
	Light Siam Satin A HF (227 SAT)			■	■	■
	Sapphire Satin A HF (206 SAT)			■	■	■
	Smoked Topaz Satin A HF (220 SAT)			■	■	■
<b>Metallic Effects</b>						
	Jet Hematite A HF (280 HEM)		■	■	■	■
	Jet Nut A HF (280 NUT)			■	■	■

## 2038/B XILION Rose Flat Back

2038/B XILION Rose Flat Back		Size	SS 8	SS 10	SS 12	SS 16	SS 20
<b>Ceramics</b>							
	Marbled Black HFT (653)		■	■	■	■	■
	Marbled Blue HFT (654)		■	■	■	■	■
	Marbled Light Grey HFT (657)		■	■	■	■	■
	Marbled Terracotta HFT (655)		■	■	■	■	■
	Marbled Yellow HFT (652)		■	■	■	■	■

# Flat Backs Hotfix

## 2078 XIRIUS Rose Hotfix

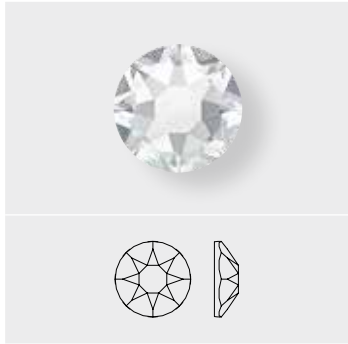

	SS 12	SS 16	SS 20	SS 30	SS 34	SS 40	SS 48
<b>Crystal</b>							
Crystal A HF (001)	■	■	■	■	■	■	■
Crystal Hotfix Transparent (001 HFT)		■					
<b>Colors</b>							
<b>Plain Colors</b>							
Amethyst A HF (204)	■	■	■	■	■		
Aquamarine A HF (202)	■	■	■	■	■		
Black Diamond A HF (215)	■	■	■	■	■		
Blue Zircon A HF (229)	■	■	■	■	■		
Burgundy A HF (515)	■	■	■	■	■		
Capri Blue A HF (243)	■	■	■	■	■		
Chalkwhite A HF (279)	■	■	■	■	■		
Chrysolite A HF (238)	■	■	■	■	■		
Citrine A HF (249)	■	■	■	■	■		
Cobalt A HF (369)	■	■	■	■	■		
Dark Indigo A HF (288)	■	■	■	■	■		
Dark Moss Green A HF (260)	■	■	■	■	■		
Denim Blue A HF (266)	■	■	■	■	■		
Emerald A HF (205)	■	■	■	■	■		
Erinte A HF (360)	■	■	■	■	■		
Fern Green A HF (291)	■	■	■	■	■		
Fireopal A HF (237)	■	■	■	■	■		
Fuchsia A HF (502)	■	■	■	■	■		
Greige A HF (284)	■	■	■	■	■		
Hyacinth A HF (236)	■	■	■	■	■		
Indian Pink A HF (289)	■	■	■	■	■		
Indian Siam A HF (327)	■	■	■	■	■		
Jet A HF (280)	■	■	■	■	■		
Jonquil A HF (213)	■	■	■	■	■		
Khaki A HF (550)	■	■	■	■	■		
Light Amethyst A HF (212)	■	■	■	■	■		
Light Colorado Topaz A HF (246)	■	■	■	■	■		
Light Peach A HF (362)	■	■	■	■	■		
Light Rose A HF (223)	■	■	■	■	■		
Light Sapphire A HF (211)	■	■	■	■	■		
Light Siam A HF (227)	■	■	■	■	■		
Light Silk A HF (261)	■	■	■	■	■		
Light Topaz A HF (226)	■	■	■	■	■		
Light Turquoise A HF (263)	■	■	■	■	■		
Mocca A HF (286)	■	■	■	■	■		
Montana A HF (207)	■	■	■	■	■		

# Flat Backs Hotfix

## 09 Flat Backs Hotfix

2078		Size	SS 12	SS 16	SS 20	SS 30	SS 34	SS 40	SS 48
	Olivine A HF (228)		■	■	■		■		
	Padparadscha A HF (542)		■	■	■		■		
	Peridot A HF (214)		■	■	■	■	■		
	Provence Lavender A HF (283)		■	■	■		■		
	Purple Velvet A HF (277)		■	■	■		■		
	Rose A HF (209)		■	■	■	■	■		
	Rose Peach A HF (262)		■	■	■		■		
	Ruby A HF (501)		■	■	■		■		
	Sapphire A HF (206)		■	■	■	■	■		
	Siam A HF (208)		■	■	■	■	■		
	Silk A HF (391)		■	■	■		■		
	Smoked Topaz A HF (220)		■	■	■	■	■		
	Sun A HF (248)		■	■	■		■		
	Sunflower A HF (292)		■	■	■		■		
	Tangerine A HF (259)		■	■	■		■		
	Tanzanite A HF (539)		■	■	■		■		
	Topaz A HF (203)		■	■	■	■	■		
	Vintage Rose A HF (319)		■	■	■		■		
<b>Opal Colors</b>									
	Caribbean Blue Opal A HF (394)		■	■	■		■		
	Light Grey Opal A HF (383)		■	■	■		■		
	Pacific Opal A HF (390)		■	■	■		■		
	White Opal A HF (234)		■	■	■		■		
<b>Crystal Effects</b>									
<b>Transparent Effects</b>									
	Crystal AB A HF (001 AB)		■	■	■	■	■	■	■
	Crystal Antique Pink A HF (001 ANTP)		■	■	■		■		
	Crystal Blue Shade A HF (001 BLSH)		■	■	■		■		
	Crystal Bronze Shade A HF (001 BRSH)		■	■	■		■		
	Crystal Copper A HF (001 COP)		■	■	■		■		
	Crystal Cosmojet A HF (001 COS)		■	■					
	Crystal Golden Shadow A HF (001 GSHA)		■	■	■	■	■		
	Crystal Lilac Shadow A HF (001 LISH)		■	■	■		■		
	Crystal Luminous Green A HF (001 LUMG)		■	■	■		■		
	Crystal Meridian Blue A HF (001 MBL)		■	■	■		■		
	Crystal Moonlight A HF (001 MOL)		■	■	■		■		
	Crystal Silver Night A HF (001 SINI)		■	■	■		■		
	Crystal Silver Shade A HF (001 SSHA)		■	■	■		■		
	Crystal Tabac A HF (001 TAB)		■	■	■		■		
	Crystal Transmission HFT (001 TRA HFT)		■	■	■		■		
	Crystal Volcano A HF (001 VOL)		■	■	■		■		

# Flat Backs Hotfix

2078		Size	SS 12	SS 16	SS 20	SS 30	SS 34	SS 40	SS 48
<b>Metallic Effects</b>									
	Crystal Dorado A HF (001 DOR)		■	■	■		■		
	Crystal Iridescent Green A HF (001 IRIG)		■	■	■		■		
	Crystal Metallic Blue A HF (001 METBL)		■	■	■		■		
	Crystal Metallic Light Gold A HF (001 MLGD)		■	■	■		■		
	Crystal Rose Gold A HF (001 ROGL)		■	■	■		■		
<b>Color Effects</b>									
<b>Transparent Effects</b>									
	Blue Zircon Satin A HF (229 SAT)		■	■	■		■		
	Jet AB A HF (280 AB)		■	■	■		■		
	Jonquil AB A HF (213 AB)		■	■	■		■		
	Jonquil Satin A HF (213 SAT)		■	■	■		■		
	Light Rose AB A HF (223 AB)		■	■	■		■		
	Light Siam AB A HF (227 AB)		■	■	■		■		
	Light Siam Satin A HF (227 SAT)		■	■	■		■		
	Sapphire Satin A HF (206 SAT)		■	■	■		■		
	Smoked Topaz Satin A HF (220 SAT)		■	■	■		■		
<b>Metallic Effects</b>									
	Jet Hematite A HF (280 HEM)		■	■	■	■	■		
	Jet Nut A HF (280 NUT)		■	■	■		■		

# Flat Backs Hotfix

## 2080/4 Cabochon

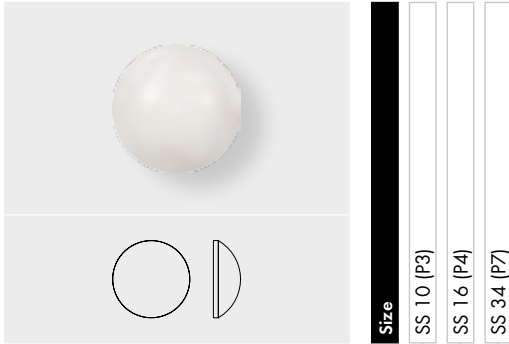

Size  
SS 10 (P3)  
SS 16 (P4)  
SS 34 (P7)

Colors	SS 10 (P3)	SS 16 (P4)	SS 34 (P7)
<b>Plain Colors</b>			
● Jet HF (280)	■	■	■
<b>Crystal Pearl Colors</b>			
● Crystal Bronze Pearl HF (001 295)	■	■	■
● Crystal Creampearl HF (001 291)	■	■	■
● Crystal Dark Grey Pearl HF (001 617)	■	■	■
● Crystal Light Grey Pearl HF (001 616)	■	■	■
● Crystal Rosaline Pearl HF (001 294)	■	■	■
● Crystal White Pearl HF (001 650)	■	■	■
<b>Gemcolors</b>			
● Crystal Jade Pearl HF (001 715)	■	■	■
● Crystal Pink Coral Pearl HF (001 716)	■	■	■
● Crystal Red Coral Pearl HF (001 718)	■	■	■
● Crystal Turquoise Pearl HF (001 709)	■	■	■
<b>Crystal Effects</b>			
<b>Transparent Effects</b>			
● Crystal Golden Shadow HF (001 GSHA)	■	■	■
● Crystal Nacre HF (001 191)	■	■	■
<b>Metallic Effects</b>			
● Crystal Chrom V HF (001 CHRMV)	■	■	■
<b>Color Effects</b>			
<b>Metallic Effects</b>			
● Jet Hematite HF (280 HEM)	■	■	■

## 2200 Navette Flat Back

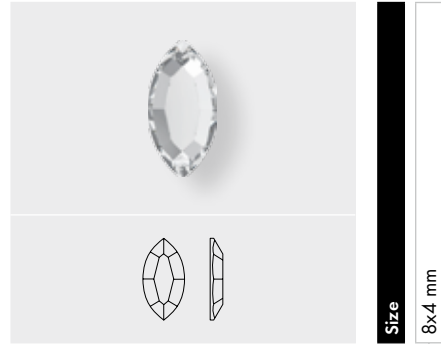

Size  
8x4 mm

Crystal	Size
● Crystal M HF (001)	■
<b>Colors</b>	
<b>Plain Colors</b>	
● Jet M HF (280)	■
<b>Crystal Effects</b>	
<b>Transparent Effects</b>	
● Crystal AB M HF (001 AB)	■
● Crystal Golden Shadow M HF (001 GSHA)	■
● Crystal Silver Shade M HF (001 SSHA)	■
<b>Color Effects</b>	
<b>Metallic Effects</b>	
● Jet Hematite M HF (280 HEM)	■

# Flat Backs Hotfix

## 2204 Pure Leaf Flat Back

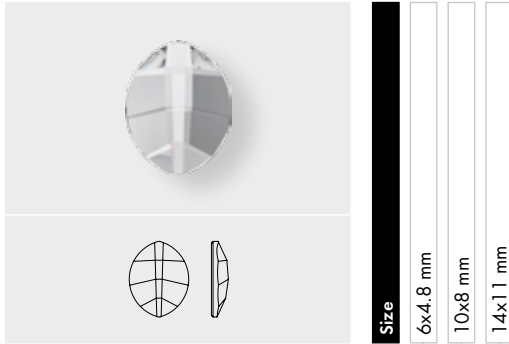

Crystal	6x4.8 mm	10x8 mm	14x11 mm
Crystal M HF (001)	■	■	■
<b>Colors</b>			
<b>Plain Colors</b>			
Amethyst M HF (204)	■	■	■
Dark Moss Green M HF (260)	■	■	■
Emerald M HF (205)	■	■	■
Jet M HF (280)	■	■	■
Light Siam M HF (227)	■	■	■
Peridot M HF (214)	■	■	■
<b>Crystal Effects</b>			
<b>Transparent Effects</b>			
Crystal AB M HF (001 AB)	■	■	■
Crystal Blue Shade M HF (001 BLSH)	■	■	■
Crystal Golden Shadow M HF (001 GSHA)	■	■	■
Crystal Luminous Green M HF (001 LUMG)	■	■	■
Crystal Silver Night M HF (001 SINI)	■	■	■

## 2300 Drop Flat Back

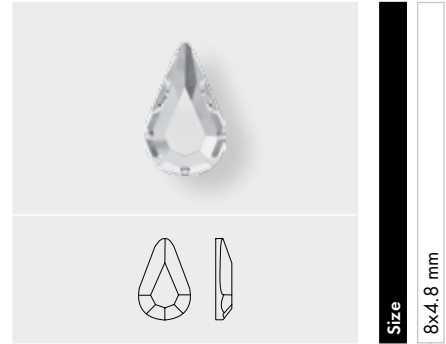

Crystal	8x4.8 mm
Crystal M HF (001)	■
<b>Colors</b>	
<b>Plain Colors</b>	
Jet M HF (280)	■
<b>Crystal Effects</b>	
<b>Transparent Effects</b>	
Crystal AB M HF (001 AB)	■
Crystal Golden Shadow M HF (001 GSHA)	■
<b>Color Effects</b>	
<b>Metallic Effects</b>	
Jet Hematite M HF (280 HEM)	■

# Flat Backs Hotfix

## 2400 Square Flat Back

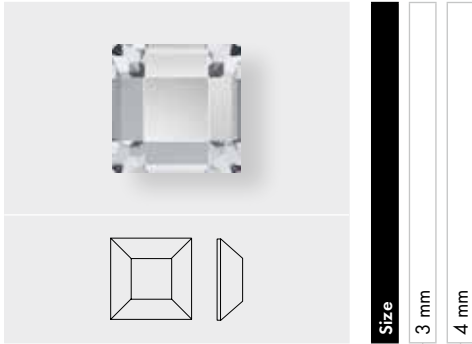

Size  
3 mm  
4 mm

- Crystal**
- Crystal M HF (001)
- Colors**
- Plain Colors**
- Jet M HF (280)
- Crystal Effects**
- Transparent Effects**
- Crystal AB M HF (001 AB)
- Crystal Golden Shadow M HF (001 GSHA)
- Color Effects**
- Metallic Effects**
- Jet Hematite M HF (280 HEM)

## 2483 Classic Square Flat Back

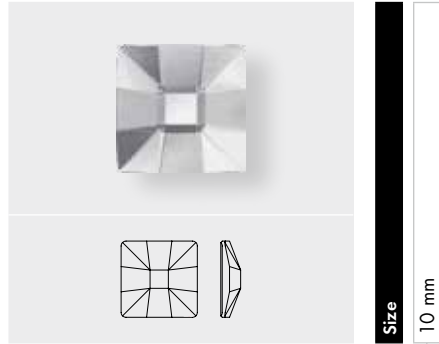

Size  
10 mm

- Crystal**
- Crystal M HF (001)
- Colors**
- Plain Colors**
- Black Diamond M HF (215)
- Crystal Effect**
- Transparent Effects**
- Crystal Golden Shadow M HF (001 GSHA)

## 2493 Chessboard Flat Back



Size  
8 mm  
10 mm  
12 mm  
20 mm

- Crystal**
- Crystal M HF (001)
- Colors**
- Plain Colors**
- Jet M HF (280)
- Crystal Effects**
- Crystal AB M HF (001 AB)
- Crystal Golden Shadow M HF (001 GSHA)
- Crystal Patina**
- Crystal Black Patina M HF (001 BLAPA)
- Crystal Gold Patina M HF (001 GOLPA)
- Crystal Rose Patina M HF (001 ROSPA)
- Crystal Silver Patina M HF (001 SILPA)
- Crystal White Patina M HF (001 WHIPA)

## 2510 Baguette Flat Back



Size  
5x2.5 mm

- Crystal**
- Crystal M HF (001)
- Colors**
- Plain Colors**
- Jet M HF (280)
- Crystal Effects**
- Transparent Effects**
- Crystal AB M HF (001 AB)
- Color Effects**
- Metallic Effects**
- Jet Hematite M HF (280 HEM)



# Flat Backs Hotfix

## 2520 Cosmic Flat Back



**Size**

- 8x6 mm
- 10x8 mm
- 14x10 mm

**Crystal**

- Crystal M HF (001)

## 2555 Cosmic Baguette Flat Back

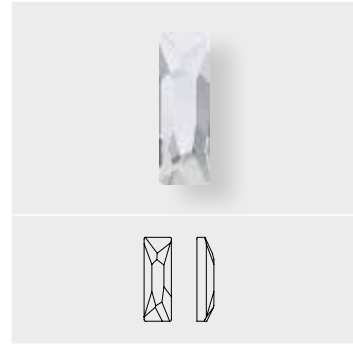

**Size**

- 8x2.6 mm
- 12x4 mm
- 15x5 mm

**Crystal**

- Crystal M HF (001)

**Colors**

**Plain Colors**

- Jet M HF (280)

**Crystal Effects**

**Transparent Effects**

- Crystal AB M HF (001 AB)
- Crystal Golden Shadow M HF (001 GSHA)
- Crystal Silver Shade M HF (001 SSHA)

## 2585 Graphic Flat Back



**Size**

- 8 mm
- 10 mm
- 14 mm

**Crystal**

- Crystal M HF (001)

**Colors**

**Plain Colors**

- Denim Blue M HF (266)

## 2610 Rectangle Flat Back



**Size**

- 6x4 mm

**Crystal**

- Crystal M HF (001)

**Color Effects**

**Metallic Effects**

- Jet Hematite M HF (280 HEM)

# Flat Backs Hotfix

## 2611 Solaris Flat Back

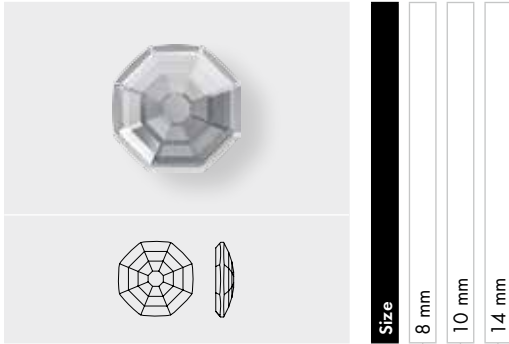

Size  
8 mm  
10 mm  
14 mm

Crystal			
Crystal M HF (001)	■	■	■
Colors			
Plain Colors			
Aquamarine M HF (202)	■	■	■
Jet M HF (280)	■	■	■
Light Rose M HF (223)	■	■	■
Crystal Effects			
Transparent Effects			
Crystal AB M HF (001 AB)	■	■	■
Crystal Golden Shadow M HF (001 GSHA)	■	■	■
Crystal Luminous Green M HF (001 LUMG)	■	■	■
Crystal Silver Night M HF (001 SINI)	■	■	■
Metallic Effects			
Crystal Iridescent Green M HF (001 IRIG)	■	■	■

## 2611/G Solaris Flat Back partly frosted

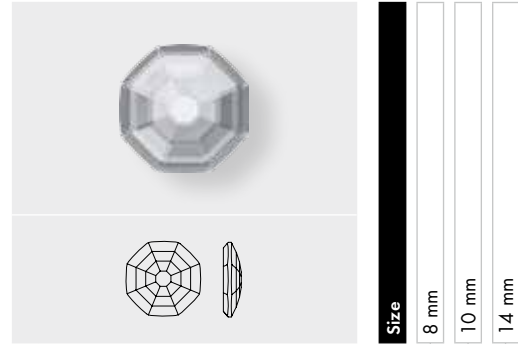

Size  
8 mm  
10 mm  
14 mm

Crystal			
Crystal M HF (001)	■	■	■
Colors			
Plain Colors			
Aquamarine M HF (202)	■	■	■
Jet M HF (280)	■	■	■
Light Rose M HF (223)	■	■	■
Crystal Effects			
Transparent Effects			
Crystal AB M HF (001 AB)	■	■	■
Crystal Golden Shadow M HF (001 GSHA)	■	■	■
Crystal Luminous Green M HF (001 LUMG)	■	■	■
Crystal Silver Night M HF (001 SINI)	■	■	■
Metallic Effects			
Crystal Iridescent Green M HF (001 IRIG)	■	■	■

# Flat Backs Hotfix

## 2708 Molecule Flat Back

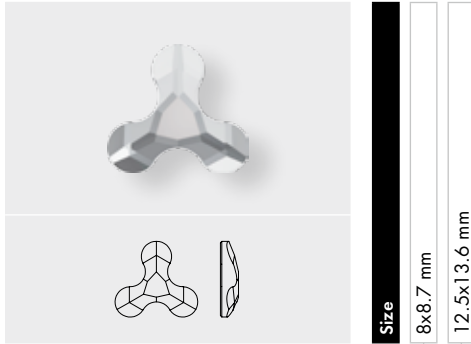

**Size**  
8x8.7 mm  
12.5x13.6 mm

- Crystal**
- Crystal M HF (001)
- Colors**
- Plain Colors**
- Amethyst M HF (204)
- Blue Zircon M HF (229)
- Dark Moss Green M HF (260)
- Denim Blue M HF (266)
- Fuchsia M HF (502)
- Jet M HF (280)
- Light Silk M HF (261)
- Light Turquoise M HF (263)
- Crystal Effects**
- Transparent Effects**
- Crystal AB M HF (001 AB)
- Crystal Antique Pink M HF (001 ANTP)
- Crystal Blue Shade M HF (001 BLSH)
- Crystal Golden Shadow M HF (001 GSHA)
- Crystal Silver Night M HF (001 SINI)
- Metallic Effects**
- Crystal Iridescent Green M HF (001 IRIG)
- Crystal Rose Gold M HF (001 ROGL)

## 2709 Rhombus Flat Back

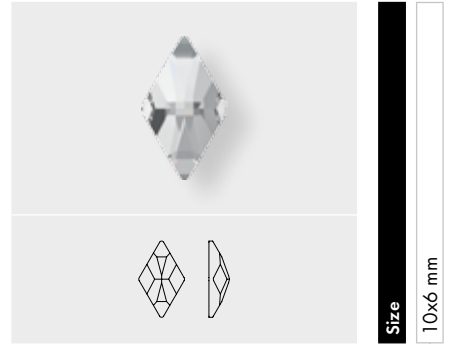

**Size**  
10x6 mm

- Crystal**
- Crystal M HF (001)
- Colors**
- Plain Colors**
- Black Diamond M HF (215)
- Jet M HF (280)
- Light Siam M HF (227)
- Crystal Effects**
- Transparent Effects**
- Crystal AB M HF (001 AB)
- Crystal Golden Shadow M HF (001 GSHA)

# Flat Backs Hotfix

### 2711 Triangle Flat Back

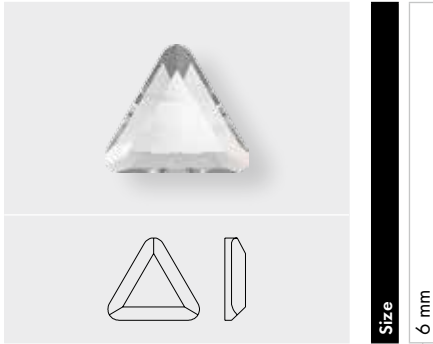

Size  
6 mm

- Crystal**
- Crystal M HF (001)
- Colors**
- Plain Colors
- Jet M HF (280)
- Crystal Effects**
- Transparent Effects
- Crystal AB M HF (001 AB)
- Color Effects**
- Metallic Effects**
- Jet Hematite M HF (280 HEM)

### 2716 Rivoli Triangle Flat Back

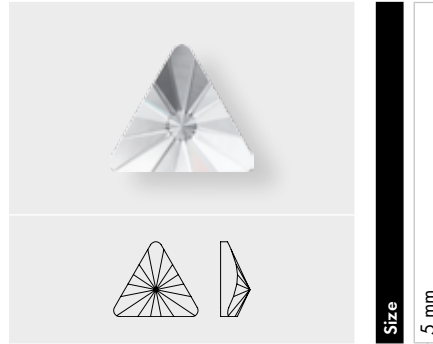

Size  
5 mm

- Crystal**
- Crystal M HF (001)
- Crystal Effect**
- Transparent Effects
- Crystal AB M HF (001 AB)

### 2720 Cosmic Delta Flat Back

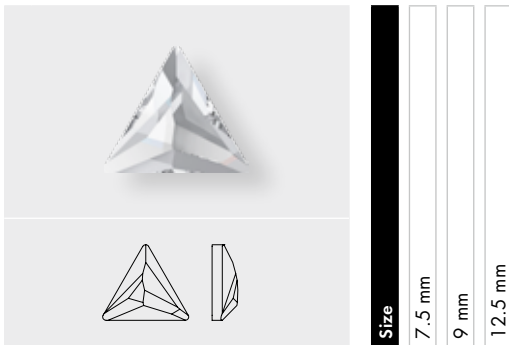

Size  
7.5 mm  
9 mm  
12.5 mm

- Crystal**
- Crystal M HF (001)
- Colors**
- Plain Colors
- Jet M HF (280)
- Crystal Effects**
- Transparent Effects
- Crystal AB M HF (001 AB)
- Crystal Silver Shade M HF (001 SSHA)

### 2728 Marguerite Flat Back



Size  
SS 10  
SS 16  
SS 20  
SS 34

- Crystal**
- Crystal M HF (001)
- Crystal Effect**
- Transparent Effects
- Crystal AB M HF (001 AB)

# Flat Backs Hotfix

## 2770 Wing Flat Back

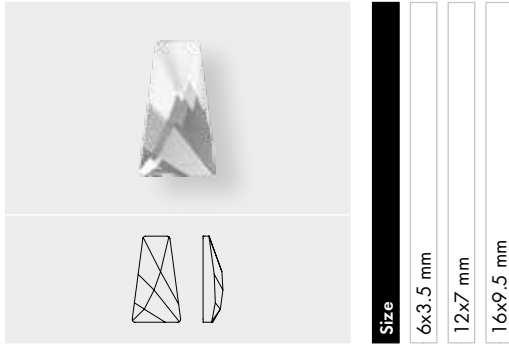

**Size**  
6x3.5 mm  
12x7 mm  
16x9.5 mm

**Crystal**

Crystal M HF (001)

**Colors**

**Plain Colors**

Black Diamond M HF (215)

Jet M HF (280)

**Crystal Effects**

**Transparent Effects**

Crystal AB M HF (001 AB)

Crystal Golden Shadow M HF (001 GSHA)

## 2788 Wave Flat Back

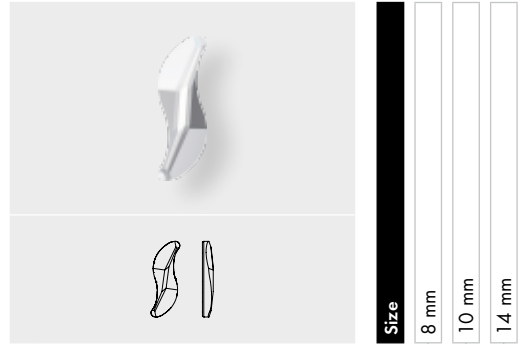

**Size**  
8 mm  
10 mm  
14 mm

**Crystal**

Crystal M HF (001)

**Crystal Effects**

**Transparent Effects**

Crystal AB M HF (001 AB)

Crystal Blue Shade M HF (001 BLSH)

## 2797 Diamond Leaf Flat Back

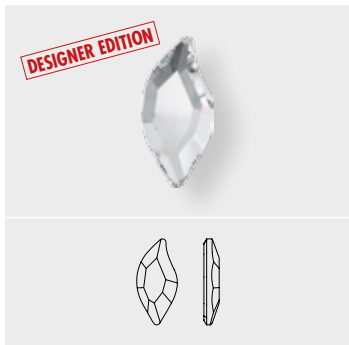

**Size**  
8x4 mm

**Crystal**

Crystal M HF (001)

**Crystal Effect**

**Transparent Effects**

Crystal AB M HF (001 AB)

# Flat Backs Hotfix

## 2808 Heart Flat Back

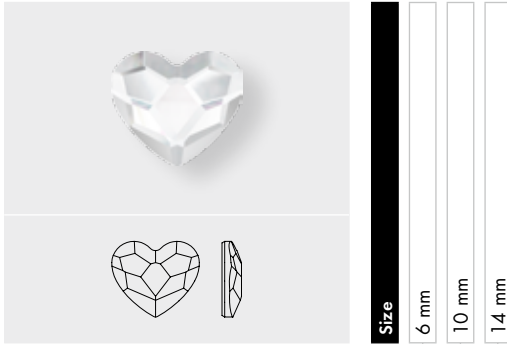

Crystal	6 mm	10 mm	14 mm
Crystal M HF (001)	■	■	■
<b>Colors</b>			
<b>Plain Colors</b>			
Dark Moss Green M HF (260)	■	■	■
Denim Blue M HF (266)	■	■	■
Fuchsia M HF (502)	■	■	■
Jet M HF (280)	■	■	■
Light Siam M HF (227)	■	■	■
Light Silk M HF (261)	■	■	■
Rosaline M HF (508)	■	■	■
<b>Crystal Effects</b>			
<b>Transparent Effects</b>			
Crystal AB M HF (001 AB)	■	■	■
Crystal Antique Pink M HF (001 ANTP)	■	■	■
Crystal Astral Pink M HF (001 API)	■	■	■
Crystal Golden Shadow M HF (001 GSHA)	■	■	■
<b>Metallic Effects</b>			
Crystal Rose Gold M HF (001 ROGL)	■	■	■
<b>Crystal Patina</b>			
Crystal Black Patina M HF (001 BLAPA)	■	■	■
Crystal Gold Patina M HF (001 GOLPA)	■	■	■
Crystal Rose Patina M HF (001 ROSPA)	■	■	■
Crystal Silver Patina M HF (001 SILPA)	■	■	■
Crystal White Patina M HF (001 WHIPA)	■	■	■

## 2816 Rivoli Star Flat Back

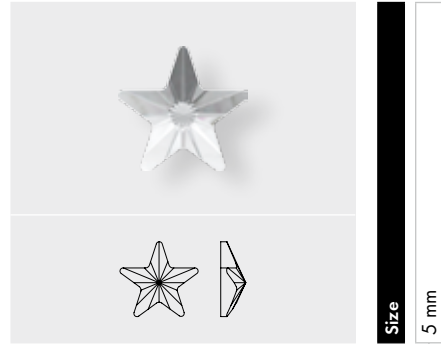

Crystal	5 mm	10 mm
Crystal M HF (001)	■	■
<b>Colors</b>		
<b>Plain Colors</b>		
Jet M HF (280)	■	■
<b>Crystal Effects</b>		
<b>Transparent Effects</b>		
Crystal AB M HF (001 AB)	■	■
<b>Color Effects</b>		
<b>Metallic Effects</b>		
Jet Hematite M HF (280 HEM)	■	■

# Flat Backs Hotfix

## 2817 Star Flat Back

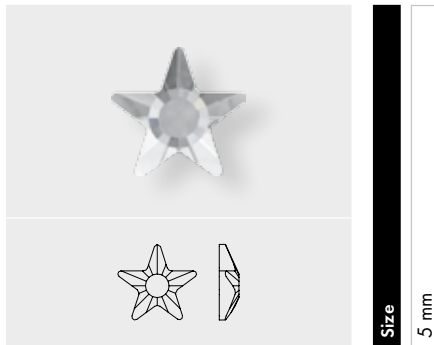

- Crystal**
- Crystal M HF (001)
- Colors**
- Plain Colors**
- Denim Blue M HF (266)
- Jet M HF (280)
- Rose Peach M HF (262)
- Crystal Effects**
- Transparent Effects**
- Crystal AB M HF (001 AB)
- Crystal Golden Shadow M HF (001 GSHA)
- Crystal Silver Night M HF (001 SINI)
- Metallic Effects**
- Crystal Iridescent Green M HF (001 IRIG)
- Crystal Rose Gold M HF (001 ROGL)
- Color Effects**
- Metallic Effects**
- Jet Hematite M HF (280 HEM)

## 2826 Rivoli Snowflake Flat Back

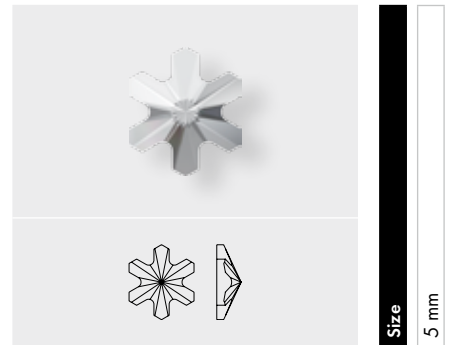

- Crystal**
- Crystal M HF (001)
- Crystal Effect**
- Transparent Effects**
- Crystal AB M HF (001 AB)

# Flat Backs Hotfix

## 2855 Butterfly Flat Back

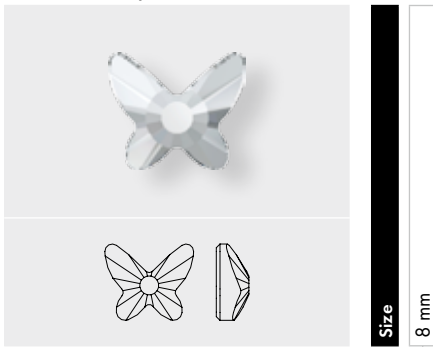

- Crystal**
- Crystal M HF (001)
- Colors**
- Plain Colors**
- Amethyst M HF (204)
- Denim Blue M HF (266)
- Jet M HF (280)
- Light Rose M HF (223)
- Rose Peach M HF (262)
- Crystal Effects**
- Transparent Effects**
- Crystal AB M HF (001 AB)
- Crystal Golden Shadow M HF (001 GSHA)
- Crystal Luminous Green M HF (001 LUMG)
- Crystal Silver Night M HF (001 SINI)

## 2855/G Butterfly Flat Back fully frosted

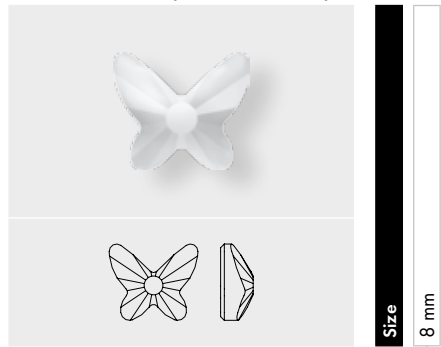

- Crystal**
- Crystal M HF FF (001)
- Colors**
- Plain Colors**
- Amethyst M HF FF (204)
- Denim Blue M HF FF (266)
- Light Rose M H F FF (223)
- Rose Peach M HF FF (262)



# Flat Backs Hotfix

## 2858 Bow Tie Flat Back



	6x4.5 mm	9x6.5 mm	12x8.5 mm
<b>Crystal</b>			
Crystal M HF (001)	■	■	■
<b>Colors</b>			
<b>Plain Colors</b>			
Denim Blue M HF (266)	■	■	■
Jet M HF (280)	■	■	■
Light Amethyst M HF (212)	■	■	■
Light Siam M HF (227)	■	■	■
Tangerine M HF (259)	■	■	■
Vintage Rose M HF (319)	■	■	■
<b>Opal Colors</b>			
White Opal M HF (234)	■	■	■
<b>Crystal Effects</b>			
<b>Transparent Effects</b>			
Crystal AB M HF (001 AB)	■	■	■
Crystal Golden Shadow M HF (001 GSHA)	■	■	■
Crystal Luminous Green M HF (001 LUMG)	■	■	■
Crystal Silver Night M HF (001 SINII)	■	■	■
<b>Metallic Effects</b>			
Crystal Iridescent Green M HF (001 IRIG)	■	■	■

# Flat Backs Hoffix

## PRODUCT DETAILS

Article Size	Packing Unit = Minimum Order Quantity in Pieces	Average Net Weight in Gram per Packing Unit Crystal (001)	Average Gross Weight in Gram per Packing Unit Crystal (001)
<b>2000 A HF</b>			
SS 3	1,440	1.8	12.7
<b>2035 M HF</b>			
6 mm	360	27.1	34.8
10 mm	192	56.2	88.0
14 mm	96	88.4	109.9
20 mm	40	82.0	121.4
<b>2037 M HF</b>			
8 mm	240	14.48	23.58
14 mm	72	12.05	39.99
17 mm	72	27.72	52.20
<b>2038 A HF</b>			
SS 5	1,440	4.18	12.15
SS 6	1,440	5.45	17.66
SS 8	1,440	9.96	18.22
SS 10	1,440	15.54	24.33
<b>2038/B</b>			
SS 8	1,440	9.96	18.22
SS 10	1,440	15.54	24.33
SS 12	1,440	21.59	30.36
SS 16	1,440	39.09	47.11
SS 20	1,440	71.98	79.58
<b>2078 A HF</b>			
SS 12	1,440	21.59	30.36
SS 16	1,440	39.09	47.11
SS 20	1,440	71.98	79.58
SS 30	288	34.56	63.02
SS 34	144	25.92	48.59
SS 40	144	43.2	66.87
SS 48	96	61.44	87.41
<b>2080/4 HF</b>			
SS 10	1,440	17.1	28.3
SS 16	1,440	43.4	54.9
SS 34	144	23.2	34.1
<b>2200 M HF</b>			
8x4 mm	360	24.8	35.8
<b>2204 M HF</b>			
6x4.8 mm	360	27.237	36.368
10x8 mm	144	31.450	53.332
14x11 mm	108	52.618	74.012
<b>2300 M HF</b>			
8x4.8 mm	360	41.9	51.0
<b>2400 M HF</b>			
3 mm	1,440	25.3	36.8
4 mm	720	30.0	41.0
<b>2483 M HF</b>			
10 mm	144	89.19	119.00
<b>2493 M HF</b>			
8 mm	216	72.3	91.8
10 mm	144	84.4	106.1
12 mm	96	96.4	127.8
20 mm	24	108.5	137.9

# Flat Backs Hotfix

Article Size	Packing Unit = Minimum Order Quantity in Pieces	Average Net Weight in Gram per Packing Unit Crystal (001)	Average Gross Weight in Gram per Packing Unit Crystal (001)
<b>2510 M HF</b> 5x2.5 mm	720	23.2	32.3
<b>2520 M HF</b> 8x6 mm	288	50.81	80.25
10x8 mm	144	72.32	94.20
14x10 mm	144	119.32	145.24
<b>2555 M HF</b> 8x2.6 mm	240	18.4	27.5
12x4 mm	144	28.8	33.6
15x5 mm	72	28.9	46.0
<b>2585 M HF</b> 8 mm	288	48.21	68.08
10 mm	288	72.32	104.28
14 mm	144	106.06	145.52
<b>2610 M HF</b> 6x4 mm	360	23.5	34.3
<b>2611 M HF</b> 8 mm	144	29.400	68.08
10 mm	216	93.623	104.28
14 mm	48	42.336	145.52
<b>2611/G M HF</b> 8 mm	144	29.400	68.08
10 mm	216	93.623	104.28
14 mm	48	42.336	145.52
<b>2708 M HF</b> 8x8.7 mm	288	28.063	57.335
12.5x13.6 mm	96	49.318	69.271
<b>2709 M HF</b> 10x6 mm	288	28.93	67.23
<b>2711 M HF</b> 6 mm	360	29.7	40.7
<b>2716 M HF</b> 5 mm	720	35.78	75.11
<b>2720 M HF</b> 7.5 mm	240	27.9	37.0
9 mm	180	45.1	54.2
12.5 mm	144	71.1	87.1
<b>2728 M HF</b> SS 10	1,440	14.1	24.6
SS 16	1,440	38.0	48.8
SS 20	1,440	65.7	76.5
SS 34	144	26.5	37.5
<b>2770 M HF</b> 6x3.5 mm	1,440	60.3	70.3
12x7 mm	192	49.8	98.4
16x9.5 mm	72	48.8	77.7
<b>2788 M HF</b> 8 mm	288	7.54	18.43
10 mm	216	10.54	37.75
14 mm	144	16.99	45.07

# Flat Backs Hotfix

09 Flat Backs Hotfix

Article Size	Packing Unit = Minimum Order Quantity in Pieces	Average Net Weight in Gram per Packing Unit Crystal (001)	Average Gross Weight in Gram per Packing Unit Crystal (001)
<b>2797 M HF</b> 8x4 mm	240	14.9	24.0
<b>2808 M HF</b> 6 mm	288	19.772	28.919
10 mm	144	38.823	55.902
14 mm	96	56.448	86.849
<b>2816 M HF</b> 5 mm	720	23.56	30.69
<b>2817 M HF</b> 5 mm	720	21.915	31.063
<b>2826 M HF</b> 5 mm	720	23.06	30.07
<b>2855 M HF</b> 8 mm	216	46.79	55.93
<b>2855/G M HF</b> 8 mm	216	46.79	55.93
<b>2858 M HF</b> 6x4.5 mm	240	12.51	21.66
9x6.5 mm	144	23.39	44.05
12x8.5 mm	96	28.71	49.79

